

# Packaged Pressure Booster Systems

IVS Booster Systems  
with Standard Controller

Installation and  
operating instructions

File No: 62.803  
Date: NOVEMBER 26, 2015  
Supersedes: 62.803  
Date: AUGUST 11, 2014

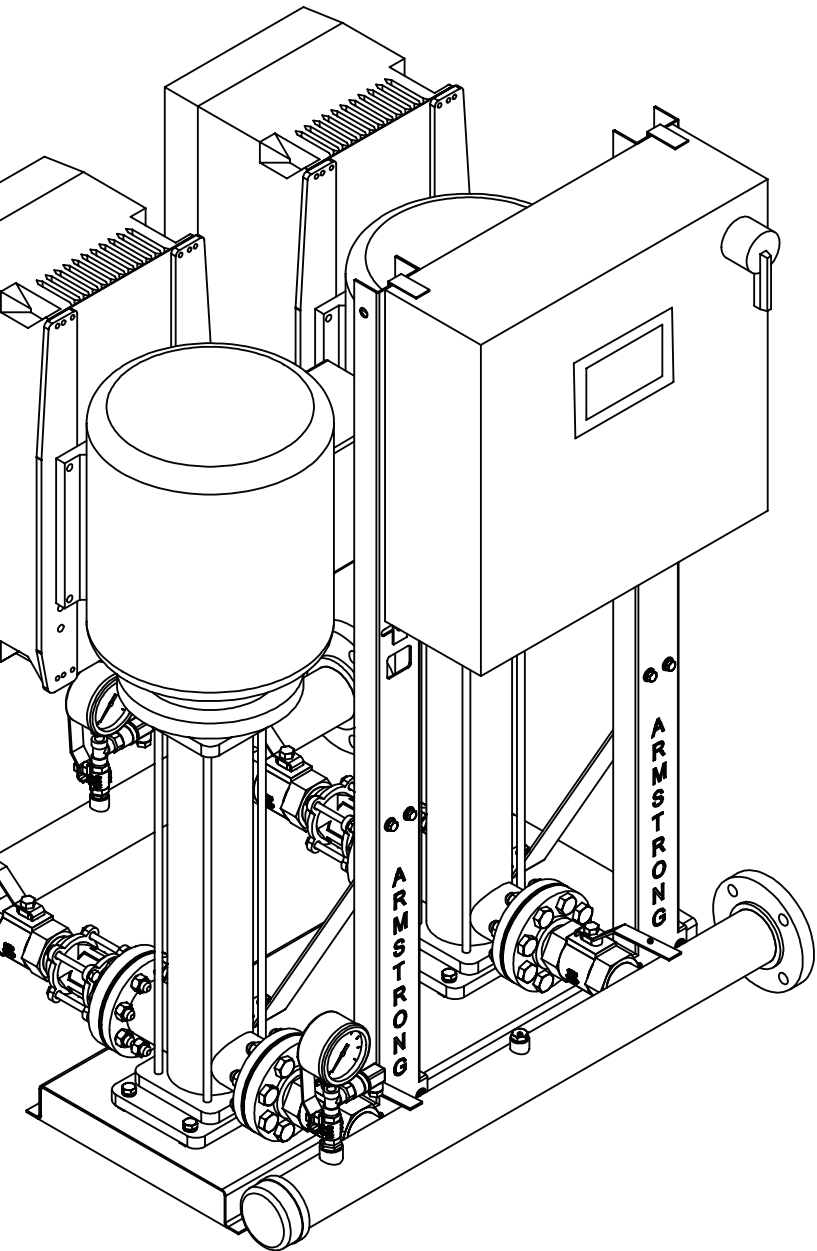

—

—

—

—

# CONTENTS

ivs booster systems installation instructions	4
Intelligent variable speed booster systems: Basic operating function	4
Variable speed booster systems: General arrangement schematic diagram	6
ivs booster package commission check sheet	7
<b>1.0</b> Installation instructions	11
<b>1.1</b> Operation screens	12
<b>1.2</b> Alarm management screens	15
<b>1.2</b> Level 0 setup screens	16
<b>2.0</b> Installer screens	19
<b>2.1</b> Operation screens	19
<b>2.2</b> Alarm management screens	19
<b>2.3</b> Level 1 setup screens	19
<b>3.0</b> Factory screens	26
<b>3.1</b> Operation screens	26
<b>3.2</b> Alarm management screens	26
<b>3.2</b> Level 2 setup screens	26
<b>4.0</b> System start-up procedure	26
Wiring diagram	31

Armstrong Packaged Pressure Booster systems are completely factory-assembled, tested, adjusted, and shipped to the job site as integral units ready to receive suction and discharge piping and incoming power supply. These instructions describe the procedures to be followed during installation, commissioning and operation to ensure optimum performance and reliability. When contacting the factory for assistance, please provide the unit serial number and other pertinent data, such as motor amperage, voltage and suction and discharge pressures.

## A DESIGN ENVELOPE BOOSTER SYSTEMS INSTALLATION INSTRUCTIONS

**Storage** - Make sure that all components are kept as clean as possible. Do not remove the crating or plastic wrapping until the unit is ready for installation.

**Uncrating** - After removal of the unit from the crate, check to see that the equipment is in good order and that all components are received as called for on the packing slip. Any shortages or damage should be reported immediately.

**Location** - Locate the unit where it is easily accessible for inspection and servicing. Provide adequate room for pump withdrawal and also for access to the interior of the control panel.

**Foundation** - The foundation should be sufficiently substantial to absorb any vibration and to form a permanent rigid support for the base plate. A good concrete foundation should be approximately 2½ times the weight of the packaged unit.

**Foundation bolts** - Foundation bolts of the proper size should be arranged as shown in the sketch, with a pipe sleeve embedded in the concrete to permit adjustment of the bolts after the concrete has been poured. Use sleeves with a diameter 2½ times the diameter of bolts.

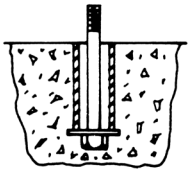

**Leveling** - When the unit has been placed on its foundation, insert metal wedges approximately 1" thick on either side of the foundation bolts under the base plate. Adjust the wedges until the suction and discharge headers are truly horizontal. Check this by means of a spirit level on the suction and discharge flanges. When leveling is complete, the foundation bolts should

be tightened evenly and firmly. Do not over tighten the bolts at this stage.

**Piping** - Both the suction and discharge pipes should be independently supported so that no strain is imposed on the packaged unit when the pipes are connected. All connecting pipe work should be accurately located-do not attempt to force the suction and discharge pipes into position.

**Incoming Supply** - The incoming power supply should be brought in through the top of the panel adjacent to the main terminals. Note that this is the only electrical connection required at the panel.

**Adjustments** - The touch display Interface provides access for the adjustable set points, alarms and timers. No other devices require adjustments.

The operation and adjustment procedures for the set points, alarms and timers are described in the manual.

Note carefully, however, that all devices are pre-set at the factory and will normally require no further adjustment.

**Automatic operation and Initial Run** - To set the unit for automatic operation, turn all the isolating valves to the fully open position, close the main disconnect, all pumps are already in the **AUTO** position, all drives are already in the Auto On position so go to the setup screen, log in, put the Remote/Local start switch in Local position and the booster system will run. If start/stop of the booster is control by the remote BAS dry contact switch put the Remote/Local start switch in Remote position and close BAS remote switch. **In initial run check for noise, vibration, etc., and any leaks in the pipework.**

## B INTELLIGENT VARIABLE SPEED BOOSTER SYSTEMS: BASIC OPERATING FUNCTION

Every Armstrong Intelligent variable speed (Design Envelope) Packaged system – regardless of size or horse power rating – incorporates the twelve (12) basic operating functions as follows:

- 1 For Continuous run and Intermittent systems - Sequential starting and stopping of the pumps is achieved by a combination of pump speed, power and set point pressure. A set point pressure control will bring on a lag pump if the lead pump(s) are operating at full speed and not maintaining set point pressure. When the lead pump reaches 100% speed or maximum motor nameplate power and the system pressure is not being satisfied, the second pump (lag pump) is automatically started. When a lag pump is started up, a timeclock in the pump controller keeps it operating for

a minimum of a 1 minute period to prevent the pump from cycling on and off. On a three, four or five pump system, the third, fourth and fifth pumps are brought on in the same way when the combined pumps reach 100% speed or maximum motor nameplate power and the system pressure is not being satisfied. A similar sequence of events takes place in reverse on decreasing demand.

- 2 Pump RPM is controlled by a Variable Frequency Drive (VFD) connected directly to each individual pump motor. An analog signal from the discharge pressure transmitter is compared to a desired set point entered in to the operator panel. The pump logic controller then instructs the VFD to either speed up or slow down in order to meet or maintain the system set point pressure.
- 3 A low suction pressure or level shutdown alarm is included with every system to protect the pumps from a loss of suction pressure or water supply. If the water supply pressure, as measured by the suction pressure transmitter falls to 5 psi or the tank level switch (supplied by other) sends a signal to the panel, the pump controller will prevent the pumps from running. This condition is indicated by a **low suction pressure** or **low suction level** alarm description on the control panel alarm page.
- 4 To protect plumbing the booster come with standard alarm functions for:
  - High discharge pressure shutdown
  - Low discharge pressure shutdown
- 5 Should a motor or drive overload and fail to operate, the next pump in sequence starts up automatically.
- 6 Lead pump status is alternated after every 24 hrs of operation, as a default. The first pump placed in the auto position is considered the lead pump. Hand off-Auto switches are located in the individual pump control screens. Alternation includes all duty and optional standby pumps.
- 7 No-flow shut down is achieved through drive parameter control and pressure monitoring. Once a no-demand condition is achieved for a period of 5 minute, the controller will increase the pump speed and charge the drawdown tank or system an additional 5 psi before shutting down.
- 8 In every system restart, once started, the pumps ramp up to meet the required set point pressure.
- 9 The Soft fill mode is enabled when the booster system is first powered and after any power disruption. Once started,

the pumps ramp up slowly from the Soft Fill set point pressure to nominal pressure in a five minute period.

- 10 The Pressure Setback Mode is enabled as standard. The system pressure set point is reduced linearly, as a percentage, as flow decreases.
- 11 When the Emergency power mode is enabled and upon receiving an Emergency Power digital signal, power and control will be restricted to the lead pump only, the Low system pressure shutdown will be disabled and the Emergency power low system pressure alarm will be enabled. The one pump will operate for the duration of the Emergency power mode and the system will switch to Normal Mode when a signal is not present.
- 12 Variable speed controllers are supplied with 3 analog inputs and 8 digital Normally Open (NO) dry contacts for remote monitoring. The contacts are located on the upper left hand portion of the pump controller and indicate the following conditions:  
**Analog**
  - 1, 2 - Discharge pressure transducer
  - 3, 4 - Suction pressure transducer (optional)
  - 5, 6 - Remote pressure transducer (optional)**Digital**
  - 7, 8 - Remote start (optional)
  - 9, 10 - Emergency power (optional)
  - 11, 12 - Use alternate setpoint 1 (optional)
  - 13, 14 - Use alternate setpoint 2 (optional)
  - 15, 16 - Use alternate setpoint 3 (optional)
  - 17, 18 - Use aquastat (optional)/  
Alternate setpoint 4 (optional)
  - 19, 20 - Use level switch 1 (optional)/  
Alternate setpoint 5 (optional)
  - 21, 22 - Use level switch 2 (optional)/  
Alternate setpoint 6 (optional)

Communication option

(Serial connection except for BACnet (IP/ENET))

29,30 – BAS communication

GDN – BAS/VFD Ground

33,34 – VFD communication

**C VARIABLE SPEED BOOSTER SYSTEMS:  
GENERAL ARRANGEMENT SCHEMATIC DIAGRAM**

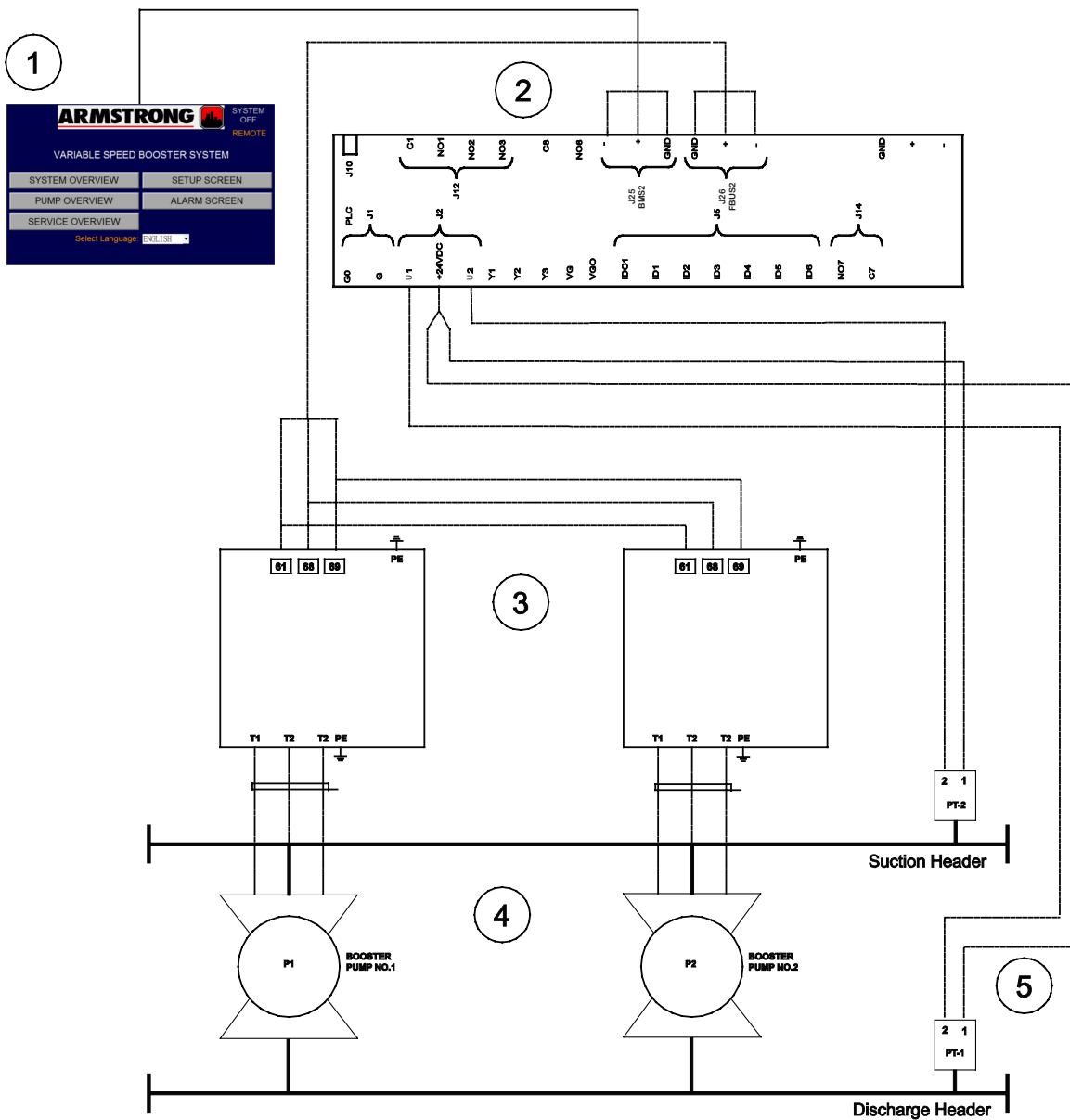

- 1 Operator Interface
- 2 Programmable Logic Controller (PLC)
- 3 Variable Frequency Drives (VFD)
- 4 Booster Pumps
- 5 Pressure Transmitters

## D DESIGN ENVELOPE BOOSTER PACKAGE COMMISSION CHECK SHEET

The following is a step-by-step guide to starting up and commissioning Armstrong fire pumps. **One check sheet is to be completed per system!** You must follow and fill out all fields below to ensure that all aspects of the booster is checked and set up for proper operation. Once complete, this sheet requires that end-user / general contractor sign off on the work rendered as final approval that the

pump is functioning as intended. Please submit this commissioning check sheet along with your work invoice / startup claim in order to ensure prompt and timely payment of work rendered!

**NO CHECK SHEET + STARTUP DATA SHEET = INCOMPLETE STARTUP!  
UNLESS STATED OTHERWISE ALL FIELDS ARE MANDATORY!**

Project name:	_____		
Building address:	_____		
Contractor name:	_____		
Site contact name:	_____	Site contact tel. #:	_____
Your company:	_____	Your name:	_____
Pump model:	_____	Booster serial #:	_____
Pump serial #(s):	_____	Sales order #:	_____

**NOTES:**

- GC = General Contractor
- BAS = Building Automation System

**PRE-STARTUP PACKAGE:**

YES	NO	N/A	
<input type="checkbox"/>	<input type="checkbox"/>	<input type="checkbox"/>	Do you have the Booster Order Annexe?
<input type="checkbox"/>	<input type="checkbox"/>	<input type="checkbox"/>	Do you have a copy of the electrical wiring diagram?
<input type="checkbox"/>	<input type="checkbox"/>	<input type="checkbox"/>	Do you have a copy of the Design Envelope Booster Installation and Operation Manual?
<input type="checkbox"/>	<input type="checkbox"/>	<input type="checkbox"/>	OPTIONAL: Do you have the pump-specific variable speed curve with duty point indicated?

**PRE-STARTUP ARRANGEMENTS:**

YES	NO	N/A	
<input type="checkbox"/>	<input type="checkbox"/>	<input type="checkbox"/>	Verify with GC that water and power is available and ready to the pump
<input type="checkbox"/>	<input type="checkbox"/>	<input type="checkbox"/>	Verify with GC that pumps can be run without damage to system
<input type="checkbox"/>	<input type="checkbox"/>	<input type="checkbox"/>	Verify with GC that BAS is wired to Design Envelope Booster controller and ready to go (if applicable)
<input type="checkbox"/>	<input type="checkbox"/>	<input type="checkbox"/>	Verify with GC that BAS contractor will be there on site to meet you (if applicable)

**BEFORE POWER UP CHECKLIST:**

**DONE**

- Check booster installation for proper mounting as per Installation & Operation Manual instructions
- Check incoming voltage across the lines and record here: L1 \_\_\_\_\_ L2 \_\_\_\_\_ L3 \_\_\_\_\_  
Note: Voltage should be no more than±10% of design voltage
- Check if booster set is to be controlled remotely by BAS start / stop remote contact with BAS contractor:
  - YES:** Check if BAS remote dry contact is wired across terminals 7 & 8 inside control panel.
  - NO:** Move on to the next step.  
Note: Contacts close = booster runs. Contacts open = booster stops.
- Open up and bleed pump seal flush line to verify no air is locked inside seal / seal lines. If the pumps are Vertical Multi Stage (VMS) pumps, make sure the vertical column is bled for air by cracking open the bolt located at the top of the stages.
- Check alignment of pump (horizontally mounted pumps only)
- Record the actual suction pressure from the gauge here: Suction \_\_\_\_\_  
Verify if suction pressure is within range of design suction pressure on Order Annex.

### BOOSTER PANEL PARAMETER CHECKLIST:

Begin the commissioning by logging into the **Setup** screen with the Level 1 password. Go through all parameters, verify against the order annex and record below.

**IMPORTANT:** Pressing **Restore** button in a setting screen will Restore the Default settings on same screen. The text will change to **OK** for a few seconds

**Parameter definition:** (min, max, default)

**NOTE:**

pressure units default to psi, but in the controller users can also select bar, kPa, ft and m.

#### Factory adjustable settings

- Number of Pumps (2, 5, based on package configuration)
- Standby pump (Yes or No, No)
- Level switch 1 (Enable or Disable, Disable)
- Level switch 2 (Enable or Disable, Disable)
- Drive type (FC102 or FCM300, FC102)
- Motor frequency (50 or 60, 60) Hz
- Lead pump switch time (1, 168, 24) hours of lead pump operation time
- Pump rated power (1,40,based on package configuration) kW
- (Pressure) units (psi, ft, kPa, m, bar) psi
- Suction pressure sensor (Enable or Disable, Enable)
- Suction pressure sensor Range (0, 3200, 300) psi
- Discharge pressure sensor (Enable or Disable, Enable)
- Discharge pressure sensor Range (0, 3200, 300) psi
- Remote pressure sensor (Enable or Disable, Disable)
- Remote pressure sensor range (0, 3200, 300) psi
- Local discharge pressure setpoint (0, max working pressure, based on order) psi.
- Remote discharge pressure setpoint (0, max working pressure, based on order) psi. It appears only if the Remote Sensor is enabled.
- System discharge pressure setpoint (it's one of the previous two (depending on which sensor is selected as Control Sensor) or one of six the Alternate Discharge pressure setpoints (depending on PLC digital input selection))
  - (Choose) Control Sensor (LOCAL or REMOTE, LOCAL)
  - **Update limits** or **Auto set pressure limits** updates (sets up) all pressure limits and No flow shutdown boost pressure proportionally to the System discharge pressure setpoint.
  - High suction pressure limit (low suction pressure shutdown + 5, max working pressure, System discharge pressure Setpoint - 10) psi. It is updated (setup) by pressing **Update limits**. High suction pressure limit (Disable or Enable, Enable).
  - Low suction pressure limit (0, System pressure setpoint, 5) psi. It is updated (setup) by pressing **Update limits**.
  - High discharge pressure limit (low system pressure + 5, max working pressure, System discharge pressure setpoint + 15) psi. It is updated (setup) by pressing **Update limits**. High Discharge Pressure Limit (Disable or Enable, Disable).
  - Emergency Power mode low discharge pressure limit (0, System discharge pressure setpoint \* 0.5, System discharge pressure setpoint \* 0.2). It is updated (setup) by pressing **Update limits**.
  - Factory High system shutdown pressure (max working pressure, max working pressure, 200) psi. Maximum Working Pressure, choice of 175, 200, 232, 370 or 400 psi, based on package configuration.
  - Low discharge pressure limit (0, System discharge pressure setpoint \* 0.8, Pressure Setback at start \* 0.8) psi. It is updated (setup) by pressing **Update limits**.
  - Number of Alternate discharge setpoints (0, 6, 0)
  - Alternate discharge pressure setpoint 1 to 6 (0, max working pressure, System discharge pressure setpoint) psi.
  - Emergency power mode (Enable or Disable, Disable)
  - Number of running pumps in Emergency (0,5,1)
  - eoc (End of Curve) Protection (Enable or Disable, Disable)
  - eoc (End of Curve) Head coefficient (0, 100, 90) % of Local discharge pressure
  - Aquastat protection (Enable or Disable, Disable)
  - Airlock protection (Enable or Disable, Disable)
  - Airlock shutdown pump power setpoint (0 to 30, 15) % Pump rated power
  - Airlock shutdown delay (0, 600, 20) sec
  - Pump stage on speed (33, 100, 100) % speed
  - Pump stage off by selector (Speed, Power, Speed or Power, Speed and Power), default is Speed and Power



- Pump stage off speed (33, 98, 70) % speed
- Pump stage off power (70, 200, 90) % power (see Normal mode for description)
- Pump stage on delay (0,999,10) seconds
- Pump stage off delay (0,999,30) seconds
- Soft fill mode (Disable or Enable, Enable).
- Soft fill pressure setpoint (20, 100, 30) % of System discharge pressure setpoint
- Soft fill ramp time (0,999,120) seconds
- No flow shutdown (Disable or Enable, Enable).
- No flow shutdown delay (0,999,300) seconds
- No flow shutdown speed/Power (Power or Speed, Power)
- No flow shutdown speed/Power (0, 100, 95) % Power/speed
- No flow shutdown wait time (0,999,60) seconds
- No flow shutdown set speed (0, 100, 70) % speed
- No flow shutdown boost pressure (0, max working pressure - System discharge pressure setpoint, 5) psi. It is updated (setup) by pressing **Update limits** after Pressure units are selected. Setup is 5 psi or 11 ft or 35kPa or 3.5m or 0.34bar.
- Pump minimum speed setpoint (0, 98, 40) % speed
- Pump maximum speed setpoint (0, 100, 100) % speed
- Pump ramp (5,15,15) seconds
- Pump default speed (0,100,70)% when all discharge sensors fail and the aquastat is enabled
- Pump motor rated RPM (0,9999,1780) rpm
- PLC PID Proportional gain (1, 99, 10) %/sec
- PLC PID Speed up limit (0.2, 99.9, 1.0) %/sec
- PLC PID Speed down limit (0.2, 99.9, 3.0) %/sec
- Pressure setback (Enable or Disable, Enable)
- Pressure setback setpoint (80, 100, 85) % of System discharge pressure setpoint
- Pressure setback control mode (Linear or Quadratic, Quadratic)
- BAS Interface setup: Protocol(Modbus or Lonworks or Bacnet MSTP or BACnet IP or none, none), Node (1 to 128, 1), Baud(9600 to 115200, 19200)
- FieldBus setup: Source(Fbus2, Fieldbus card, Fbus2)
- Pump model (Current pump model).
- Design flow (number).It is the (Maximum) Design flow of the booster system.
- Design flow unit ((US GPM, UK GPM, m<sup>3</sup>/hour, l/sec), US GPM).
- (Display) Flow units ((US GPM, UK GPM, m<sup>3</sup>/hour, l/sec), US GPM) - Not Important, setup by a customer.
- Flow offset (0.75, 1.2, 1.0) adjust the calculated flow to the measured flow.

When changing the system discharge setpoint press the **Update limits yes** button to automatically update the High and Low pressure limits for the discharge and suction pressure.

**RUNNING:**

**DONE**

- Check and make sure all pumps are in the **auto** position (on PLC and VFD)
- Turn all the isolating valves to the fully open position
- Put the Remote/Local switch in Local position and the booster system will run.  
If start/stop of the booster is control by the remote BAS dry contact switch put the Remote/Local switch in Remote position and close BAS remote switch.
- In initial run check for noise, vibration, etc., and any leaks in the pipework.
- Pumps should continue to maintain set point

**NO FLOW SHUTDOWN (NFS) TEST:**

**DONE**

- Check and make sure all pumps are in the **auto** position (on PLC and VFD)
- When system is running, isolate booster system from building loop (run it against a deadhead)
- Pumps should continue to maintain set point while ramping down and eventually shutting down to one pump only
- The single pump after 300s (default) will ramp up to your NFS Pressure Boost setpoint and then shut down

**SIGNOFF:**

By signing off on this startup checklist, both parties hereby accept that the equipment listed in this checklist has been properly verified to be fully operational and functioning as per the sales order for the equipment listed.

Startup Technician Name (Please print):

Customer Name (Please print):

\_\_\_\_\_  
Startup Technician Signature:

\_\_\_\_\_  
Customer Signature:

\_\_\_\_\_  
Date (mm/dd/yyyy):

/ /

\_\_\_\_\_  
Date (mm/dd/yyyy):

/ /

## 1.0 INSTALLATION INSTRUCTIONS

**Incoming supply – ivs system on rack** – The incoming power supply to the ivs Controller is achieved through a transformer in the main enclosure of the whole ivs System rack. No power connection is required.

**Note:** All electrical wiring should be performed by a qualified electrician in accordance with the latest edition of the National Electrical Code, local codes and regulations.

### FIELD DEVICES INSTALLATION INSTRUCTIONS

Before attempting to start configuring the IVS Controller using the Operator Interface (HMI – touch-screen), make sure all the field installed devices such as pressure sensors, level switch(es), etc. are properly installed and wired to the ivs Controller as per the wiring diagram.

**Note:** Please fill in the ivs Pre-Commissioning Check List (below) which will help you through the set-up procedure of the IVS Controller. The main information required would be the number of pumps, pressure sensors range, pressure setpoint, high and low limits of pressure, soft fill mode, no flow shut down, pressure setback and emergency power mode.

### BUILDING AUTOMATION SYSTEM (BAS) CONNECTION

The ivs Controller is provided with an RS 485 serial port to communicate serially to the BAS. The standard communication protocol is Modbus; BACnet and Lonworks are options. Refer to the wiring diagram for wiring instructions. Please refer to the ivs Controller generic terminal block drawing for the different parameters and data points communicated to the BAS.

### SCREENS OVERVIEW

The ivs integrated controller HMI is divided in three set of screens: Operation, Setup, and Alarm.

The Operation Screens are used by the users to view and control the Pumps. The Setup Screens are used to set, view, save, and restore the system specific settings (i.e. pressure set point and limits, soft fill mode, pumps parameters, etc.). The Alarm screens are used to display the current alarms, store and display history alarms, give helpful information on each alarm.

The list of screens in each set is as follow:

#### Operation screens:

- Main menu
- System overview
- Pump overview

- Pump 1 control
- Pump 2 control
- Pump 3 control
- Pump 4 control
- Pump 5 control
- Login
- Service overview

The System Screens can be accessed without any password

#### Alarm screens:

- Alarm
- Alarm and Help
- Alarm history

The Alarm screens can be accessed and operated (such as pressing a 'reset' button) without any password.

#### Setup screens:

The Setup Screens are divided in three levels. All the three levels have the same number of screens with different level of access. Level 0 setup screens are for viewing only and no adjustment can be made. Level 1 setup screens can be used for changing the system setup, restoring the system factory defaults except for the PID parameters in the PID Setup Screens. Level 2 setup screens can be used for changing the system setup, and saving and restoring the system factory defaults. To access Level 1 and level 2 Setup Screens an operator need to enter the proper password. Level 2 password is for factory setup.

The list of Setup Screens for every level is as follow:

- Setup menu
- Booster setup
- Sensor setup
- Speed setup
- Staging setup
- Pressure setup
- Pressure limit setup
- Soft fill setup
- No flow shutdown setup
- PID setup
- Pressure setback setup
- Protection setup
- BAS setup
- Fieldbus setup
- Clock setup

The Level 1 Setup Screens also have a set of 'Restore Default Settings' to restore the default setup values on each screen. The Level 2 Setup Screens have a set of 'Restore Default Settings' and 'Save Default Settings' to restore or save the default values on each screen.

**SYSTEM FUNCTIONS**

The System functions of the HMI operator interface include the Operator Screens, the Installer Screens, and the Factory Screens. To access the Installer Screens, the user is required a level 1 password. To access the Factory Screens, the user is required a level 2 password. There is no password requirement to access the Operator Screens.

**OPERATOR SCREENS**

Operator Screens include operation screens, alarm management screens and level 0 setup screens. These screens can be accessed without any password, and level 0 setup screens are for viewing only.

**1.1 OPERATION SCREENS**

See the following table

**1.1.0 MAIN MENU**

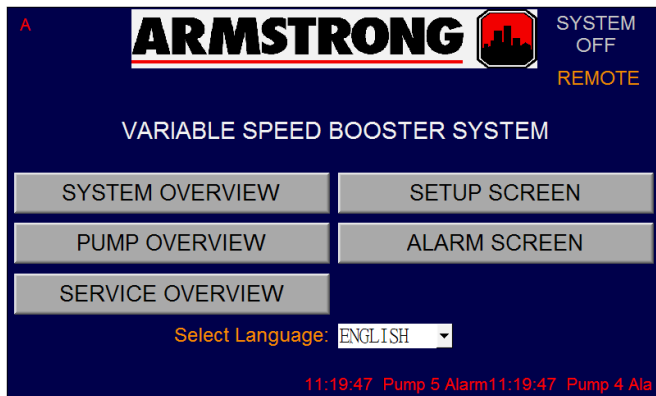

This is the screen the operator sees when powering up the unit.

- 1 Press **System overview** to view the layout of the system, system pressure setpoint, discharge pressure, remote pressure, suction pressure and boost pressure, pumps speed and status.
- 2 Press **Pump overview** to view pumps status, speed, run time and alarm.
- 3 Press **Alarm screen** to view any alarm condition that might have occurred.

- 4 Press **Setup screen** for pump, sensor, pressure, limit and soft fill setup (password protected).
- 5 Press **Service overview** to view pumps status, vfd status, communication, faults and alarms.
- 6 Press the drop-down list beside **Select Language** to select other display language for all the screens.
- 7 Any alarm occurred in the system will be displayed in scroll bar in the bottom area.

**1.1.1 SYSTEM OVERVIEW**

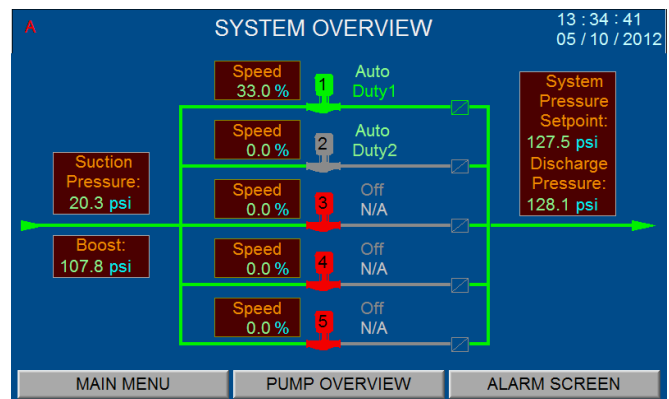

- 1 The active System pressure setpoint is displayed.
- 2 Discharge and suction pressure are displayed.
- 3 Remote pressure is displayed if the remote sensor is enabled in **sensor setup** screen.
- 4 Boost pressure is displayed.
- 5 Pumps' running status, alarm status, Auto/On/Off/Hand status, duty/standby order and speed are displayed.
- 6 Pressing the pump icons will change the current screen to the pump control screen.
- 7 Press the buttons on the menu at the bottom to bring up the desired screen.

**1.1.2 PUMP OVERVIEW**

	PUMP 1	PUMP 2	PUMP 3	PUMP 4	PUMP 5
Mode	Auto	Auto	Off	Off	Off
Duty	Duty1	Duty2	N/A	N/A	N/A
Run	Running	Stopped	Stopped	Stopped	Stopped
Speed	33.0 % 587 RPM	0.0 % 0 RPM	0.0 % 0 RPM	0.0 % 0 RPM	0.0 % 0 RPM
RunHrs	0003	0000	0000	0000	0000
Alarm	Ok	Ok	Alarm	Alarm	Alarm

System Pressure: 128.1 psi      Lead Switch in: 20 Days

- 1 **Mode** shows pump operation mode: Hand, Off, or Auto.
- 2 **Duty** shows which pump is duty and which one is standby.
- 3 **Run** shows whether the pump is running or stopped
- 4 Speed is displayed in both % value of full speed and absolute RPM.
- 5 Run Hours are displayed and can be reset in the pump control screen.
- 6 Alarm will be displayed if there is a problem with the pump.
- 7 Pressing the **Pump 1** button will bring up the **pump 1 control** screen to view and control pump parameters.
- 8 Press the buttons on the menu at the bottom to bring up the desired screen.

### 1.1.3 PUMP 1 CONTROL SCREEN



This screen is to control the pump, Hand, Off, Auto, Lead or Lag mode and hand speed

- 1 Press the **HAND, OFF, AUTO** buttons to select the desired mode.
- 2 The pump mode is displayed under these buttons, no display means **N/A**.
- 3 Press the **LEAD** button to set the pump as lead pump (the other pumps become lag).
- 4 When in **Hand** mode, enter the desired speed in the **Hand speed** box.
- 5 When in **Auto** mode, the speed of the pump is automatically determined by the PLC controller.
- 6 Pump duty is displayed: Duty1(Lead), Duty2(Lag), Duty3(Lag), Duty4(Lag), Duty5(Lag) or Standby.
- 7 Pump status is displayed (Running or Stopped).
- 8 Run Hours indicates the pump total running time since the last reset and can be reset by pressing the displaying area.
- 9 Drive fault will be displayed if there is a problem with the vfd.
- 10 Alarm will be displayed if there is a problem with the pump.
- 11 Controller output speed (Reference speed sent to the vfd) is displayed in % value of pump full speed
- 12 Pump actual speed (Feedback from the vfd) is displayed in % value of pump full speed and RPM.
- 13 VFD amps, voltage and power are displayed.
- 14 Press the buttons on the menu at the bottom to bring up the desired screen.

### 1.1.4 LOGIN SCREEN



1. In order to be able to modify any of the Setup parameters you must Login with the proper password.
- 2 There are 3 levels of setup screens. Level 1 and level 2 require operator to input password. Level 0 will allow viewing the setup values only. Level 1 will allow changes to setup values and to restore the system factory defaults except for the PID parameters. Level 2 will allow changes to all the setup values, and to save or restore all the system factory defaults. All the three levels will allow controlling the pumps.
- 3 From the **Main menu** screen, pressing the **Setup screen** button will call up this screen.
- 4 Pressing the password area to the right of **Log In:** will pop-up this keypad. Inputting the password through the keypad, then pressing the **Ent** button in the keypad will return to this screen or go to the screen corresponding to the password.

### 1.1.5 SERVICE OVERVIEW SCREEN

SERVICE OVERVIEW									
Drive	Speed%	Amp	VAC	kW	Run	Drive Fault	Status	Ramp	
1	100.0	0.0	0.0	0.0	Running	OK	Hand	Stop	
2	74.3	0.0	0.0	0.0	Running	OK	Hand	Stop	
3	0.0	0.0	0.0	0.0	Stopped	OK	Hand	Stop	
4	0.0	0.0	0.0	0.0	Stopped	OK	Hand	Stop	
5	0.0	0.0	0.0	0.0	Stopped	OK	Hand	Stop	
Drive	Duty	Mode	Modbus fault			Suction Pressure:	Discharge Pressure:		
1	Duty1	Auto	Timeout	OK	20.3 psi	80.0 psi			
2	Duty2	Auto	Timeout	OK					
3	N/A	Off	OK	OK					
4	N/A	Off	OK	OK					
5	N/A	Off	OK	OK					
Boost: 59.7 psi									
SERVICE CONTACT									
MAIN MENU			SYSTEM OVERVIEW			COMMISSION			

- 1 Drive means VFD.
- 2 Speed% is the actual motor speed (0-100.0%).
- 3 Amp is the actual pump motor current.
- 4 VAC is the actual pump motor voltage.
- 5 kW is the actual pump motor power.
- 6 Run shows whether the pump motor is running or stopped.
- 7 Drive Fault is the fault status of the vfd and can either be ok or Fault.
- 8 Status is the current auto status of the vfd and can either be Auto or Hand.
- 9 Ramp is the current ramp status of the vfd and can either be Stop or Ramp.
- 10 Pump duty is displayed: Duty1(Lead), Duty2(Lag), Duty3(Lag), Duty4(Lag), Duty5(Lag) or Standby
- 11 Mode is either Hand, Off, or Auto.
- 12 The first part of Modbus fault information is the current Modbus communication status between PLC and vfd. It can either be: Invalid Request / Timeout / ok / Illegal Faction / Illegal Address / Illegal Value / Slave Failure / Acknowledge / Slave Busy.
- 13 The second part of Modbus fault information is the current Modbus communication alarm status of the vfd and can be ok or Fault.
- 14 The Suction Pressure is displayed.
- 15 The Boost Pressure is displayed.
- 16 The active System pressure is displayed.
- 17 The (Local) Discharge Pressure is displayed.
- 18 The Remote Discharge Pressure is displayed if the remote sensor is enabled.

### 1.1.6 COMMISSION SCREEN

COMMISSION	
Disable	
1) No Flow shutdown:	
2) Pressure setback mode:	
Active for 24 hours.	Commission mode off
SERVICE OVERVIEW    MAIN MENU    SYSTEM OVERVIEW	

- 1 Where if Commission mode off/on switch is in Commission mode on position it disables the no flow shutdown and the pressure setback mode. The commission mode is active for only 24 hours. The commission mode is used for testing an ivs Booster system in case of not occupy building with no flow in it.

### 1.1.7 SERVICE CONTACT SCREEN

SERVICE CONTACT	
Local Service Support Provided By:	
ENTER SERVICE COMPANY NAME	
ENTER 1-555-123-4567	
ENTER WWW.EXAMPLE.COM	
ENTER SERVICE@EXAMPLE.COM	
For Armstrong Factory Support:	
1-844-238-2377	
www.armstrongfluidtechnology.com	
aftersaleservice@armstrongfluidtechnology.com	
SERVICE OVERVIEW    MAIN MENU    SYSTEM OVERVIEW	

- 1 The service contact screen displays the Armstrong factory support information as well as the local service support information.
- 2 A local service provider should enter his contact information in four available lines.

## 1.2 ALARM MANAGEMENT SCREENS

See the following table

### 1.2.1 ALARMS SCREEN

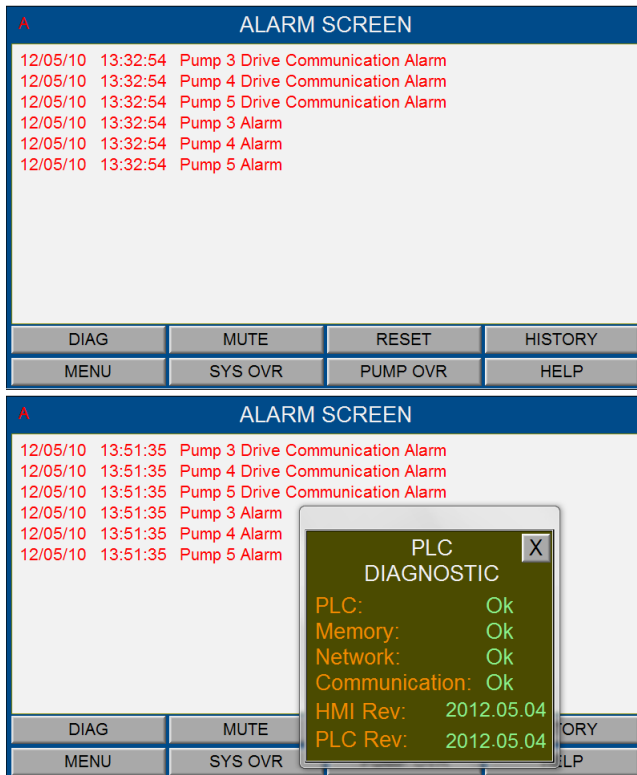

- 1 All alarms will be displayed in chronological order.
- 2 The last alarm will be at the top of the screen.
- 3 Press **DIAG** to pop up the PLC DIAGNOSTIC box.
- 4 Press **Reset** to reset all active alarms.
- 5 Press the **Mute** button to silence the alarm Horn and stop the flashing of alarm light.
- 6 Press the up and down arrow buttons to view more alarms.
- 7 Press the left and right arrow buttons to view more content of the alarms.
- 8 Press the **Help** button to bring up the Alarm and Help screen.
- 9 Press the **History** button to bring up the Alarm History screen.
- 10 Press the buttons on the menu at the bottom to bring up the desired screen.

### 1.2.2 ALARM & HELP SCREEN

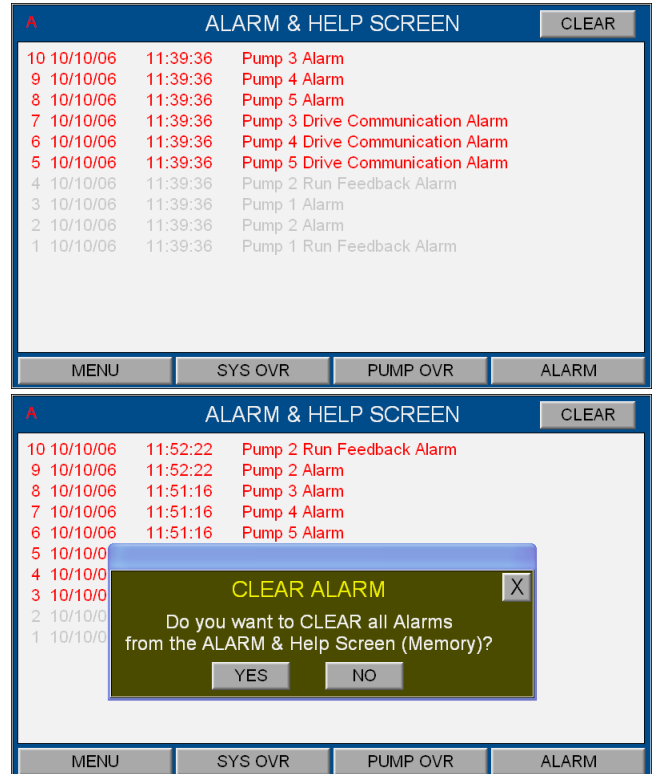

- 1 The alarms saved in the internal memory of the HMI are displayed.
- 2 Pressing the alarm displayed will bring up the alarm Information screen.
- 3 Press the **Clear** button will pop up **Clear alarm** box. The alarms in the internal memory of the HMI can be cleared by press **YES** button in this box.
- 4 Press the up and down arrow buttons to view more alarms.
- 5 Press the left and right arrow buttons to view more content of alarms.
- 6 Press the buttons on the menu at the bottom to bring up the desired screen.

1.2.3 ALARM INFORMATION SCREEN

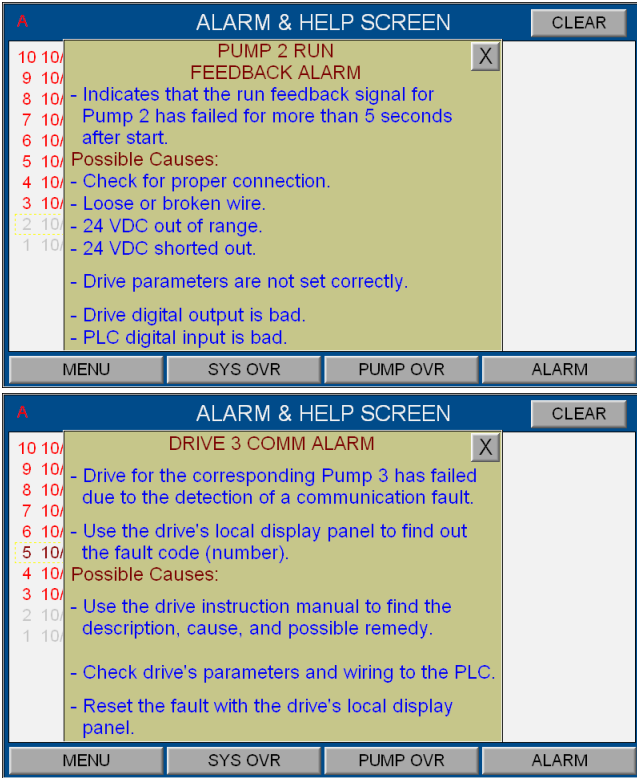

- 1 Press any alarm in Alarm & Help screen will pop up a corresponding alarm information box.
- 2 The alarm description, the possible cause of alarm and the remedy for this alarm will be displayed in the alarm information box.
- 3 Press the upper right cross button to close this box.

1.2.4 ALARM HISTORY SCREEN

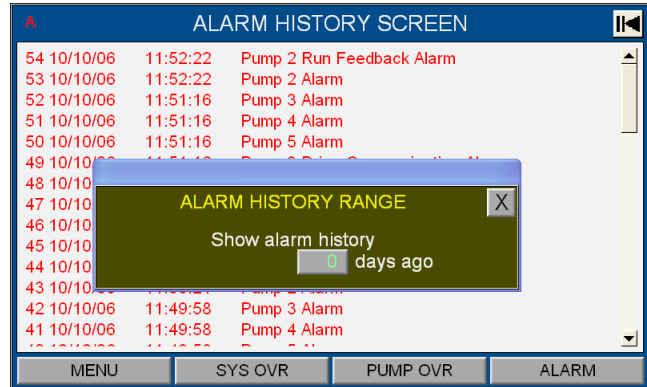
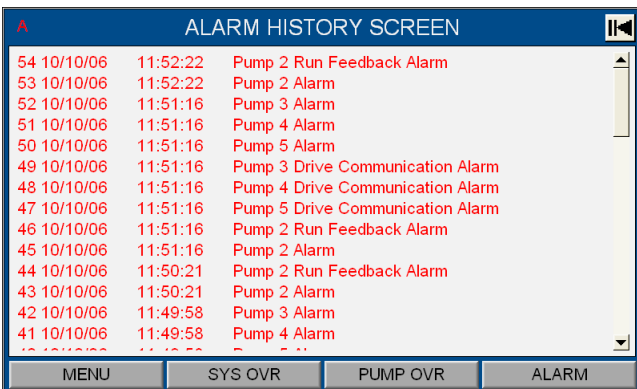

- 1 The history alarms saved in the internal memory of the HMI are displayed.
- 2 Press the top-right button (black arrow) to select the history alarm to display. The selected number indicates the number of days before today. The history alarms will be displayed for that day.
- 3 Press the up and down arrow buttons to view more alarms.
- 4 Press the left and right arrow buttons to view more content of alarms.
- 5 Press the buttons on the menu at the bottom to bring up the desired screen.

1.3 LEVEL 0 SETUP SCREENS

See the following table

1.3.0 LEVEL 0 SETUP MENU

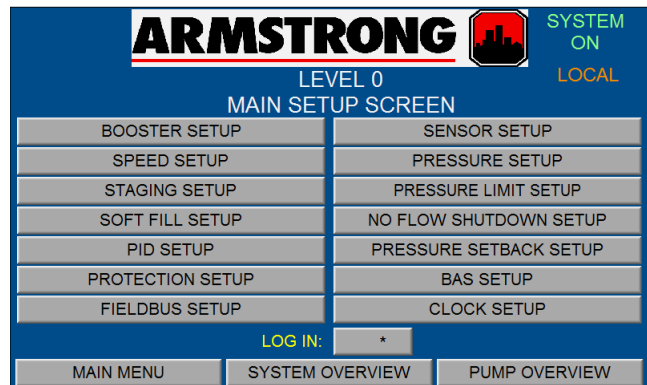

- 1 Touching the **Setup** screen button from **Main menu** will call up the Level 0 Setup screen.
- 2 Pressing the password area to the right of **Log In:** will pop-up a keypad to log on to installer screens or factory screens.
- 3 The top left corner of the screen will flash **A** when there is a new alarm. The **A** will be solid when the alarm is acknowledged or muted. Pressing the **A** will call up the alarm screen.
- 4 Pressing any of the **SETUP** button will call up its corresponding Setup display.



- 5 These screens are for viewing only. No values can be modified on these screens.
- 6 Below are the screens that the user sees when pressing on each of those buttons.
- 7 Touch the buttons on the menu at the bottom to bring up the desired screen.
- 8 Touching the **Right** and **Left** arrow will navigate between the viewing only Setup Screens.

### 1.3.1 BOOSTER SETUP

**BOOSTER SETUP**

- 1) Number of Pumps: 2 Pumps
- 2) Standby Pump: No Standby Pump
- 3) Level Switch 1: Disable
- 4) Level Switch 2: Disable
- 5) Drive Type: Danfoss FC 102
- 6) Drive Frequency: 60 Hz
- 7) Enter Lead Pump Switch Time: 24 Hours
- 8) Enter Pump Rated Power: 10.0 kW

\* FOR VIEWING ONLY.

MAIN MENU SYSTEM OVERVIEW MAIN SETUP

### 1.3.2 SENSOR SETUP

**SENSOR SETUP**

	Zero	Range	Units	Enable
1) Suction pressure:	0.0 ~	300.00	psi	Yes
2) Discharge pressure:	0.0 ~	300.00	psi	Yes
3) Remote discharge pressure:	0.0 ~	300.00	psi	No

\* FOR VIEWING ONLY.

MAIN MENU SYSTEM OVERVIEW MAIN SETUP

### 1.3.3 SPEED SETUP

**SPEED SETUP**

- 1) Pump minimum speed: 40.0 %
- 2) Pump maximum speed: 100.0 %
- 3) Pump default speed when all discharge pressure sensors fail: 70.0 %
- 4) Rated RPM from motor nameplate: 3540 RPM
- 5) Speed maximum ramp time: 15 Sec

\* FOR VIEWING ONLY.

MAIN MENU SYSTEM OVERVIEW MAIN SETUP

### 1.3.4 PRESSURE SETUP

If a Remote Discharge Sensor is enabled.

**PRESSURE SETUP**

- 1) (Local) discharge pressure setpoint: 150.00 psi
- 2) Remote discharge pressure setpoint: 130.00 psi
- 3) Choose the control sensor: Local
- 4) Auto set pressure limits: Auto Set

\* FOR VIEWING ONLY.

ALTERNATE DISCHARGE PRESSURE SETUP MENU

MAIN MENU SYSTEM OVERVIEW MAIN SETUP

If a Remote Discharge Sensor is disabled.

**PRESSURE SETUP**

- 1) System discharge pressure setpoint: 150.00 psi
- 2) Auto set pressure limits: Auto Set

\* FOR VIEWING ONLY.

ALTERNATE DISCHARGE PRESSURE SETUP MENU

- 1) Number of Setpoints (0-6): 0
- 2) System discharge pressure setpoint 1: 91.00 psi
- 3) System discharge pressure setpoint 2: 92.00 psi
- 4) System discharge pressure setpoint 3: 93.00 psi
- 5) System discharge pressure setpoint 4: 94.00 psi
- 6) System discharge pressure setpoint 5: 95.00 psi
- 7) System discharge pressure setpoint 6: 96.00 psi

\* FOR VIEWING ONLY.

PRESSURE SETUP

MAIN MENU SYSTEM OVERVIEW MAIN SETUP

### 1.3.5 STAGING SETUP

**STAGING SETUP**

1) Pump stage on speed:  %

2) Pump stage off by:

3) Pump stage off speed:  %

4) Pump stage off power:  %

5) Pump stage on delay:  Sec

6) Pump stage off delay:  Sec

\* FOR VIEWING ONLY.

### 1.3.8 NO FLOW SHUTDOWN SETUP

**NO FLOW SHUTDOWN SETUP**

1) No Flow shutdown:

2) No Flow shutdown delay:  Sec

3) Lead pump No Flow shutdown setpoint:   %

4) No Flow shutdown wait time:  Sec

5) No Flow boost pressure:  psi

\* FOR VIEWING ONLY.

### 1.3.6 PRESSURE LIMIT SETUP

**PRESSURE LIMIT SETUP**

1) High suction pressure shutdown limit:  psi

2) High discharge pressure alarm/shutdown limit:  psi

3) Low suction pressure alarm/shutdown limit:  psi

4) Low discharge pressure alarm/shutdown limit in normal mode:  psi

5) Low discharge pressure alarm limit in emergency power mode:  psi

6) Number of Pumps in emergency power mode:

7) Factory high discharge alarm/shutdown pressure:  psi

\* FOR VIEWING ONLY.

### 1.3.9 PID SETUP

**PID SETUP**

1) Gain:  %/sec

2) Speed Up Limit:  %/sec

3) Speed Down Limit:  %/sec

\* FOR VIEWING ONLY.

### 1.3.7 SOFT FILL SETUP

**SOFT FILL SETUP**

1) Soft Fill mode:

2) Soft Fill setpoint percent:  %

3) Soft Fill Ramp Time:  Sec

\* FOR VIEWING ONLY.

### 1.3.10 PRESSURE SETBACK SETUP

**PRESSURE SETBACK SETUP**

1) Pressure setback mode:

2) Pressure setback setpoint:  %

3) Pressure setback control mode:

\* FOR VIEWING ONLY.

### 1.3.11 PROTECTION SETUP

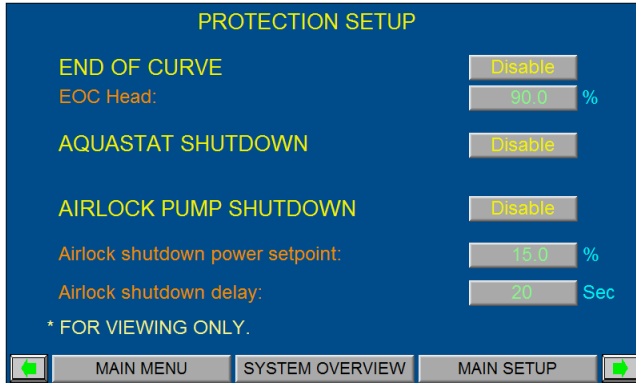

### 1.3.12 BAS SETUP

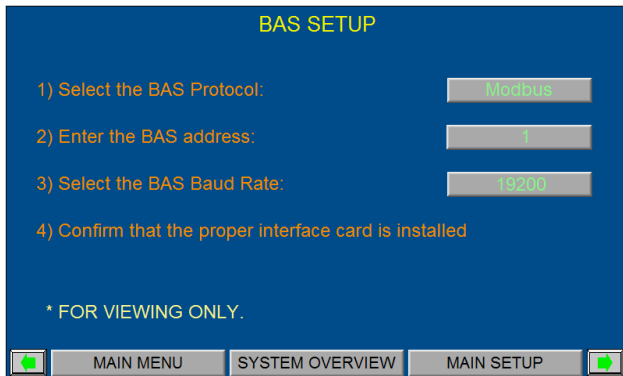

### 1.3.13 FIELDBUS SETUP

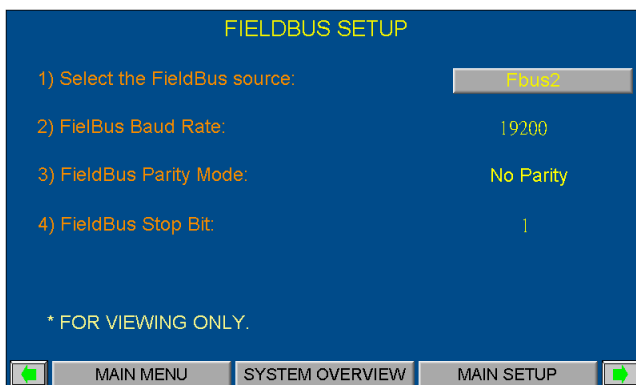

### 1.3.14 CLOCK SETUP

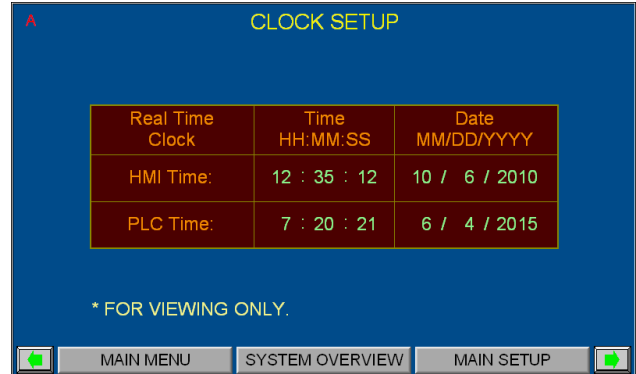

## 2.0 INSTALLER SCREENS

Installer screens include operation screens, alarm management screens, and level 1 setup screens. To access level 1 setup screens the user is required a level 1 password.

### 2.1 OPERATION SCREENS

See previously in the Operator Screens, **SECTION 1.1.**

### 2.2 ALARM MANAGEMENT SCREENS

See previously in the Operator Screens, **SECTION 1.2.**

### 2.3 LEVEL 1 SETUP SCREENS

Most of the level 1 setup screens are almost the same as the level 0 setup screens, except that the user can touch buttons and input areas to change the parameter, press **Restore** button to restore changed values to the system factory defaults on each setup display screen.

#### 2.3.0 LEVEL 1 SETUP MENU

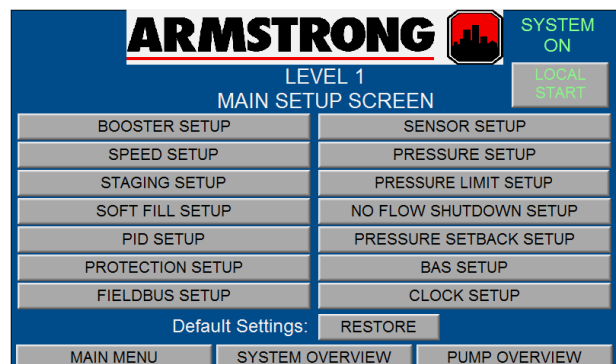

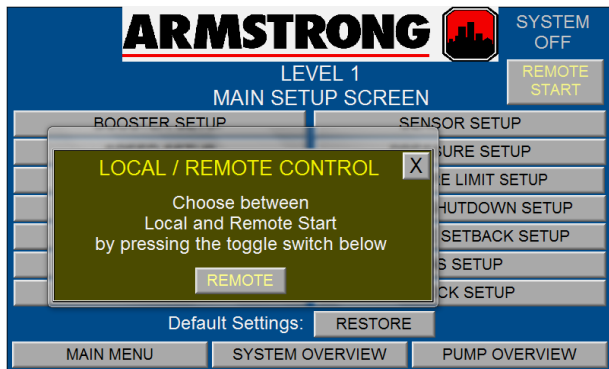

- 1 Pressing and inputting the proper password in **Level 0 setup** screen will call up the Level 1 Setup screen.
- 2 Pressing the **Local/remote start** button will pop-up a box to switch IVS between **Local** and **Remote** status (next picture). Under local status the IVS booster will be started immediately. Under remote status the IVS booster will be stopped, or started by the BAS or the customer's hardwire contact.
- 3 The top left corner of the screen will flash **A** when there is a new alarm. The **A** will be solid when the alarm is acknowledged or muted. Pressing the **A** will call up the alarm screen.
- 4 Pressing any of the **Setup** button will call up its corresponding Setup screen. These screens are for changing the system setup and restoring the system factory defaults.
- 5 PID setup screens are for viewing only.
- 6 After changing values in any setup screens, should you want to go back to the factory default values, press the **Restore** button.
- 7 Below are the screens that the user sees when pressing on each of those buttons.
- 8 Touch the buttons on the menu at the bottom to bring up the desired screen.
- 9 Touching the **Right** and **Left** arrow will navigate between the Level 1 Setup Screens.

### 2.3.1 BOOSTER SETUP

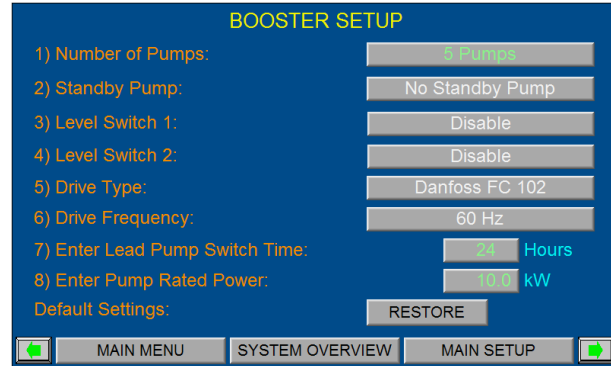

- 1 Press **Booster setup** button from **Level 1 main setup** to bring up this screen.
- 2 Touching the bar button beside the description of **number of pumps** will toggle between **0 pump, 1 pump, 2 pumps, 3 pumps, 4 pumps** and **5 pumps**.
- 3 Touching the bar button beside the description of **Standby pump** will toggle between **No standby pump** and **One standby pump**.
- 4 Touching the bar button beside the description of **Level Switch 1** will toggle between **Enable** and **Disable**.
- 5 Touching the bar button beside the description of **Level Switch 2** will toggle between **Enable** and **Disable**.
- 6 Touching the bar button beside the description of **Drive type** will toggle between **Danfoss FC 102** and **Danfoss FCM 300**.
- 7 Touching the bar button beside the description of **Drive frequency** will toggle between **60Hz** and **50Hz**.
- 8 Enter the lead pump switch time. After the duty 1 pump runs for the entered amount of hours, the duty 2 or standby pump will switch to lead.
- 9 Enter the pump rated power as indicated on the motor nameplate.
- 10 Press the **Restore** button to retrieve booster setup values from the system factory defaults.
- 11 Touch the buttons on the menu at the bottom to bring up the desired screen.

### 2.3.2 SPEED SETUP

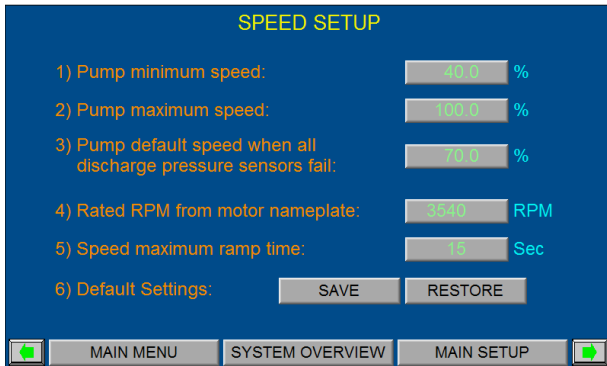

- 1 From **Level 1 main setup** press on **Speed setup** to call up this screen.
- 2 Enter the minimum speed the pump will be allowed to run in Auto or Hand mode.
- 3 Enter the maximum speed the pump will be allowed to run in Auto or Hand mode.
- 4 Enter the pump default speed. If discharge pressure sensor and remote pressure sensor fail, the running pump in Auto mode will have its speed set to the default speed.
- 5 Enter the pump rated RPM as indicated on the motor.
- 6 Enter the speed maximum ramp time. The ramp time in the PLC and the drives should always be 15 sec. That allows the actual ramp up time to be controlled by the PID Speed Up and Speed Down Limits. The ramp time is amount of time it will take the pumps to increase the speed from 0% to 100% or to decrease the speed from 100% to 0%.
- 7 Press the **Restore** button to retrieve speed setup values from the system factory defaults.
- 8 Touch the buttons on the menu at the bottom to bring up the desired screen.

### 2.3.3 SENSOR SETUP

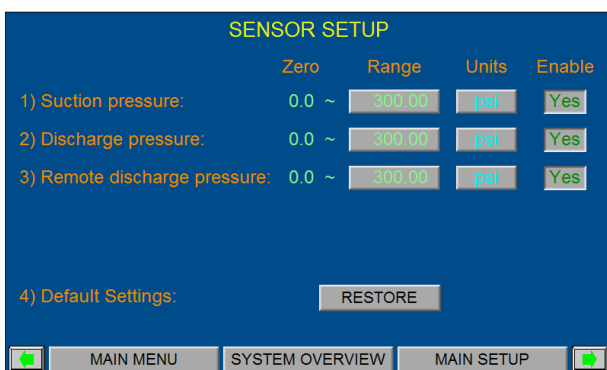

- 1 From **Level 1 main setup** press on **Sensor setup** to call up this screen.

- 2 Press the first box in column 1 to enter the range for the system suction pressure sensor.
- 3 Press the second box in column 1 to enter the range for system discharge pressure sensor.
- 4 Press the third box in column 1 to enter the range for system remote pressure sensor.
- 5 Press any box in column 2 to toggle the pressure unit among **psi, ft, KPa, m** and **bar**.
- 6 Press the first box in column 3 to enable or disable the system suction pressure sensor.
- 7 Press the second box in column 3 to enable or disable the system discharge pressure sensor.
- 8 Press the third box in column 3 to enable or disable system remote pressure sensor.
- 9 Press **Restore** button to retrieve sensor setup values from the system factory defaults.
- 10 Touch the buttons on the menu at the bottom to bring up the desired screen.

### 2.3.4 PRESSURE SETUP

If a remote discharge sensor is enabled.

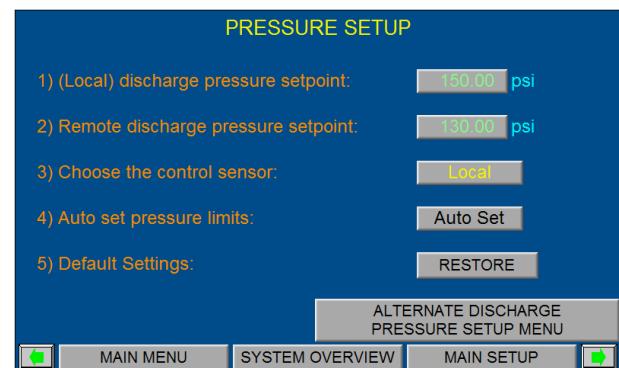

If a remote discharge sensor is disabled.

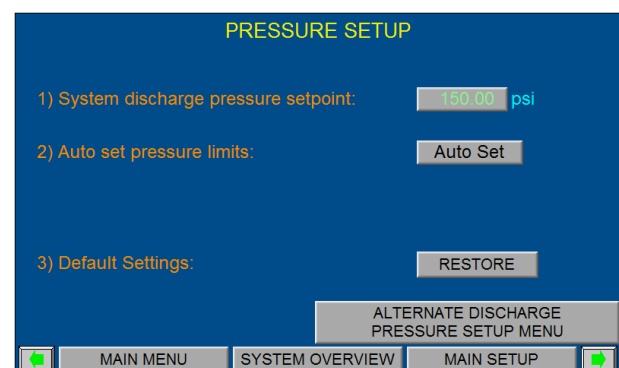

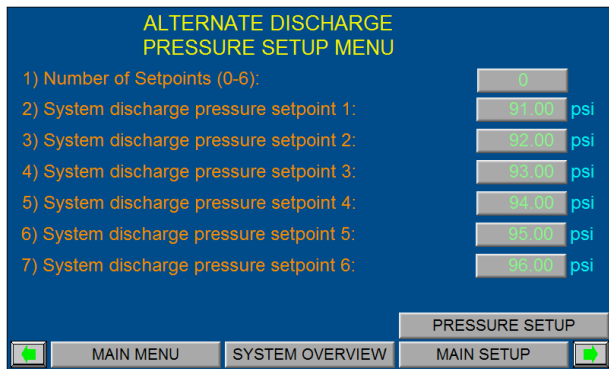

- 1 Touch the **Pressure setup** button from **Level 1 main setup** screen to call up this screen.
- 2 The **Pressure setup** has different screens. With the remote pressure sensor enabled, the first screen will be displayed. With the remote pressure sensor disabled, the second screen will be displayed.
- 3 Enter the discharge pressure setpoint or system pressure setpoint in the white box beside the description.
- 4 Enter the remote discharge pressure setpoint in the white box beside the description.
- 5 Pressing the button beside the description of **Choose the control sensor** will toggle between **Local** and **Remote**. If **Local** is selected, the discharge pressure sensor will be the control sensor. If **Remote** is selected, the remote pressure sensor will be the control sensor.
- 6 After input the setpoints, press **Auto set** button to automatically update the High and Low pressure limits for the discharge and suction pressure according to the pressure setpoint entered.
- 7 Press the **Restore** button to retrieve pressure setup values from the system factory defaults.
- 8 Touching the **alternate discharge pressure setup menu** button to call up this screen.
- 9 Enter the Number of Setpoints.
- 10 Enter the System discharge pressure setpoint 1 in the white box beside the description. If the Number of Setpoint is greater or equal than one and the Alternate Setpoint digital input 1 is closed then the System discharge pressure setpoint 1 is used instead of Local or Remote pressure setpoint (depending on the control sensor selected). If pressure setback is enabled, it will be applied to this alternate setpoint too.
- 11 Enter the System discharge pressure setpoints from 2 to 6 in the white boxes beside the descriptions. The logic is similar as previous one.

- 12 Touch the buttons on the menu at the bottom to bring up the desired screen.

### 2.3.5 PRESSURE LIMIT SETUP

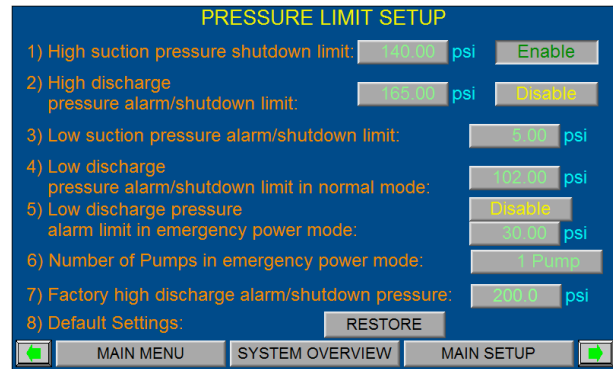

- 1 Touch the **Pressure limit setup** button from **Level 1 main setup** screen to call up this screen.
- 2 Enter high suction pressure alarm/shutdown limit by pressing the left box beside the description. By pressing the right box, this function can be enabled or disabled.
- 3 Enter high discharge pressure alarm/shutdown limit by pressing the left box beside the description. By pressing the right box, this function can be enabled or disabled.
- 4 Enter low suction pressure alarm/shutdown limit by pressing the box beside the description (Enter zero for disabling it).
- 5 Enter low discharge pressure alarm/shutdown limit in normal mode by pressing the box beside the description (Enter zero for disabling it).
- 6 Enter low discharge pressure alarm/shutdown limit in emergency power mode by pressing the box beside the description. Emergency power mode can be enabled or disabled here by pressing the box beside the description. If it's enabled, when Emergency Power occurs, the lead pump will be the pump designated to operate, auto alternation and Low Discharge Pressure Shutdown will be disabled.
- 7 Enter the Number of Pumps in Emergency power mode. Default is 1.
- 8 Factory high discharge pressure alarm/shutdown limit is displayed.
- 9 Press **Restore** button to retrieve pressure limit setup values from the system factory defaults.
- 10 Touch the buttons on the menu at the bottom to bring up the desired screen

### 2.3.6 STAGING SETUP

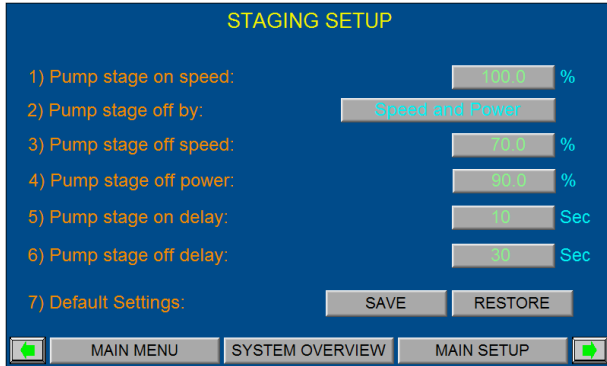

- 1 Touch the **Staging setup** button from **Level 1 main setup** screen to call up this screen.
- 2 Enter pump stage on speed for all the Lag pumps in the boxes beside the description. When the speed of lead pump reaches the corresponding speed entered above for a specific time, the next lag pump will be staged up.
- 3 Press the Pump stage off by selector box in to toggle among **Speed, Power, Speed or Power** and **Speed and Power**. Default is **Speed and Power**. If it is hard to stage off any pump change the selector to **Speed or Power** or only **Speed**.
- 4 Enter pump stage off speed for all the lag pumps beside the description.
- 5 Enter pump stage off power for all the lag pumps beside the description.
- 6 The program switches off a pump, after the Stage Off Delay time if the pumps speed is less than the Stage Off Speed and/or disconnection of one pump will cause the remaining pump(s) power to be less than the Pump(s) Stage Off Power. The speed or power condition also can be disabled. (The stage off selector settings: Speed, Power, Speed or Power, Speed and Power.)
- 7 Enter the delay time for staging on and staging off.
- 8 Press **Restore** button to retrieve staging setup values from the system factory defaults.
- 9 Touch the buttons on the menu at the bottom to bring up the desired screen.

### 2.3.7 SOFT FILL SETUP

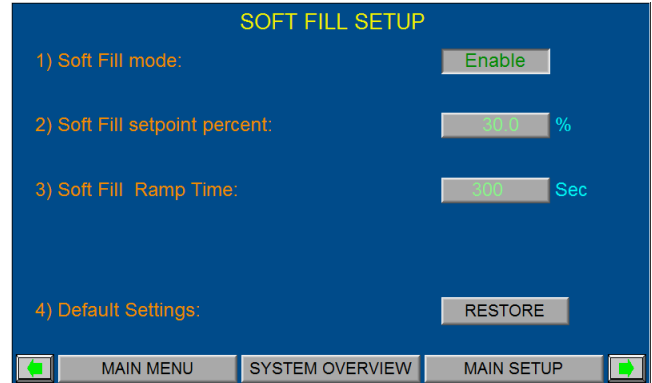

- 1 Press **Soft fill setup** button from **Level 1 main setup** to bring up this screen
- 2 Soft fill mode can be enabled or disabled by pressing the box beside the description. Soft fill happens when the booster is powered up or restarted and the discharge pressure is less than its active setpoint. The system discharge pressure setpoint increases in a linear ramp, starting at the soft fill pressure setpoint or the real discharge pressure whatever is higher at a rate of  $((\text{system discharge pressure setpoint} - \text{soft fill pressure setpoint}) / \text{soft fill ramp time})$ , until the pressure reaches the system pressure setpoint or the pressure setback setpoint (if pressure setback mode is enabled), then the booster switches to normal mode
3. Enter soft fill setpoint percent in the box beside the description. This is a percent of system discharge pressure setpoint.
4. Enter soft fill ramp time in the box beside the description.
5. Press **Restore** button to retrieve soft fill setup values from the system factory defaults.
6. Touch the buttons on the menu at the bottom to bring up the desired screen.

### 2.3.8 NO FLOW SHUTDOWN SETUP

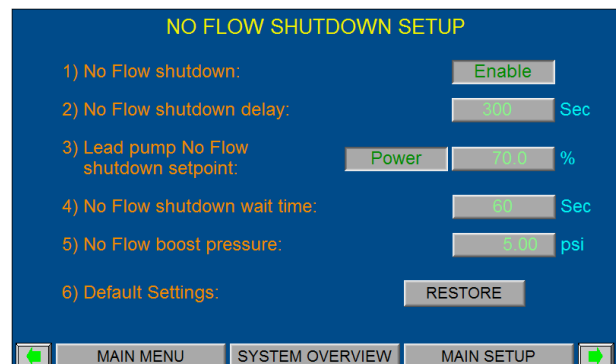

- 1 Press **No flow shutdown setup** button from **Level 1 main setup** to bring up this screen.
- 2 No flow shutdown can be enabled or disabled by pressing the box beside the description. This is feature to allow the booster to be shutdown when there is no flow demand.
- 3 Enter the no flow shutdown delay in the box beside the description. This is the delay time to check if the discharge pressure changes less than 2psi or equivalent (no flow condition) after the power/speed of lead pump is lower than **lead pump no flow shutdown power/speed setpoint**.
- 4 Enable lead pump no flow shutdown power or speed setpoint condition.
- 5 Enter lead pump no flow shutdown power/speed setpoint in the box beside the description. This is the pump power/speed when only lead pump is running to start to check the no flow condition.
- 6 Enter the no flow shutdown wait time in the box beside the description. This is the wait time to check if the discharge pressure changes less than 2psi or equivalent (no flow confirmation) after the speed of lead pump is reduced 5% when the power/speed condition of point 3 is met.
- 7 Enter no flow boost pressure in the box beside the description. This is added pressure to the pressure setpoint for 2 minutes before the booster is shutdown. After the booster is shutdown, the lead pump should be started when the discharge pressure drops 5psi or equivalent below the pressure setpoint.
- 8 Press **Restore** button to retrieve no flow shutdown setup values from the system factory defaults.
- 9 Touch the buttons on the menu at the bottom to bring up the desired screen.

### 2.3.9 PID SETUP

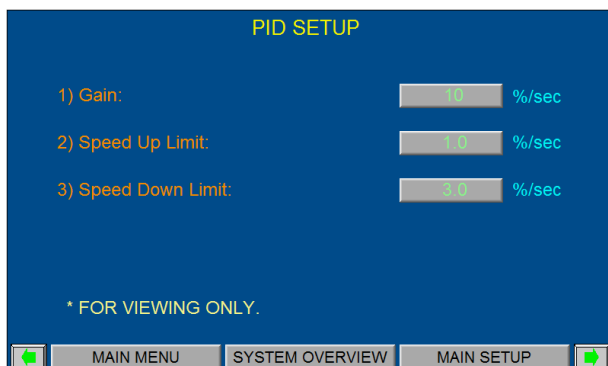

This screen is for viewing only

- 1 Press **PID setup** button from **Level 1 main setup** to bring up this screen.
- 2 Touch the buttons on the menu at the bottom to bring up the desired screen.

### 2.3.10 PRESSURE SETBACK SETUP

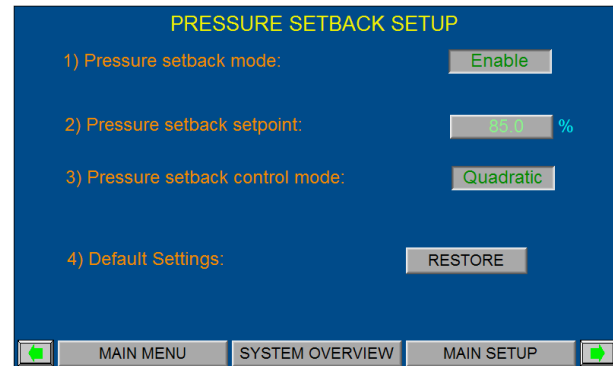

- 1 Touch the **Pressure setback setup** button from **Level 1 main setup** screen to call up this screen.
- 2 Pressure setback mode can be enabled or disabled by pressing the box beside the description
- 3 Enter the pressure setback setpoint in the box beside the description. This is a percentage of the system pressure setpoint. This feature will decrease the system pressure setpoint relative to the pumps power. When the pumps consume no power, the pressure setpoint reduces to this percent value. When all the pumps run at their rated power, the pressure setpoint is the value inputted in the pressure setup screen. The pressure setpoint will increase linearly or quadratically from this percent value to 100% when the pumps' power increase from 0 to the total rated power.
- 4 Touch the bar button beside the description of **Pressure setback control mode** to toggle between **Linear** and **Quadratic**. It enables linear/quadratic pressure control for pressure setback function.
- 5 Press **Restore** button to retrieve pressure setback setup values from the system factory defaults
- 6 Touch the buttons on the menu at the bottom to bring up the desired screen.



### 2.3.11 PROTECTION SETUP

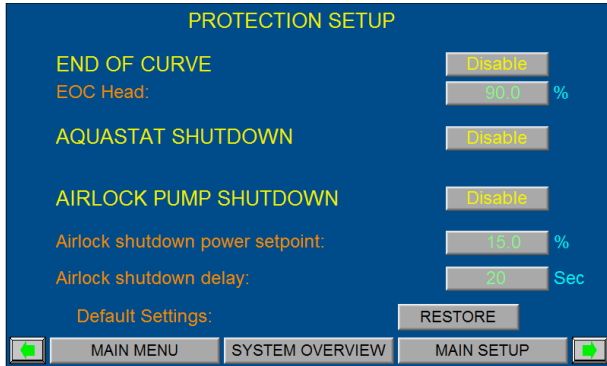

- 1 Press **Protection setup** button from **Level 1 main setup** to bring up this screen
- 2 End of Curve protection can be enabled or disabled by **pressing the box beside the description**.
- 3 Enter the End of Curve Head (Eoc head). This is the full speed Eoc head in percent of design head.
- 4 If an Aquastat switch is installed then Aquastat protection can be enabled or disabled by pressing the box beside the description. All pumps will stop running if the aquastat switch is open and the **Aquastat alarm** message will be displayed.
- 5 Airlock pump shutdown protection can be enabled or disabled by pressing the box beside the description.
- 6 Enter airlock shutdown power setpoint (percent of nominal power) in the box beside the description. When any pump speed is faster than 50% and the power it consumes is less than the Airlock power shutdown setpoint (factory set to what the pump consumes running at Minimum Speed with no flow) for longer than the Airlock shutdown delay time. The pump/drive will be tagged as 'failed'. The alarm message will indicate which pump triggered the alarm.
- 7 Enter airlock shutdown delay time in the box beside the description.
- 8 Press **Restore** button to retrieve airlock setup values from the system factory defaults.
- 9 Touch the buttons on the menu at the bottom to bring up the desired screen.

### 2.3.12 BAS SETUP

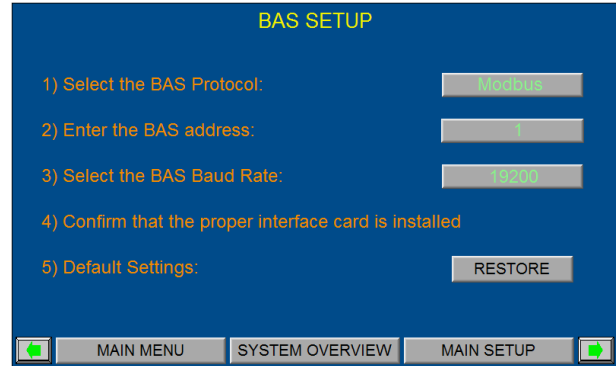

#### This screen is for viewing only

- 1 Press **BAS setup** button from **Level 1 main setup** to bring up this screen.
- 2 Touch the buttons on the menu at the bottom to bring up the desired screen.
- 3 Select the BAS Protocol (N/A, Modbus, LonWorks, Metasys, Bacnet).
- 4 Enter the BAS address.
- 5 Enter the BAS Baud Rate.
- 6 Press **Restore** button to retrieve BAS setup value from the system factory defaults.
- 7 Touch the buttons on the menu at the bottom to bring up the desired screen.

### 2.3.13 FIELDBUS SETUP

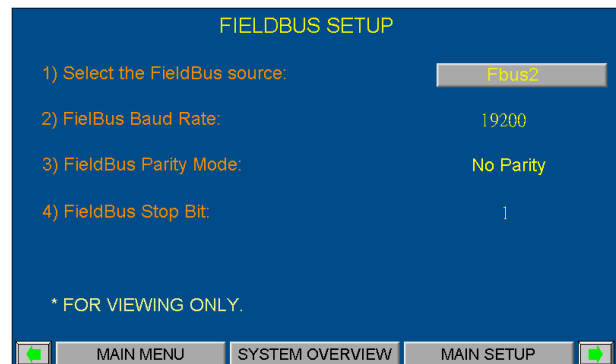

#### This screen is for viewing only

- 1 Press **Fieldbus setup** button from **Level 1 main setup** to bring up this screen.
- 2 Touch the buttons on the menu at the bottom to bring up the desired screen.

### 2.3.14 CLOCK SETUP

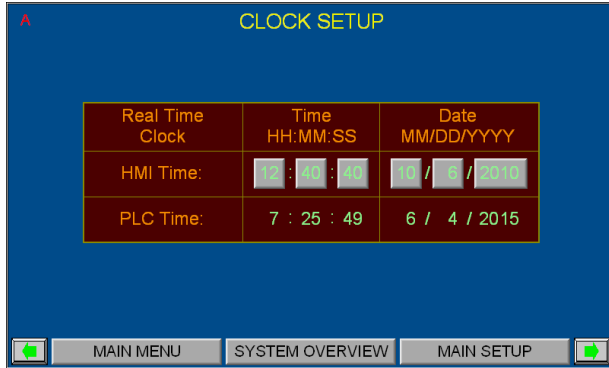

- 1 From the **Level 1 main setup** press **Clock Setup** button to call up this screen to adjust the time in the HMI and display the time in the PLC.
- 2 The HMI time and date can be adjusted by pressing the individual hour, minute, second, month, day, and year box and entering the corresponding value.
- 3 Touch the buttons on the menu at the bottom to bring up the desired screen.

## 3.0 FACTORY SCREENS

Factory Screens include operation screens, alarm management screens, and level 2 setup screens. To access level 2 setup screens a level 2 password is required.

### 3.1 OPERATION SCREENS

See above in the Operator screens, **SECTION 1.1.**

### 3.2 ALARM MANAGEMENT SCREENS

See previously in the Operator screens, **SECTION 1.2.**

### 3.3 LEVEL 2 SETUP SCREENS

Most of the level 2 setup screens are almost the same as the level 1 setup screens, except that the user can press **Save** button to save changed values to the system factory defaults on each setup display screen. However, some different screens are listed in the following table.

### 3.3.0 LEVEL 2 SETUP MENU

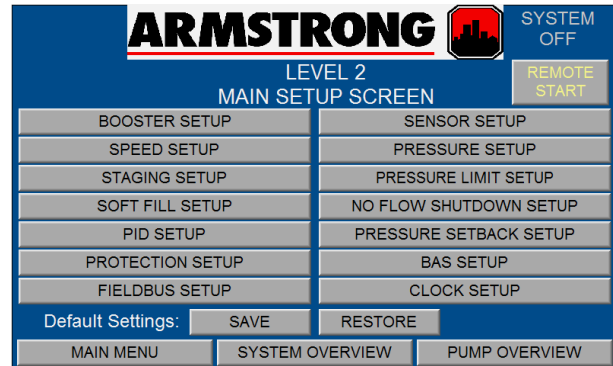

- 1 Pressing and inputting the proper password in **Level 0 setup** screen will call up the Level 2 setup screen
- 2 Pressing the **Local/remote start** button will pop-up a box to switch between **Local** and **Remote** status (next picture). Under local status the ivs booster will be started immediately. Under remote status it will be started and stopped by BAS or the customer's hardwired contact.
- 3 The top left corner of the screen will flash **A** when there is a new alarm. The **A** will be solid when the alarm is acknowledged or muted. Pressing the **A** will call up the alarm screen.
- 4 Pressing any of the **Setup** button will call up its corresponding setup screen. These screens are for changing the system setup, saving and restoring the system factory defaults
- 5 After changing values in any setup screens, press **Save** button to save all the changes as system factory defaults. Important reminder: step 5 must be executed after initial setup in order for the restore function to work properly. Otherwise restore will setup all variables to improper values!!!
- 6 After changing values in any setup screens, should you want to go back to the previously saved values, press **Restore** button.

- 7 Touch the buttons on the menu at the bottom to bring up the desired screen.
- 8 Below are the screens that the user sees when pressing on each of those buttons.
- 9 Touching the **Right** and **Left** arrow will navigate between the level 2 setup screens.

### 3.3.1 PRESSURE LIMIT SETUP

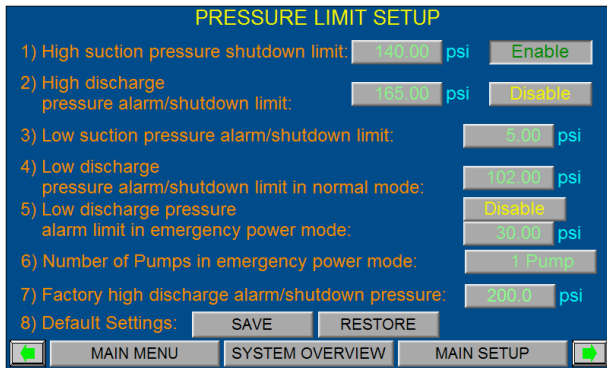

- 1 Touch the **Pressure limit setup** button from **Level 1 main setup** screen to call up this screen.
- 2 Enter high suction pressure alarm/shutdown limit by pressing the left box beside the description. By pressing the right box, this function can be enabled or disabled.
- 3 Enter high discharge pressure alarm/shutdown limit by pressing the left box beside the description. By pressing the right box, this function can be enabled or disabled.
- 4 Enter low suction pressure alarm/shutdown limit by pressing the box beside the description (enter zero for disabling it).
- 5 Enter low discharge pressure alarm/shutdown limit in normal mode by pressing the box beside the description (Enter zero for disabling it).
- 6 Enter low discharge pressure alarm/shutdown limit in emergency power mode by pressing the box beside the description. Emergency power mode can be enabled or disabled here by pressing the box beside the description. If it's enabled, when emergency power occurs, the lead pump will be the pump designated to operate, auto alternation and low discharge pressure shutdown will be disabled.
- 7 Enter the number of pumps in emergency power mode. Default is 1
- 8 Enter factory high discharge pressure alarm/shutdown limit.
- 9 Press **Restore** button to retrieve pressure limit setup values from the system factory defaults.

Touch the buttons on the menu at the bottom to bring up the desired screen.

### 3.3.2 PID SETUP

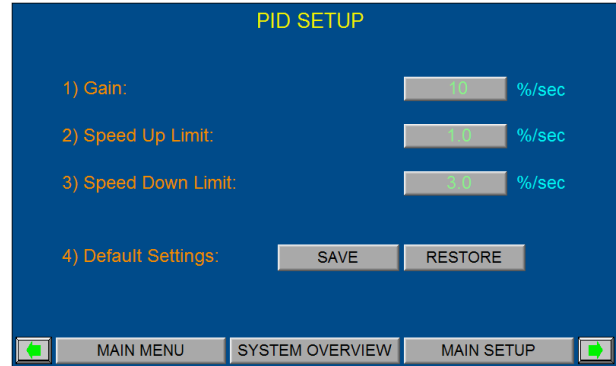

- 1 Press **pid setup** button from **Level 1 main setup** to bring up this screen.
- 2 Touch the buttons on the menu at the bottom to bring up the desired screen.
- 3 Enter the proportional gain in the box beside the description. Increasing the gain increases the reaction speed to discharge pressure changes. Decreasing the value slows down the reaction speed to a discharge pressure deviations from setpoint.
- 4 Enter the speed up limit in the box beside the description.
- 5 Enter the speed down limit in the box beside the description.
- 6 The ramp time in the PLC and the drives should always be 15sec. That allows the actual ramp up time to be controlled by the PID speed up and speed down limits. If the speed up limit = 1.0% , Max speed =100% , min speed=40% then the actual ramp up time = (max speed- min speed)/speed up limit = 60sec.
- 7 Example for PID parameters and speed relationship:  
If disch press deviation from setpoint = 15.0 PSI, gain=10%/sec and current speed=58.0%, Then Updated pumps speed= current speed + disch press deviation\* gain = 58.0% + 15.0 \* 10/100 = 58.0% + 1.5% = 59.5%  
But the pumps acceleration rate is limited by the speed up limit, so if the speed up limit = 1% then the updated speed is 58.0% + Minimum (1.0%, 1.5%) = 59.0% Instead of 59.5%.  
The pump speed update is done once per second.

### 3.3.3 FIELDBUS SETUP

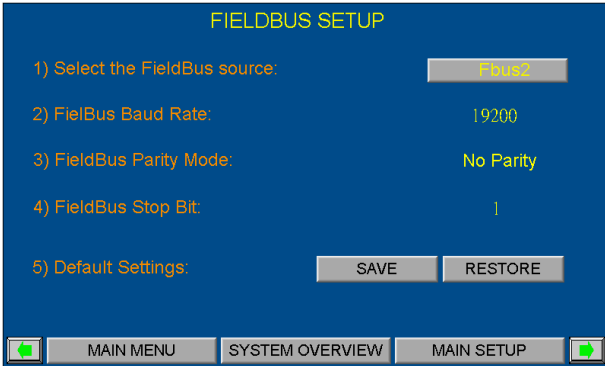

- 1 Press **Fieldbus setup** button from **Level 2 main setup** to bring up this screen.
- 2 Select the FieldBus card if the card exists. Default setting is N/A and FieldBus connection is trough built-in card FBus2.
- 3 Factory default FieldBus rate (19200), parity mode (no parity) and stop bit (1) are displayed.
- 4 Press **Save** button to save changed values to the system factory defaults, press **Restore** button to retrieve FieldBus setup value from the system factory defaults.
- 5 Touch the buttons on the menu at the bottom to bring up the desired screen.

### 3.3.4 CLOCK SETUP

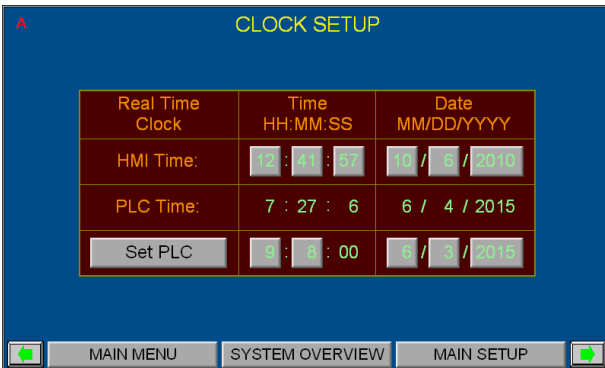

- 1 From the **Level 2 main setup** press **Clock setup** button to call up this screen to adjust the time in the HMI and the time in the PLC.
- 2 The HMI time and date can be adjusted by pressing the individual hour, minute, second, month, day, and year box and entering the corresponding value.
- 3 The system (PLC) time and date can be adjusted by pressing the individual hour, minute, month, day, and year box and entering the corresponding value.

- 4 Press **Set PLC** button to write the displayed time and date to system.
- 5 Touch the buttons on the menu at the bottom to bring up the desired screen.

## 4.0 SYSTEM START-UP PROCEDURE

- 1 Ensure the power supply to the ivs.
- 2 Turn on the main power disconnect on the door of ivs.
- 3 Touch the **Setup screen** button in the main menu screen.

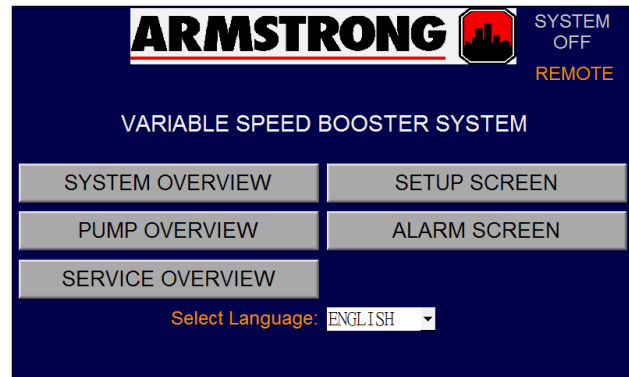

- 4 The screen changes to **Level 0 main setup screen**. Press the button beside the text of **Log In:**.

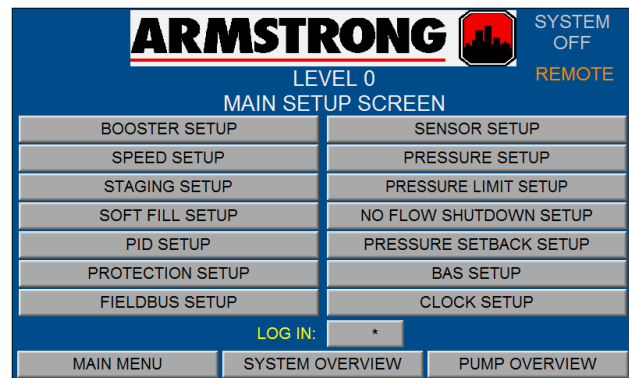

- 5 A keypad pops up. Touch the level 1 or level 2 password, then press **Ent**.

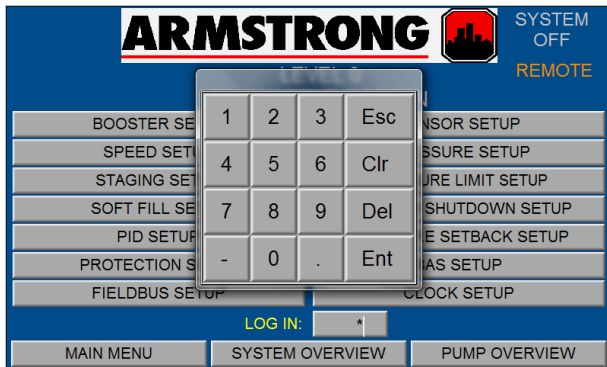

- 6 The screen changes to **Level 1 main setup screen** or **Level 2 main setup screen**. Press the button on the top-right corner indicated as **Remote start**.

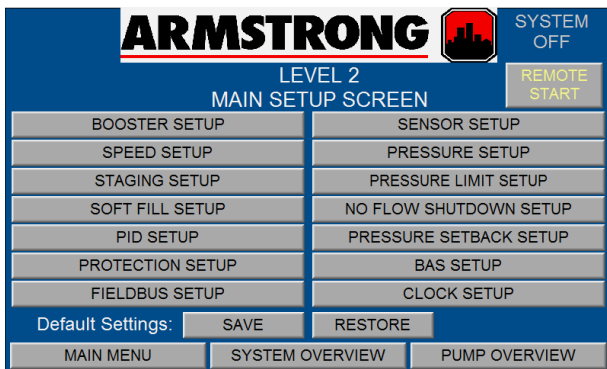

- 7 A pop-up window appears. Press the button indicated as **Remote** and the button will show as **Local**. Close the window by touching the crossing mark button.



- 8 The screen changes back to **Level 2 setup screen**. The top-right corner displays **sys ON**. Press the **Pump overview** button in the bottom.

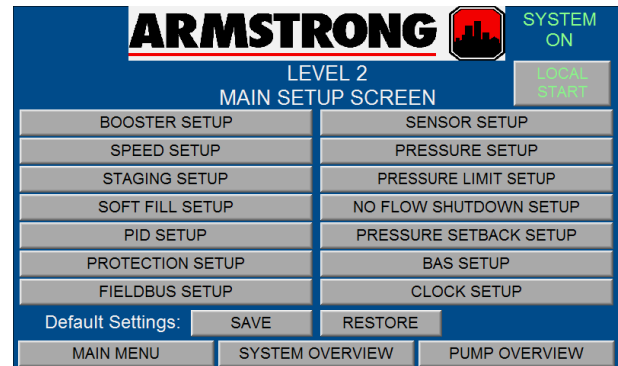

- 9 The screen changes to **Pump overview**. Press **Pump 1** button.

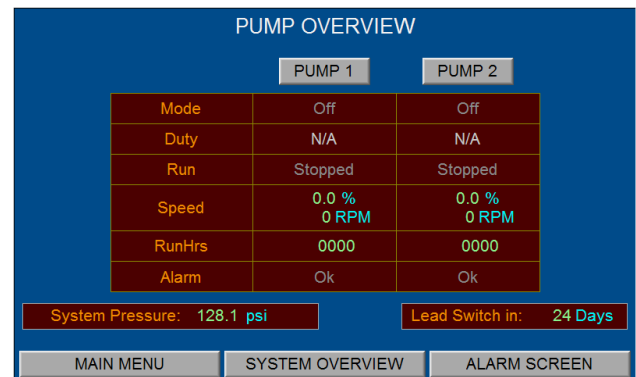

- 10 **Pump 1 control** is popped up. Press **Auto** button. Close the window by touching the crossing mark button, the screen changes to **Pump overview** again.



30

- 11 Press **Pump 2** button in **Pump overview** screen. **Pump 2 control** is popped up. Press **Auto** button. Close the window by touching the crossing mark button.



- 12 Repeat the **STEP 10**. Set all the pumps in **Auto**.
- 13 The ivs will start up automatically.

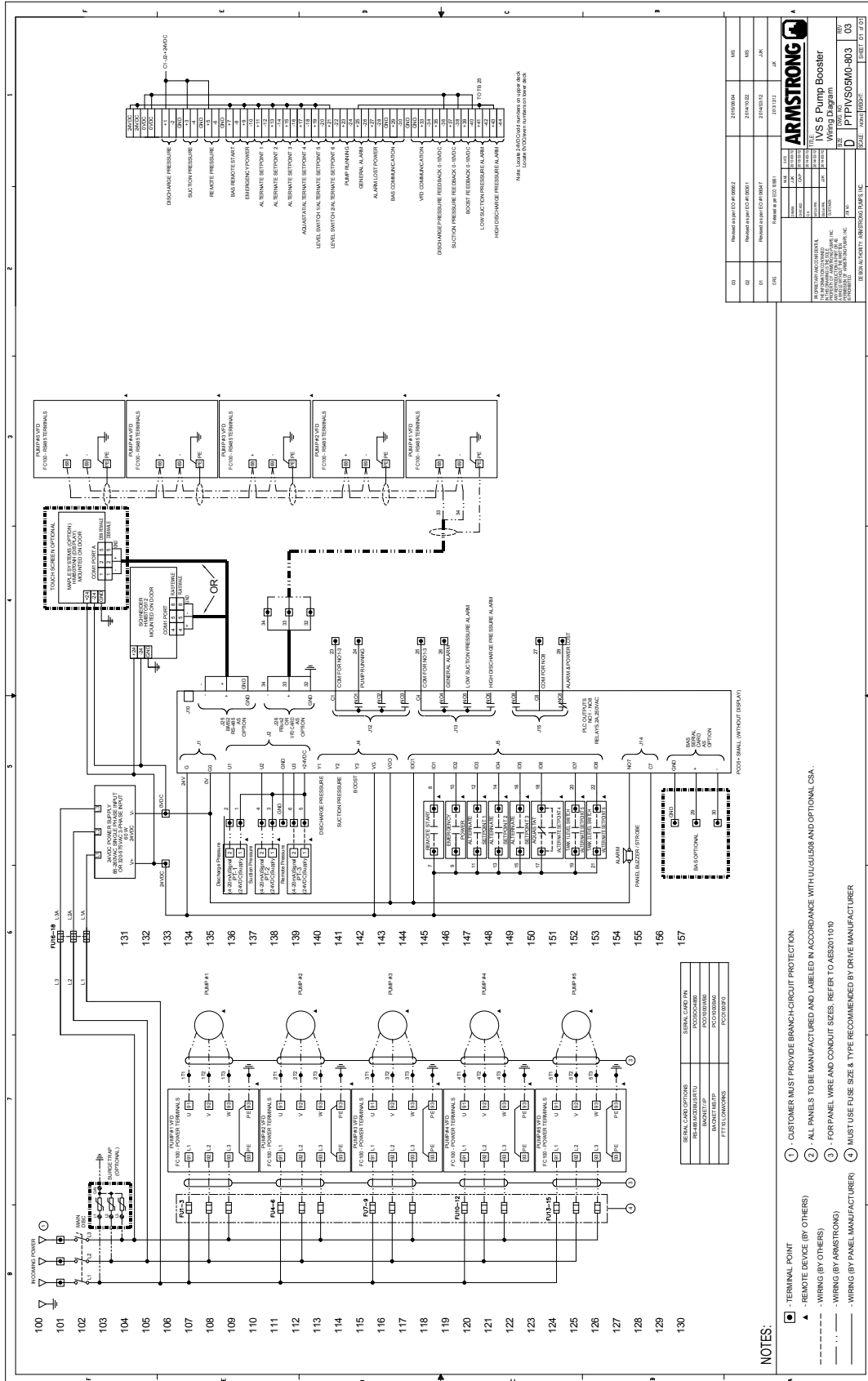

**TORONTO**

23 BERTRAND AVENUE  
TORONTO, ONTARIO  
CANADA  
M1L 2P3  
+1 416 755 2291

**BUFFALO**

93 EAST AVENUE  
NORTH TONAWANDA, NEW YORK  
U.S.A.  
14120-6594  
+1 716 693 8813

**BIRMINGHAM**

HEYWOOD WHARF, MUCKLOW HILL  
HALESOWEN, WEST MIDLANDS  
UNITED KINGDOM  
B62 8DJ  
+44 (0) 8444 145 145

**MANCHESTER**

WOLVERTON STREET  
MANCHESTER  
UNITED KINGDOM  
M11 2ET  
+44 (0) 8444 145 145

**BANGALORE**

#59, FIRST FLOOR, 3RD MAIN  
MARGOSA ROAD, MALLESWARAM  
BANGALORE, INDIA  
560 003  
+91 (0) 80 4906 3555

**SHANGHAI**

NO. 1619 HU HANG ROAD, XI DU TOWNSHIP  
FENG XIAN DISTRICT, SHANGHAI  
P.R.C.  
201401  
+86 21 3756 6696

**SÃO PAULO**

RUA JOSÉ SEMIÃO RODRIGUES AGOSTINHO,  
1370 GALPÃO 6  
EMBU DAS ARTES  
SAO PAULO, BRAZIL  
+55 11 4781 5500

ARMSTRONG FLUID TECHNOLOGY  
ESTABLISHED 1934

ARMSTRONGFLUIDTECHNOLOGY.COM

**MAKING  
ENERGY  
MAKE  
SENSE™**