

Design Envelope (Permanent Magnet) 6800G and 6900

Booster Packages

Installation and
operating instructions

File No: 62.8071EC
Date: JULY 20, 2023
Supersedes: NEW
Date: NEW

—

—

—

—

CONTENTS

A	DESIGN ENVELOPE BOOSTER SYSTEMS INSTALLATION INSTRUCTIONS	4	1.3.10 SPEED SETUP	22	
B	INTELLIGENT VARIABLE SPEED BOOSTER SYSTEMS: BASIC OPERATING FUNCTION	5	1.3.11 PID SETUP	22	
C	VARIABLE SPEED BOOSTER SYSTEMS: GENERAL ARRANGEMENT SCHEMATIC DIAGRAM	7	1.3.12 PRESSURE SETBACK SETUP	22	
D	DESIGN ENVELOPE BOOSTER PACKAGE COMMISSION CHECK SHEET	8	1.3.13 BAS SETUP	22	
E	BOOSTER PANEL PARAMETER CHECKLIST	9	1.3.14 FIELDBUS SETUP	22	
1.0	INTRODUCTION	13	1.3.15 FLOW SETUP	22	
1.1	OPERATION SCREENS	14	1.3.16 CLOCK SETUP	23	
1.1.0	MAIN MENU	14	1.3.17 ALTERNATE DISCHARGE PRESSURE SETUP	23	
1.1.1	SYSTEM OVERVIEW	14	2.0	INSTALLER SCREENS	23
1.1.2	PUMP OVERVIEW	15	2.1	LEVEL 1 SETUP SCREENS	23
1.1.3	PUMP 1 CONTROL SCREEN	15	2.1.0	LEVEL 1 SETUP MENU	23
1.1.4	LOGIN SCREEN	16	2.1.1	BOOSTER SETUP	24
1.1.5	MAIN SERVICE SCREEN	16	2.1.2	SENSOR SETUP	24
1.1.6	SERVICE OVERVIEW SCREEN	17	2.1.3	PRESSURE SETUP	25
1.1.7	COMMISSION SCREEN	17	2.1.4	PRESSURE LIMIT SETUP 1	26
1.1.8	ENERGY SCREEN	18	2.1.5	PRESSURE LIMIT SETUP 2	26
1.1.9	FLOW SCREEN	18	2.1.6	STAGING SETUP	27
1.2	ALARM MANAGEMENT SCREENS	19	2.1.7	SOFT FILL SETUP	27
1.2.1	ALARMS SCREEN	19	2.1.8	NO FLOW SHUTDOWN SETUP	28
1.2.2	ALARM & HELP SCREEN	19	2.1.9	SPEED SETUP	29
1.2.3	ALARM INFORMATION SCREEN	19	2.1.10	PID SETUP	29
1.2.4	ALARM HISTORY SCREEN	20	2.1.11	PRESSURE SETBACK SETUP	30
1.3	LEVEL 0 SETUP SCREENS	20	2.1.12	PROTECTION SETUP	30
1.3.0	LEVEL 0 SETUP MENU	20	2.1.13	BAS SETUP	31
1.3.1	BOOSTER SETUP	21	2.1.14	FIELDBUS SETUP	31
1.3.2	SENSOR SETUP	21	2.1.15	CLOCK SETUP	31
1.3.3	PRESSURE SETUP	21	3.0	FACTORY SCREENS	32
1.3.4	PRESSURE LIMIT SETUP 1	21	3.1	OPERATION SCREENS	32
1.3.5	PRESSURE LIMIT SETUP 2	21	3.2	ALARM MANAGEMENT SCREENS	32
1.3.6	PROTECTION SETUP	21	3.3	LEVEL 2 SETUP SCREENS	32
1.3.7	PUMP STAGING SETUP	21	3.3.0	LEVEL 2 SETUP MENU	32
1.3.8	SOFT FILL SETUP	22	3.3.1	PRESSURE LIMIT SETUP	33
1.3.9	NO FLOW SHUTDOWN SETUP	22	3.3.2	PID SETUP	34
			3.3.3	FIELDBUS SETUP	34
			3.3.4	CLOCK SETUP	35
			4.0	SYSTEM START-UP PROCEDURE	35

Armstrong Design Envelope Boosters are completely factory-assembled, tested, adjusted, and shipped to the job site as integral units ready to receive suction and discharge piping and incoming power supply. These instructions describe the procedures to be followed during installation, commissioning and operation to ensure optimum performance and reliability. When contacting the factory for assistance, please provide the unit Serial Number and other pertinent data, such as motor amperage, voltage and suction and discharge pressures.

**A DESIGN ENVELOPE BOOSTER SYSTEMS
INSTALLATION INSTRUCTIONS**

Storage - Make sure that all components are kept as clean as possible. Do not remove the crating or plastic wrapping until the unit is ready for installation.

Rotate the pump and motor shaft periodically (at least monthly) to keep rotating element free and bearings fully functional.

Because boosters are tested to design conditions prior to shipment, some water may remain within internal components. Internal rusting can be prevented by removing the plugs at the top of the pump casing and drain or air blow out all water to prevent rust buildup or the possibility of freezing. Be sure to reinstall the plugs when the unit is made operational.

Uncrating - After removal of the unit from the crate, check to see that the equipment is in good order and that all components are received as called for on the packing slip. Any shortages or damage should be reported immediately.

Location - Locate the unit where it is easily accessible for inspection and servicing. Provide adequate room for pump withdrawal and also for access to the interior of the control panel.

As per NEC 110.26, a minimum of 3ft of clearance is required in front of the booster panel. See below diagram for clearance details.(FIG 1)

FIG 1: CLEARANCE FOR DESIGN ENVELOPE BOOSTERS

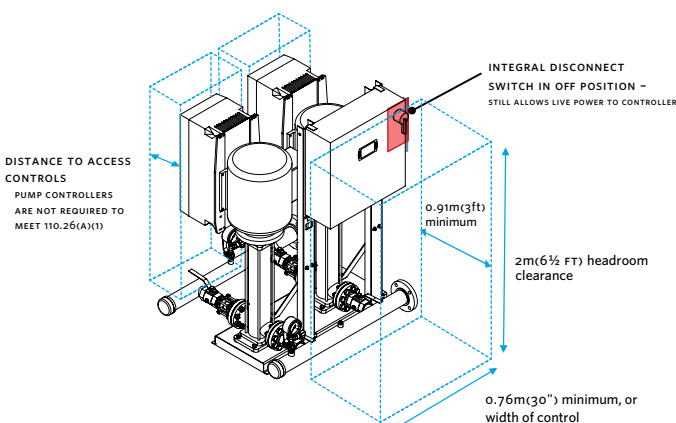

The standard panel enclosure rating for Design Envelope (Permanent Magnet) boosters is UL Type 4.

Design Envelope models are supplied with either TEFC or ODP motors and drives with UL Type 12 enclosure rating. DEPM models are only available with TEFC motors with IP55 enclosure.

A minimum of 2" (50 mm) clearance is required at the fan inlet to facilitate airflow.

To avoid the DEPM motors from getting overheated, the ambient temperature is not to exceed 113°F (45°C). Operating in higher ambient temperatures will require derating of the DEPM motors, as per below

POWER RANGE	DEPM FRAME SIZE	OUTPUT CURRENT AVAILABLE BY % BASED ON AMBIENT TEMPERATURE		
		113°F (45°C)	122°F (50°C)	131°F (55°C)
0 - 3HP (0-2.2KW)	90	100%	100%	100%
5HP (3.7KW)		100%	90%	80%
7.5HP (5.5KW)		100%	80%	60%
0 - 7.5HP (0-5.5KW)	112	100%	100%	100%
10HP (7.5KW)		100%	80%	60%

Foundation - The foundation should be sufficiently substantial to absorb any vibration and to form a permanent rigid support for the base plate. A good concrete foundation should be approximately 2½ times the weight of the packaged unit.

Foundation bolts - Foundation bolts of the proper size should be arranged as shown in the sketch, with a pipe sleeve embedded in the concrete to permit adjustment of the bolts after the concrete has been poured. Use sleeves with a diameter 2½ times the diameter of bolts.



Leveling - When the unit has been placed on its foundation, insert metal wedges approximately 1" thick on either side of the foundation bolts under the base plate. Adjust the wedges until the suction and discharge headers are truly horizontal. Check this by means of a spirit level on the suction and discharge flanges. When leveling is complete, the foundation bolts should be tightened evenly and firmly. Do not over tighten the bolts at this stage.

Piping - Both the suction and discharge pipes should be independently supported so that no strain is imposed on the packaged unit when the pipes are connected. All connecting pipe work should be accurately located-do not attempt to force the suction and discharge pipes into position.

Incoming Supply - The incoming power supply should be brought in through the bottom of the panel adjacent to the main terminals. Note that this is the only electrical connection required at the panel.

Adjustments - The touch display Interface provides access for the adjustable set points, alarms and timers. No other devices require adjustments.

The operation and adjustment procedures for the set points, alarms and timers are described in the manual.

Note carefully, however, that all devices are pre-set at the factory and will normally require no further adjustment.

Automatic operation and Initial Run - To set the unit for automatic operation, turn all the isolating valves to the fully open position, close the main disconnect, ensure all pumps are already in the **AUTO** position, all drives are already in the Auto On position so go to main screen, put the Remote Start / Local Start switch in Local start position and the booster system will run. If start/stop of the booster is controlled by the remote BAS dry contact switch put the Remote Start / Local Start switch in Remote Start position and close BAS remote switch. **In initial run note any problems (PAGE 8).**

B INTELLIGENT VARIABLE SPEED BOOSTER SYSTEMS: BASIC OPERATING FUNCTION

Every Armstrong Intelligent variable speed (Design Envelope including permanent magnet) Packaged system - regardless of size or power rating - incorporates the twelve basic operating functions as follows:

- 1 For Continuous run and Intermittent systems - Sequential starting and stopping of the pumps is achieved by a combination of pump speed, power and set point pressure. A set point pressure control will bring on a lag pump if the lead pump(s) are operating at full speed and not maintaining set point pressure. When the lead pump reaches 100% speed or maximum motor nameplate power and the system pressure is not being satisfied, the second pump (lag pump) is automatically started. When a lag pump is started up, a time clock in the pump controller keeps it operating for a minimum of a 1 minute period to prevent the pump from cycling on and off. On a three, four or five pump system, the third, fourth and fifth pumps are brought on in the same way when the combined pumps reach 100% speed or maximum motor nameplate power and the system pressure is not being satisfied. A similar sequence of events takes place in reverse on decreasing demand.
- 2 Pump RPM is controlled by a Variable Frequency Drive (VFD) connected directly to each individual pump motor on DE models. For DEPM models, pump RPM is controlled by ECM driver integrated into motors. An analog signal from the discharge pressure transmitter is compared to a desired set point entered in to the operator panel. The pump logic controller then instructs the VFD/ECM driver to either speed up or slow down in order to meet or maintain the system set point pressure.
- 3 A low suction pressure or level shutdown alarm is included with every system to protect the pumps from a loss of suction pressure or water supply. If the water supply pressure, as measured by the suction pressure transmitter falls to 5 psi or the tank level switch (supplied by other) sends a signal to the panel, the pump controller will prevent the pumps from running. This condition is indicated by a **low suction pressure** or **low suction level** alarm description on the control panel alarm page.
- 4 To protect plumbing the booster come with standard alarm functions for:
 - High discharge pressure shutdown
 - Low discharge pressure shutdown
- 5 Should a pump or drive fail to operate, the next pump in sequence starts up automatically.
- 6 Lead pump status is alternated after every 24 hrs of operation, as a default. The first pump placed in the auto position is considered the lead pump. Hand off-Auto switches are located in the individual pump control screens. Alternation includes all duty and optional standby pumps.
- 7 No-flow shut down is achieved through drive parameter control and pressure monitoring. Once a no-demand condition is achieved for a period of 5 minute, the controller will increase the pump speed and charge the drawdown tank or system an additional 5 psi before shutting down.
- 8 In every system restart, once started, the pumps ramp up to meet the required set point pressure.
- 9 The Soft fill mode is enabled when the booster system is first powered and after any power disruption. Once started, the pumps ramp up slowly from the Soft Fill set point pressure to nominal pressure in a five minute period.
- 10 The Pressure Setback Mode is enabled as standard. The system pressure set point is reduced linearly, as a percentage, as flow decreases.
- 11 When the Emergency power mode is enabled upon receiving an Emergency Power digital signal, power and control will be restricted to the lead pump only. The Low system pressure shutdown will be disabled and the

6

Emergency power low system pressure alarm will be enabled. The one pump will operate for the duration of the Emergency power mode and the system will switch to Normal Mode when a signal is not present.

- 12 Controllers are supplied with 3 analog inputs and 8 digital Normally Open (NO) dry contacts for remote monitoring.

Analog

- 1, 2 - Discharge pressure transducer
- 3, 4 - Suction pressure transducer (optional)
- 5, 6 - Remote pressure transducer (optional)

Digital

- 7, 8 - Remote start (optional)
- 9, 10 - Emergency power (optional)
- 11, 12 - Use alternate setpoint 1 (optional)
- 13, 14 - Use alternate setpoint 2 (optional)
- 15, 16 - Use alternate setpoint 3 (optional)
- 17, 18 - Use aquastat (optional)/
 Alternate setpoint 4 (optional)
- 19, 20 - Use level switch 1 (optional)/
 Alternate setpoint 5 (optional)
- 21, 22 - Use level switch 2 (optional)/
 Alternate setpoint 6 (optional)

Communication option

(Serial connection except for BACnet (IP/ENET))

- 29,30 - BAS communication
- GDN - BAS/VFD/DEPM Ground
- 33,34 - VFD/DEPM communication

**C VARIABLE SPEED BOOSTER SYSTEMS:
GENERAL ARRANGEMENT SCHEMATIC DIAGRAM**

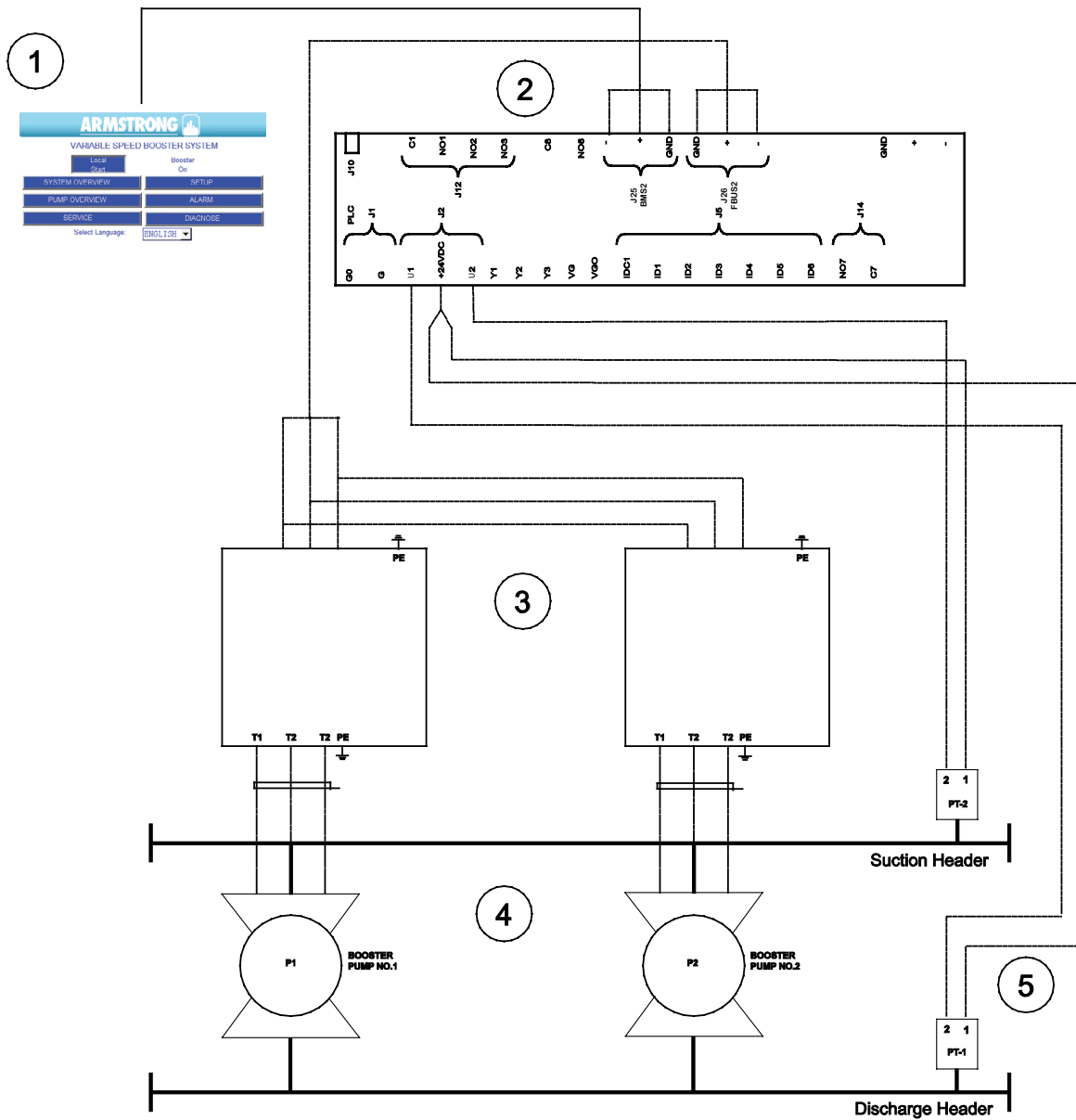

- | | |
|---|--------------------------|
| 1. Operator Interface | 4. Booster Pumps |
| 2. Programmable Logic Controller (PLC) | 5. Pressure Transmitters |
| 3. Variable Frequency Drives (VFD) / ECM Driver of DEPM Motor | |

D DESIGN ENVELOPE BOOSTER PACKAGE COMMISSION CHECK SHEET

The following is a step-by-step guide for starting up and commissioning Armstrong Design Envelope (Permanent Magnet) boosters **One check sheet is to be completed per system!** You must follow and fill out all fields below to ensure that all aspects of the booster is checked and set up for proper operation. Once complete, this sheet requires that end-user / general contractor sign off on the work rendered as final approval that the pump is

functioning as intended. Please submit this commissioning check sheet along with your work invoice / startup claim in order to ensure prompt and timely payment of work rendered!

NO CHECK SHEET + STARTUP DATA SHEET = INCOMPLETE STARTUP!

UNLESS STATED OTHERWISE ALL FIELDS ARE MANDATORY!

Project name: _____
Building address: _____
Contractor name: _____
Site contact name: _____ Site contact tel. #: _____
Your company: _____ Your name: _____
Pump model: _____ Booster serial #: _____
Pump serial #(s): _____ Sales order #: _____

- NOTES:**
- GC = General Contractor
 - BAS = Building Automation System

PRE-STARTUP PACKAGE:

YES NO N/A

- Do you have the Booster Order Annexe?
- Do you have a copy of the electrical wiring diagram?
- Do you have a copy of the Design Envelope Booster Installation and Operation Manual?
- OPTIONAL: Do you have the pump-specific variable speed curve with duty point indicated?

PRE-STARTUP ARRANGEMENTS:

YES NO N/A

- Verify with GC that water and power is available and ready to the pump
- Verify with GC that pumps can be run without damage to system
- Verify with GC that BAS is wired to Design Envelope Booster controller and ready to go (if applicable)
- Verify with GC that BAS contractor will be there on site to meet you (if applicable)

BEFORE POWER UP CHECKLIST:

DONE

- Check booster installation for proper mounting as per Installation & Operation Manual instructions
- Check incoming voltage across the lines and record here: L1 _____ L2 _____ L3 _____
Note: Voltage should be no more than ±10% of design voltage
- Check if booster set is to be controlled remotely by BAS start / stop remote contact with BAS contractor:
 - YES:** Check if BAS remote dry contact is wired across terminals 7 & 8 inside control panel.
 - NO:** Move on to the next step.
Note: Contacts close = booster runs. Contacts open = booster stops.
- Open up and bleed pump seal flush line to verify no air is locked inside seal / seal lines. If the pumps are Vertical Multi Stage (VMS) pumps, make sure the vertical column is bled for air by cracking open the bolt located at the top of the stages.
- Record the actual suction pressure from the gauge here: Suction _____
Verify if suction pressure is within range of design suction pressure on Order Annex.

E BOOSTER PANEL PARAMETER CHECKLIST

Note: When changing the system discharge setpoint press the **Update limits yes** button to automatically update the High and Low pressure limits for the discharge and suction pressure.

Factory adjustable settings

CATEGORY	PARAMETER [UNITS]	OPTION LIST OR RANGE	DEFAULT	NOTE
System Info	Pump Model	NA	configured	
	Number of Pumps	2-5	as configured	
	Standby Pump	Yes, No	No	
	Drive Type	FC102, FC101, iECM	FC102	
	Drive (1-5) Type iECM	(HPI 1.0), (71, HPI 2.0)	(71, HPI 2.0)	
	Motor Frequency [Hz]	50, 60	60	
	Pump Rated Power [kW]	0.7-45.0	as configured	
	Pump Motor Rated Speed [rpm]	0-9999	3600	
	Maximum Design Flow of the Booster System	NA	configured	
	Flow Offset	0.75-1.2	1.0/as configured	to match calculated flow to measured flow
	Suction Pressure Sensor	Enable, Disable	Enable	
	Discharge Pressure Sensor	Enable, Disable	Enable	
	Remote Pressure Sensor	Enable, Disable	Disable	
	System Discharge Pressure Control Sensor	Local, Remote	Local	
	Level Switch 1	Enable, Disable	Disable	
Level Switch 2	Enable, Disable	Disable		
Units	Units (pressure)	psi, bar, kPa, ft, m	psi	
	Design Flow Unit	US GPM, UK GPM, m ³ /hour, l/sec	US GPM	
	Displayed Flow Units	US GPM, UK GPM, m ³ /hour, l/sec	Set by User	
Setpoint	Local Discharge Pressure Setpoint[psi]	0-max working press.	as configured	
	Remote Discharge Pressure Setpoint [psi]	0-max working press.	as configured	
	Number of Alternate Discharge Setpoints	0-6	0	
	Alternate Discharge Pressure Setpoints 1 to 6 [psi]	0-max working press.	Sys. Disch. Press. S.P.	
	Pump Minimum Speed Setpoint [%]	0-98	40	
	Pump Maximum Speed Setpoint [%]	0-100	100	
	Pump Start Speed Setpoint [%]	40-98	60	
Pump Default Speed [%] when all discharge sensors fail, and the Aquastat is enabled	0-100	70		

CATEGORY	PARAMETER [UNITS]	OPTION LIST OR RANGE	DEFAULT	NOTE
Limits	Update Limits or Auto Set Pressure Limits (button)	Used to calculate all pressure limits and No Flow Shutdown boost pressure	NA	updates (sets up) all pressure limits and No flow shutdown boost pressure proportionally to the System discharge pressure setpoint.
	Suction Pressure Sensor Range Limit [psi]	0-3200	300	
	Discharge Pressure Sensor Range Limit [psi]	0-3200	300	
	Remote Pressure Sensor Range [psi]	0-3200	300	only selectable if Remote Pressure Sensor is enabled
	High Suction Pressure Limit (on/off)	Enable, Disable	Enable	
	High Suction Pressure Limit (value) [psi]	Low Suction Shutdown + 5 up to max working press.	Sys. Disch. Press. Setpoint	It is updated (setup) by pressing Update limits.
	Low Suction Pressure Limit [psi]	0-Sys. Disch. Pressure	5	It is updated (setup) by pressing Update limits.
	Booster Stop if Suction Sensor Fail	Enable, Disable	Disable	
	Low Discharge Pressure Limit [psi]	0-Sys. Disch. Pressure*0.8	Pressure Setback at start *0.8	It is updated (setup) by pressing Update limits.
	High Discharge Pressure Limit (on/off)	Enable, Disable	Disable	
High Discharge Pressure Limit (value) [psi]	Low Suction Shutdown + 5 up to max working press.	Sys. Disch. Press. S.P. + 15	It is updated (setup) by pressing Update limits	
Safeties	Discharge High Alarm Auto/Manual Reset	Manual, Auto	Auto	
	Discharge High Alarm Delay [seconds]	1-15	10	
	Factory High System Shutdown Pressure [psi]	0-3276.7	200/configured	It is Maximum Working Pressure based on package configuration
	Emergency Power Mode	Enable, Disable	Disable	
	Number of Running Pumps in Emergency Power Mode	0-5	1	
	Emergency Power Mode Low Discharge Pressure Limit [psi]	0-Sys. Disch. Pressure*0.5	Sys. Disch. Pressure*0.2	It is updated (setup) by pressing Update limits.
	EOC (End of Curve) Protection	Enable, Disable	Disable	
	EOC (End of Curve) Head Coefficient [% of Local Discharge Pressure S.P.]	0-100	90	
	Aquastat Protection	Enable, Disable	Disable	
	Airlock Protection	Enable, Disable	Disable	
	Airlock Shutdown Pump Power Setpoint [%Pump Rated Power]	0-30	15	
Airlock Shutdown Delay [seconds]	0-600	20		
Pump Sequencing	Lead Pump Switch Time [hours]	1-168	24	operational time of lead pump before switching
	Pump Stage Off Controlling Variable	Speed, Power, Speed or Power, Speed and Power	as Configured	
	Pump Stage On Speed [%]	33-100	97	
	Pump Stage Off Speed [%]	33-98	70	
	Pump Stage Off Power [%]	70-200	90	
	Pump Stage On Delay [seconds]	0-999	5	
	Pump Stage Off Delay [seconds]	0-999	30	

CATEGORY	PARAMETER [UNITS]	OPTION LIST OR RANGE	DEFAULT	NOTE
Soft Fill Mode	Soft Fill Mode	Enable, Disable	Enable	
	Soft Fill Start Pressure Setpoint [% of System Discharge Pressure Setpoint]	20-100	50	
	Soft Fill Run Pressure Setpoint [% of System Discharge Pressure Setpoint]	40-100	65	
	Soft Fill Ramp Time [seconds]	0-999	60	
No Flow Shut Down	No Flow Shutdown	Enable, Disable	Enable	
	No Flow Shutdown Delay [seconds]	30-999	300	
	No Flow Shutdown Controlling Variable	Power, Speed	Power	
	No Flow Shutdown Variable Setpoint [% Selected Power or Speed]	0-100	70	
	No Flow Shutdown Wait Time [seconds]	0-999	30	
	No Flow Shutdown Boost Pressure [default psi]	0-M.W.P. less Sys. Disch. Press. S.P.	5PSI, 11FT, 35KPA, 0.34BAR, 3.5M	It is updated (setup) by pressing Update limits after Pressure units are selected.
	Wake up pressure, bar only	0-2.00	0.34	
PID	PLC PID Proportional Gain [%/sec]	1-99	10	
	PLC PID Speed Up Limit [%/sec]	0.2-99.9	1	
	PLC PID Speed Down Limit [%/sec]	0.2-99.9	3	
Power Limit	Power Limit	Enable, Disable	Disable	
	Motor Power Limit [%]	100-130	103	
	Power Limit Speed Reduction [%/sec]	0.2-5.0	0.5	
Pump Alarm Auto Reset	Pump Alarm Auto Reset	Enable, Disable	Disable	
	Pump Alarm Auto Reset Delay [sec]	1-9999	900	
Pressure Setback	Pressure Setback	Enable, Disable	Enable	
	Pressure Setback Setpoint [% of System Discharge Pressure Setpoint]	80-100	85	
	Pressure Setback Control Mode	Linear, Quadratic	Quadratic	
BAS	BAS Interface Protocol	Modbus, Lonworks, BACnet MS/TP, BACnet IP, none	none	
	BAS Interface Node	1-28	1	
	BAS Interface Baud Rate [bits/sec]	9600-115200	19200	
	FieldBus Setup (source)	FBus2, Fieldbus Card	FBus2	

RUNNING:

DONE

- Check and make sure all pumps are in the **auto** position (on PLC and VFD, where applicable)
- Turn all the isolating valves to the fully open position
- Put the Remote Start / Local Start switch in Local Start position and the booster system will run. If start/stop of the booster is control by the remote BAS dry contact switch put the Remote Start / Local Start switch in Remote Start position and close BAS remote switch.
- In initial run check for noise, vibration, etc., and any leaks in the pipework.
- Pumps should continue to maintain set point

NO FLOW SHUTDOWN (NFS) TEST:

DONE

- Check and make sure all pumps are in the **auto** position (on PLC and VFD, where applicable)
- When system is running, isolate booster system from building loop (run it against a deadhead)
- Pumps should continue to maintain set point while ramping down and eventually shutting down to one pump only
- The single pump after 300s (default) will ramp up to your NFS Pressure Boost setpoint and then shut down

SIGNOFF:

By signing off on this startup checklist, both parties hereby accept that the equipment listed in this checklist has been properly verified to be fully operational and functioning as per the sales order for the equipment listed.

Startup Technician Name (Please print):

Customer Name (Please print):

Startup Technician Signature:

Customer Signature:

Date (mm/dd/yyyy):

/ /

Date (mm/dd/yyyy):

/ /

1.0 INTRODUCTION

The integrated controller HMI is divided in three set of screens: Operation, Setup, and Alarm.

The Operation Screens are used by the users to view and control the Pumps. The Setup Screens are used to set, view, save, and restore the system specific settings (i.e. pressure set point and limits, soft fill mode, pumps parameters, etc.). The Alarm screens are used to display the current alarms, store and display history alarms, give helpful information on each alarm.

The list of screens in each set is as follow:

OPERATION SCREENS

- Main menu
- System Overview
- Pump Overview
- Pump 1 Control
- Pump 2 Control
- Pump 3 Control
- Pump 4 Control
- Pump 5 Control
- Login
- Service Overview

The System Screens can be accessed without any password.

ALARM SCREENS

- Alarm
- Alarm and Help
- Alarm History

The Alarm Screens can be accessed and operated (such as pressing a **reset** button) without any password.

SETUP SCREENS

The Setup Screens are divided in three levels. All the three levels have the same number of screens with different level of access. Level 0 setup screens are for viewing only and no adjustment can be made. Level 1 setup screens can be used for changing the system setup, restoring the system factory defaults except for the PID parameters in the PID Setup Screens. Level 2 setup screens can be used for changing the system setup, and saving and restoring the system factory defaults. To access Level 1 and level 2 Setup Screens an operator need to enter the proper password. Level 2 password is for factory setup.

The list of Setup Screens for every level is as follow:

- Setup Menu
- Booster Setup
- Sensor Setup
- Speed Setup
- Staging Setup
- Pressure Setup
- Pressure Limit Setup
- Soft Fill Setup
- No Flow Shutdown Setup
- PID Setup
- Pressure Setback Setup
- Protection Setup
- BAS Setup
- FieldBus Setup
- Clock Setup

The Level 1 Setup Screens also have a set of **Restore All Default Settings** to restore the default setup values on each screen. The Level 2 Setup Screens have a set of **Restore All Default Settings** and **Save All Default Settings** to restore or save the default values on each screen.

SYSTEM FUNCTIONS

The System functions of the HMI operator interface include the Operator Screens, the Installer Screens, and the Factory Screens. To access the Installer Screens, the user is required a level 1 password. To access the Factory Screens, the user is required a level 2 password. There is no password requirement to access the Operator Screens.

OPERATOR SCREENS

Operator Screens include operation screens, alarm management screens and level 0 setup screens. These screens can be accessed without any password, and level 0 setup screens are for viewing only.

1.1 OPERATION SCREENS

See the following table

1.1.0 MAIN MENU



This is the screen the operator sees when powering up the unit.

- 1 Press **System Overview** to view the layout of the system, system pressure setpoint, discharge pressure, remote pressure, suction pressure and boost pressure, pumps speed and status.
- 2 Press **Pump Overview** to view pumps status, speed, run time and alarm.
- 3 Press **Alarm** to view any alarm condition that might have occurred.
- 4 Press **Setup** for pump, sensor, pressure, limit and soft fill setup (password protected).
- 5 Press **Service** to view pumps status, VFD/DEPM motor status, communication, faults and alarms.
- 6 Press the drop-down list beside **Select Language** to select other display language for all the screens.
- 7 Any alarm occurred in the system will be displayed in scroll bar in the bottom area.

1.1.1 SYSTEM OVERVIEW

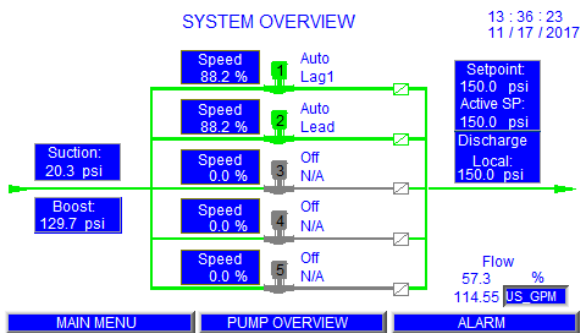

- 1 The active System pressure setpoint is displayed.
- 2 Discharge and suction pressure are displayed.
- 3 Remote pressure is displayed if the remote sensor is enabled in **Sensor Setup** screen.
- 4 Boost pressure is displayed.
- 5 Pumps' running status, alarm status, Auto/On/Off/Hand status, duty/standby order and speed are displayed.
- 6 Pressing the pump icons will change the current screen to the pump control screen.
- 7 Press the buttons on the menu at the bottom to bring up the desired screen.

1.1.2 PUMP OVERVIEW

PUMP OVERVIEW

	PUMP 1	PUMP 2	PUMP 3	PUMP 4	PUMP 5
Mode	Auto	Auto	Off	Off	Off
Lead	Lag1	Lead	N/A	N/A	N/A
Run	Run	Run	Stop	Stop	Stop
Speed	88.2 % 3175 RPM	88.2 % 3175 RPM	0.0 % 0 RPM	0.0 % 0 RPM	0.0 % 0 RPM
RunHrs	0046	0046	0000	0000	0000
Alarm	OK	OK	OK	OK	OK

Discharge Pressure: 150.0 psi Lead Switch in: 1 Hrs

MAIN MENU SYSTEM OVERVIEW ALARM

- 1 **Mode** shows pump operation mode: Hand, Off, or Auto.
- 2 **Lead** shows which pump is lead, lag, or standby.
- 3 **Run** shows whether the pump is running or stopped
- 4 Speed is displayed in both % value of full speed and absolute RPM.
- 5 Run Hours re displayed and can be reset in the pump control screen.
- 6 Alarm will be displayed if there is a problem with the pump.
- 7 Pressing the **Pump 1** button will bring up the **pump 1 control** screen to view and control pump parameters. This applies to the other corresponding pumps.
- 8 Press the buttons on the menu at the bottom to bring up the desired screen.

1.1.3 PUMP 1 CONTROL SCREEN

PUMP OVERVIEW
PUMP 1 CONTROL

Mode		Ref	Feedback	Speed
<p>Hand Off Auto</p>		100	100	11.3 A 342.6 V 6.1 kW
Lead:	Lag1			LEAD
Run:	Run			Speed 88.2 % 3175 RPM
Run Hours:	0045			Hand Speed 0.0 %
Run Hours:	Reset			
Fault:	OK			
Alarm:	OK			

Di MAIN MENU SYSTEM OVERVIEW ALARM

This screen is to control the pump, Hand, Off, Auto, Lead or Lag mode and hand speed

- 1 Press the **Hand, Off, Auto** buttons to select the desired mode.
- 2 The pump mode is displayed under these buttons, no display means **N/A**.
- 3 Press the **Lead** button to set the pump as lead pump (the other pumps become lag).
- 4 When in **Hand** mode, enter the desired speed in the **Hand Speed** box.
- 5 When in **Auto** mode, the speed of the pump is automatically determined by the PLC controller.
- 6 Pump duty is displayed: Lead, Lag1, Lag2, Lag3, Lag4, or Standby.
- 7 Pump status is displayed (Run or Stop).
- 8 Run Hours indicates the pump total running time since the last reset and can be reset by pressing the **Reset** button.
- 9 Drive fault will be displayed if there is a problem with the VFD/DEPM motor, otherwise it will display **Ok**.
- 10 Alarm will be displayed if there is a problem with the pump, otherwise it will display **Ok**.
- 11 Controller output speed (Reference speed sent to the VFD/ECM driver) is displayed in % value of pump full speed
- 12 Pump actual speed (Feedback from the VFD/ECM driver) is displayed in % value of pump full speed and RPM.
- 13 VFD/DEPM motor amps, voltage and power are displayed.
- 14 Press the buttons on the menu at the bottom to bring up the desired screen.

1.1.4 LOGIN SCREEN

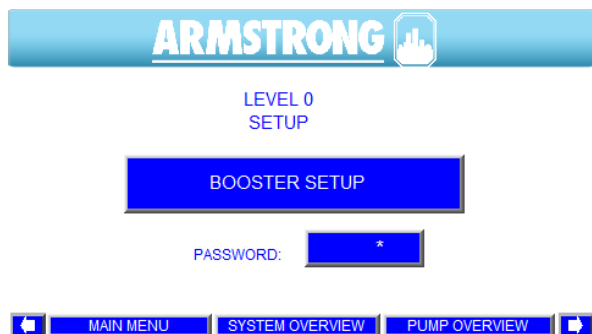

- 1 From the **Main Menu** screen, pressing the **Setup** button will call up this screen.
- 2 In order to be able to modify any of the Setup parameters you must Login with the proper password.
- 3 There are 3 levels of setup screens. Level 1 and level 2 require operator to input password. Level 0 will allow viewing the setup values only. Level 1 will allow changes to setup values and to restore the system factory defaults except for the PID parameters. Level 2 will allow changes to all the setup values, and to save or restore all the system factory defaults. All the three levels will allow controlling the pumps.
- 4 Pressing the password area to the right of **Log In:** will pop-up this keypad. Inputting the password through the keypad, then pressing the **Ent** button on the keypad will change the appropriate level. Pressing the **Booster Setup** button allows the user to change or view parameters.

1.1.5 MAIN SERVICE SCREEN

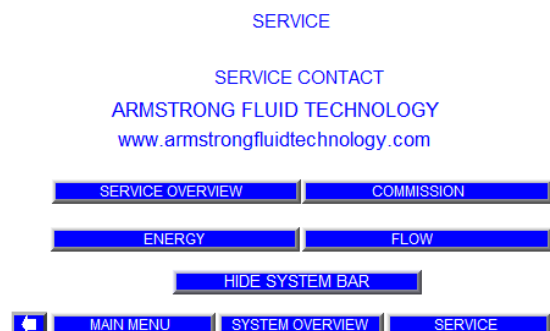

- 1 The service contact screen displays the Armstrong Website where the user can access to attain the local service support information.
- 2 This screen allows access to the Service Overview, Commission, Energy, Flow, and Hide System Bar

1.1.6 SERVICE OVERVIEW SCREEN

SERVICE OVERVIEW									
Drive	A	V	kW	Speed%	RPM	Run	Fault	Hand	
1	11.3	342.6	6.1	88.2	3175	Run	OK	Auto	Hand
2	11.3	342.7	6.1	88.2	3175	Run	OK	OK	Hand
3	0.0	0.0	0.0	0.0	0	Stop	OK	OK	Hand
4									
5									

Modbus Communication				
	Lead	Mode	Message	Alarm
1	Lag1	Auto	Timeout	OK
2	Lead	Auto	Timeout	OK
3	N/A	Off	Timeout	OK
4				
5				

Suction:	Setpoint:
20.3 psi	150.0 psi
Boost:	Active SP:
129.7 psi	150.0 psi
Discharge	Local:
	150.0 psi

MAIN MENU	SYSTEM OVERVIEW	SERVICE
-----------	-----------------	---------

- Drive** means VFD or DEPM motor.
- A** is the actual pump motor current.
- V** is the actual pump motor voltage.
- kW** is the actual pump motor power.
- Speed%** is the actual motor speed (0-100.0%).
- RPM** is the actual revolutions per minute of the motor.
- Run** shows whether the pump motor is running or stopped.
- Fault** is the fault status of the VFD/DEPM motor and can either be Ok or Fault.
- Hand Auto** is the current auto status of the VFD/ECM drive and can either be Auto or Hand.
- Lead** is displayed as Lead, Lag1 to Lag4, or Standby
- Mode** is either Hand, Off, or Auto.
- The **Message** of **Modbus Communication** is the current Modbus communication status between PLC and VFD/ECM drive. It can either be: Invalid Request / Timeout / Ok / Illegal Faction / Illegal Address / Illegal Value / Slave Failure / Acknowledge / Slave Busy.
- The **Alarm** of **Modbus Communication** is the current Modbus communication alarm status of the VFD/DEPM motor and can be Ok or Fault.
- The Suction Pressure is displayed.
- The Boost Pressure is displayed.
- The Setpoint (System Discharge Pressure) is displayed.
- The Active SP (Active Discharge Setpoint) is displayed.
- The (Local) Discharge Pressure is displayed.
- The Remote Discharge Pressure is displayed if the remote sensor is enabled.

1.1.7 COMMISSION SCREEN

COMMISSION	
Disables:	
1) No Flow shutdown.	
2) Pressure setback mode:	
Active for 24 hours.	Commission mode off

MAIN MENU	SYSTEM OVERVIEW	SERVICE
-----------	-----------------	---------

- Where if **Commission mode off/on** switch is in **Commission mode on** position it disables the no flow shutdown and the pressure setback mode. The commission mode is active for only 24 hours. The commission mode is used for testing an ivs Booster system in case of not occupy building with no flow in it.

1.1.8 ENERGY SCREEN

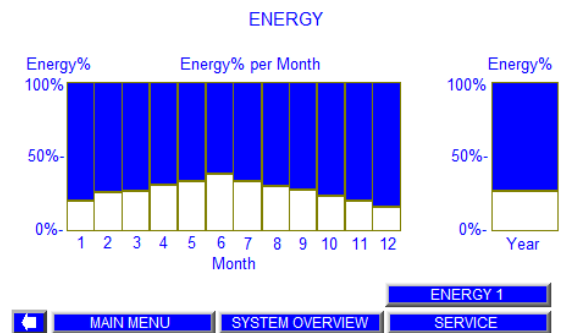

- 1 The **Energy** screen displays graphical the energy used every month throughout the year.
- 2 Pressing **Energy 1** displays the energy usage is more details.

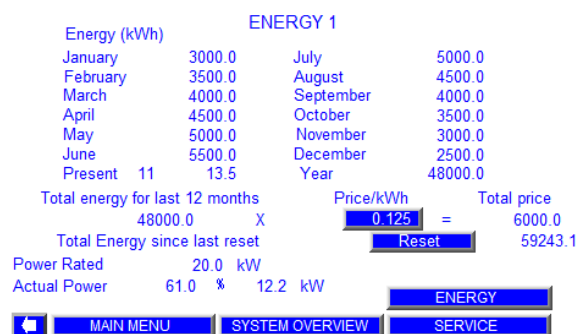

- 3 The **Price/kWh** can be changed.
- 4 The **Reset** button to clear all previous data and restart tracking.

1.1.9 FLOW SCREEN

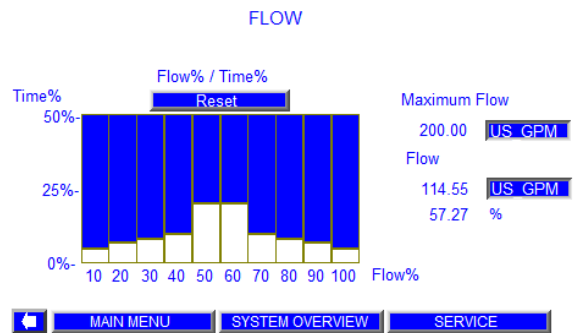

- 1 Flow % is tracked as a per time operated
- 2 The **Reset** button to clear all previous data and restart tracking.

1.2 ALARM MANAGEMENT SCREENS

See the following table

1.2.1 ALARMS SCREEN

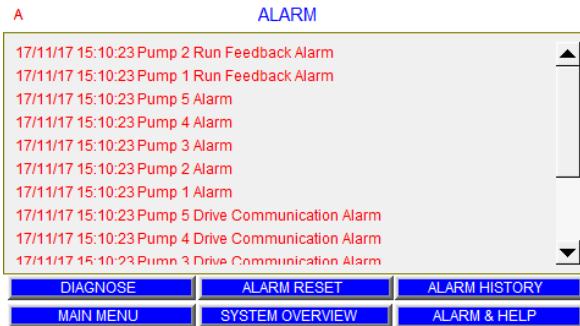

- 1 All alarms will be displayed in chronological order.
- 2 The last alarm will be at the top of the screen.
- 3 Press **diagnose** to pop up the PLC DIAGNOSTIC box.
- 4 Press **alarm reset** to reset all active alarms.
- 5 Press the up and down arrow buttons to view more alarms.
- 6 Press the **alarm & help** button to bring up the Alarm and Help screen.
- 7 Press the **alarm history** button to bring up the Alarm History screen.
- 8 Press the buttons on the menu at the bottom to bring up the desired screen.

1.2.2 ALARM & HELP SCREEN

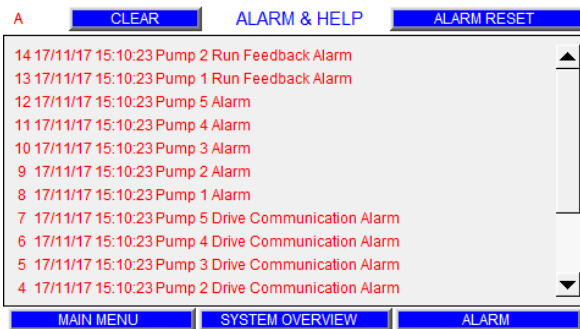

- 1 The alarms saved in the internal memory of the HMI are displayed.
- 2 Pressing the alarm displayed will bring up the Alarm Information screen.
- 3 Press the **clear** and history of alarms in the internal memory of the HMI will be cleared.
- 4 Press ALARM RESET to clear the current alarm and enable the booster to restart.
- 5 Press the up and down arrow buttons to view more alarms.
- 6 Press the buttons on the menu at the bottom to bring up the desired screen.

1.2.3 ALARM INFORMATION SCREEN

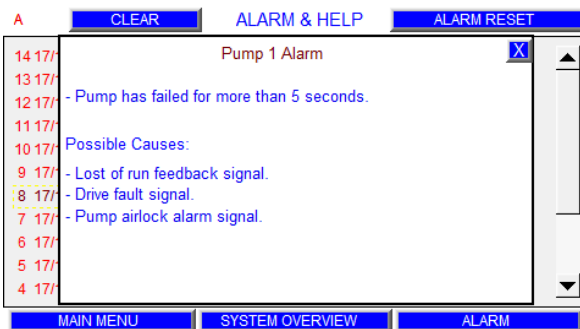

- 1 Press any alarm in Alarm & Help screen will pop up a corresponding alarm information box.
- 2 The alarm description, the possible cause of alarm and the remedy for this alarm will be displayed in the alarm information box.
- 3 Press the upper right cross button to close this box.

1.2.4 ALARM HISTORY SCREEN

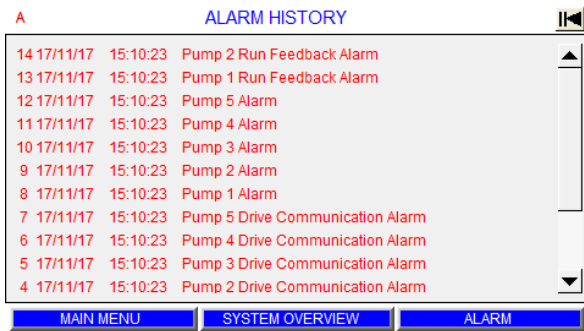

- 1 The history alarms saved in the internal memory of the HMI are displayed.
- 2 Press the top-right button (black arrow) to select the history alarm to display. The selected number indicates the number of days before today. The history alarms will be displayed for that day.
- 3 Press the up and down arrow buttons to view more alarms.
- 4 Press the left and right arrow buttons to view more content of alarms.
- 5 Press the buttons on the menu at the bottom to bring up the desired screen.

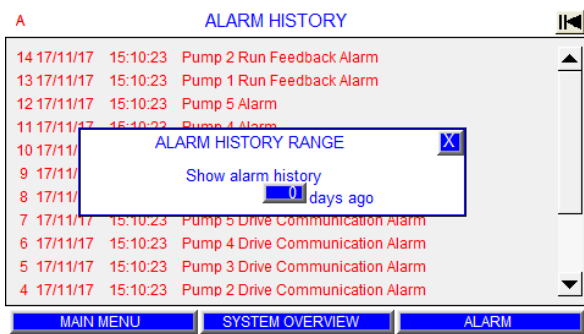

1.3 LEVEL 0 SETUP SCREENS

See the following table

1.3.0 LEVEL 0 SETUP MENU

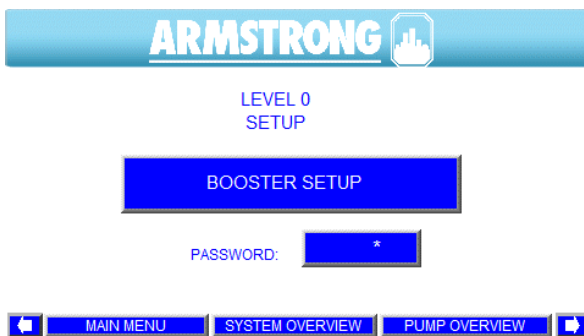

- 1 Touching the **setup** button from **Main Menu** will call up the Level 0 Setup screen.
- 2 Pressing the password area will pop-up a keypad to log on to installer screens or factory screens.
- 3 The top left corner of the screen will flash **A** when there is a new alarm. The **A** will be solid when the alarm is acknowledged or muted. Pressing the **A** will call up the alarm screen.
- 4 Pressing the **booster setup** button will call up its the first Setup display.
- 5 Touching the **Right** and **Left** arrow will navigate between the viewing only Setup Screens
- 6 These screens are for viewing only. No values can be modified on these screens.
- 7 Below are the screens that the user sees when pressing on each of those buttons.
- 8 Touch the buttons on the menu at the bottom to bring up the desired screen.

1.3.1 BOOSTER SETUP

BOOSTER SETUP

Number of Pumps:

Standby Pump:

Level Switch 1:

Level Switch 2:

Drive Type:

Motor Frequency:

Lead Pump Switch Time: Hours

Pump Rated Power: kW

Default Settings:

SETUP
iECM

1: Drive Type: HPI 1.0/71, HPI 2:0

2: Drive Type: HPI 1.0/71, HPI 2:0

FOR VIEWING ONLY

1.3.2 SENSOR SETUP

SENSOR SETUP

	Zero	Range	Unit	Enable
Suction Sensor:	0.0 ~	<input type="text" value="300.00"/>	<input type="text" value="psi"/>	<input type="text" value="Yes"/>
Discharge Sensor:	0.0 ~	<input type="text" value="300.00"/>	<input type="text" value="psi"/>	<input type="text" value="Yes"/>
Remote Discharge Sensor:	0.0 ~	<input type="text" value="300.00"/>	<input type="text" value="psi"/>	<input type="text" value="No"/>
Booster Stop if Suction Sensor Fail:				<input type="text" value="No"/>

FOR VIEWING ONLY

1.3.3 PRESSURE SETUP

DISCHARGE PRESSURE SETUP

Local Setpoint: psi

Remote Setpoint: psi

Choose control sensor:

FOR VIEWING ONLY

ALTERNATE DISCHARGE PRESSURE SETUP

1.3.4 PRESSURE LIMIT SETUP 1

PRESSURE LIMIT SETUP 1

High suction pressure: psi

Low suction pressure: psi

High discharge pressure: psi

High Alarm Delay: sec

High Alarm Reset:

Low discharge pressure: psi

FOR VIEWING ONLY

1.3.5 PRESSURE LIMIT SETUP 2

PRESSURE LIMIT SETUP 2

EMERGENCY POWER MODE

Number of running pumps in emergency:

Emergency Low Discharge: psi

FACTORY SETUP

Factory high discharge: psi

FOR VIEWING ONLY

1.3.6 PROTECTION SETUP

PROTECTION SETUP

END OF CURVE

EOC Head: %

AQUASTAT SHUTDOWN

AIRLOCK PUMP SHUTDOWN

Power setpoint: %

Delay: sec

FOR VIEWING ONLY

1.3.7 PUMP STAGING SETUP

PUMP STAGING SETUP

Stage on speed: %

Stage off by:

Stage off speed: %

Stage off power: %

Stage on delay: sec

Stage off delay: sec

FOR VIEWING ONLY

1.3.8 SOFT FILL SETUP

SOFT FILL SETUP

Enabled

Start setpoint: %

Run setpoint: %

Ramp: sec

FOR VIEWING ONLY

1.3.12 PRESSURE SETBACK SETUP

PRESSURE SETBACK SETUP

Enabled

Setpoint: %

Control mode:

FOR VIEWING ONLY

1.3.9 NO FLOW SHUTDOWN SETUP

NO FLOW SHUTDOWN SETUP

Enabled

Delay: sec

Set Speed/Power: %

Wait time: sec

Boost pressure: psi

FOR VIEWING ONLY

1.3.13 BAS SETUP

BAS SETUP

Protocol:

Address:

Baud Rate:

FOR VIEWING ONLY

1.3.10 SPEED SETUP

SPEED SETUP

Minimum: %

Maximum: %

Start Speed: %

Default speed: %

Motor Rated RPM: RPM

FOR VIEWING ONLY

1.3.14 FIELDBUS SETUP

FIELDBUS SETUP

Source:

Protocol:

Baud Rate:

Parity:

Stop Bit:

Pump Address:

FOR VIEWING ONLY

1.3.11 PID SETUP

PID SETUP

Gain: %/sec

Speed Up Limit: %/sec

Speed Down Limit: %/sec

POWER LIMIT SETUP

Motor Power Limit:

Power Limit Speed Reduction: %

PUMP ALARM AUTO RESET

Delay: %/sec

Delay: sec

FOR VIEWING ONLY

1.3.15 FLOW SETUP

FLOW SETUP

Pump Model:

Design Flow: US GPM

Flow Unit:

Flow Offset:

FOR VIEWING ONLY

1.3.16 CLOCK SETUP

CLOCK SETUP

Real Time Clock	Time HH:MM:SS	Date MM/DD/YYYY
HMI Time:	16 : 8 : 30	11 / 14 / 2017
PLC Time:	16 : 8 : 5	11 / 14 / 2017

FOR VIEWING ONLY



1.3.17 ALTERNATE DISCHARGE PRESSURE SETUP

ALTERNATE DISCHARGE PRESSURE SETUP

Number of Setpoints (0-6):

FOR VIEWING ONLY

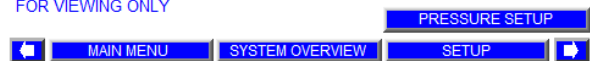

2.0 INSTALLER SCREENS

Installer Screens include operation screens, alarm management screens, and level 1 setup screens. To access level 1 setup screens the user is required a level 1 password.

2.1 LEVEL 1 SETUP SCREENS

Most of the level 1 setup screens are almost the same as the level 0 setup screens, except that the user can touch buttons and input areas to change the parameter, press **Restore All Default Settings** button to restore changed values to the system factory defaults on each setup display screen.

2.1.0 LEVEL 1 SETUP MENU



- 1 Pressing and inputting the proper password in **Level 0 Setup** screen will call up the Level 1 Setup screen.
- 2 The top left corner of the screen will flash **A** when there is a new alarm. The **A** will be solid when the alarm is acknowledged or muted. Pressing the **A** will call up the alarm screen.
- 3 Pressing the **Booster Setup** button will call up its the first Setup display.
- 4 Touching the **Right** and **Left** arrow will navigate between Level 1 Setup Screens
- 5 PID Setup screen is for viewing only.
- 6 After changing values in any setup screens, should you want to go back to the factory default values, press the **Restore** button.
- 7 Below are the screens that the user sees when pressing on each of those buttons.
- 8 Touch the buttons on the menu at the bottom to bring up the desired screen

2.1.1 BOOSTER SETUP

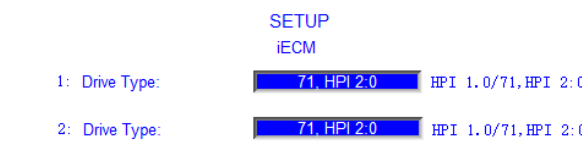
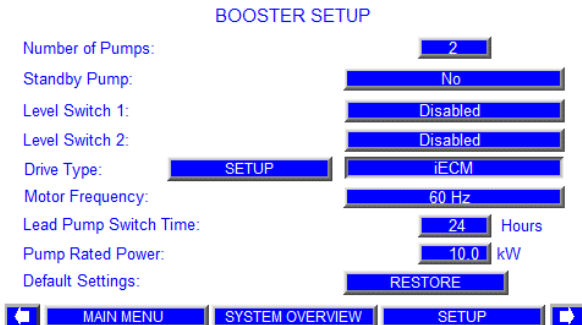

FOR VIEWING ONLY

- 1 Touching the button beside the description of **Number of Pumps** will allow to enter between 1 to 5 pumps.
- 2 Touching the button beside the description of **Standby Pump** will toggle between **No** and **Yes**.
- 3 Touching the button beside the description of **Level Switch 1** will toggle between **Enabled** and **Disabled**.
- 4 Touching the button beside the description of **Level Switch 2** will toggle between **Enabled** and **Disabled**.
- 5 Touching the button beside the description of **Drive Type** will toggle between **FC 102 , FC101** and **iECM**.
- 6 Touching the setup iECM button to bring up the **iECM** drive (1-5) type setting screen.
- 7 Touching the bar button beside the description of **Drive Frequency** will toggle between 60 Hz and 50 Hz.
- 8 Enter the lead pump switch time. After the lead pump runs for the entered number of hours, the lag1 or standby pump will switch to lead.
- 9 Enter the pump rated power as indicated on the motor nameplate.
- 10 Press the **Restore** button to retrieve booster setup values from the system factory defaults.
- 11 Touch the buttons on the menu at the bottom to bring up the desired screen.

2.1.2 SENSOR SETUP

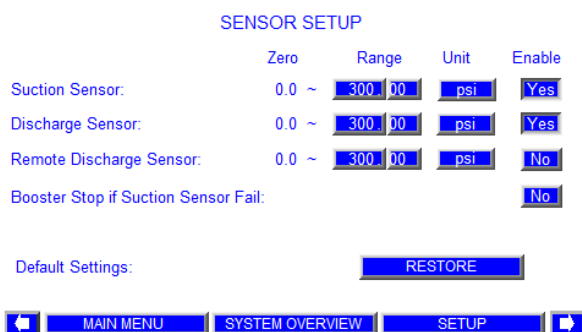

- 1 From **Level 1 Main Setup** toggle left or right to call up this screen.
- 2 Press the first box in column 1 to enter the range for the system suction pressure sensor.
- 3 Press the second box in column 1 to enter the range for system discharge pressure sensor.
- 4 Press the third box in column 1 to enter the range for system remote pressure sensor.
- 5 Press any box in column 2 to toggle the pressure unit among **psi, ft, KPa, m** and **bar**.
- 6 Press the first box in column 3 to enable or disable the system suction pressure sensor.
- 7 Press the second box in column 3 to enable or disable the system discharge pressure sensor.
- 8 Press the third box in column 3 to enable or disable system remote pressure sensor.
- 9 Press **Yes** or **No** for **Booster Stop if Suction Sensor fails**
- 10 Press **Restore** button to retrieve sensor setup values from the system factory defaults.
- 11 Touch the buttons on the menu at the bottom to bring up the desired screen.

2.1.3 PRESSURE SETUP

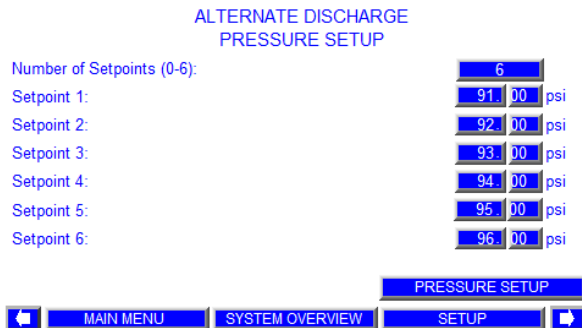
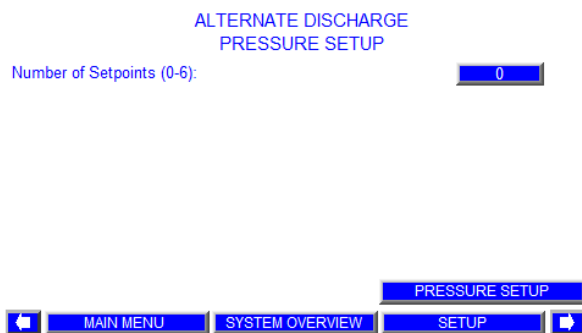
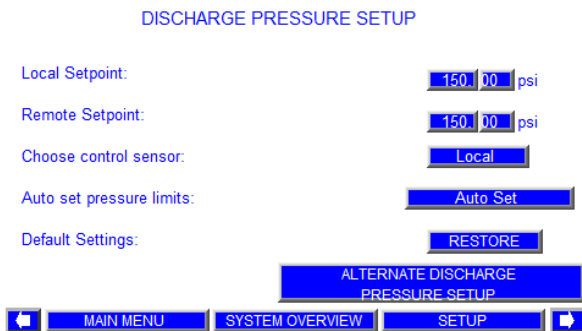

- 1 From **Level 1 Main Setup** toggle left or right to call up this screen.
- 2 Enter the local discharge pressure setpoint or local system pressure setpoint in the box beside the **Local Setpoint**.
- 3 Enter the remote discharge pressure setpoint in the box beside the **Remote Setpoint**.
- 4 Pressing the button beside the description of **Choose control sensor** will toggle between **Local** and **Remote**. If **Local** is selected, the discharge pressure sensor will be the control sensor. If **Remote** is selected, the remote pressure sensor will be the control sensor.
- 5 After input the setpoints, press **Auto set** button to automatically update the High and Low pressure limits for the discharge and suction pressure according to the pressure setpoint entered.
- 6 Press the **Restore** button to retrieve pressure setup values from the system factory defaults.
- 7 Touching the **Alternate Discharge Pressure Setup** button to call up the Alternate Discharge Pressure Setup screen.
- 8 Enter the Number of Setpoints. System Discharge Pressure Setpoints will popup accordingly.
- 9 Enter the Setpoint in the corresponding box beside the description. If an Alternate Setpoint Switch from 1 to 6 is closed, then the corresponding Alternate Discharge Pressure Setpoint is used instead of Local or Remote Pressure Setpoint.
- 10 Touch the buttons on the menu at the bottom to bring up the desired screen.

2.1.4 PRESSURE LIMIT SETUP 1

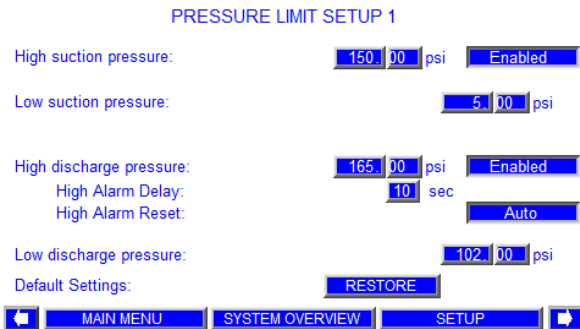

- 1 From **Level 1 Main Setup** toggle left or right to call up this screen.
- 2 Enter high suction pressure alarm/shutdown limit by pressing the left box beside the description. By pressing the right box, this function can be enabled or disabled.
- 3 Enter low suction pressure alarm/shutdown limit by pressing the box beside the description (Enter zero for disabling it).
- 4 Enter high discharge pressure alarm/shutdown limit by pressing the left box beside the description. By pressing the right box, this function can be enabled or disabled.
- 5 Enter the High Alarm Delay by pressing the left box beside it. If the High discharge pressure setpoint is exceeded for more than the High Alarm Delay time, a alarm is given.
- 6 High Alarm reset can be set in Auto or Manual Mode. In Auto mode, if at anytime, the pressure falls 5psi below the High discharge pressure setpoint, the alarm will be disabled. In Manual mode, the Alarm must be manually reset to restart the booster.
- 7 Enter low discharge pressure alarm/shutdown limit in normal mode by pressing the box beside the description (Enter zero for disabling it).
- 8 Press **Restore** button to retrieve pressure limit setup values from the system factory defaults.
- 9 Touch the buttons on the menu at the bottom to bring up the desired screen

2.1.5 PRESSURE LIMIT SETUP 2

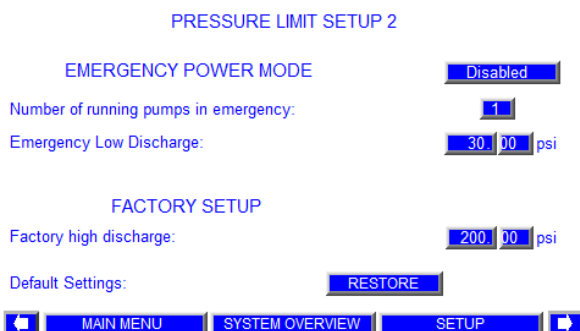

- 1 Emergency power mode can be enabled or disabled here by pressing the box beside the description. If it's enabled, when Emergency Power occurs, the **Number of running pumps in emergency** is designated to operate. The regular **Low discharge pressure** value will be disabled and the **Emergency Low Discharge** pressure value will apply
- 2 Enter the Number of Pumps in Emergency power mode. Default is 1
- 3 Enter low discharge pressure alarm/shutdown limit in emergency power mode by pressing the box beside the description.
- 4 Factory high discharge pressure alarm / shutdown limit is displayed.
- 5 Press **Restore** button to retrieve pressure limit setup values from the system factory defaults.
- 6 Touch the buttons on the menu at the bottom to bring up the desired screen.

2.1.6 STAGING SETUP

PUMP STAGING SETUP

Stage on speed: %

Stage off by:

Stage off speed: %

Stage off power: %

Stage on delay: sec

Stage off delay: sec

Default Settings:

- 1 From **Level 1 Main Setup** toggle left or right to call up this screen.
- 2 Enter pump Stage on speed for all the Lag pumps in the boxes beside the description. When the speed of lead pump reaches the corresponding speed entered above for a time as specified in Stage on delay, the next lag pump will be staged up.
- 3 Press the pump Stage off by selector box to toggle between **Speed, Power, Speed or Power** and **Speed and Power**. Default is **Speed or Power**.
- 4 Enter pump Stage off speed for all the lag pumps beside the description.
- 5 Enter pump Stage off power for all the lag pumps beside the description.
- 6 The program switches off a pump, after the Stage Off Delay time if the pumps speed is less than the Stage Off Speed and/or disconnection of one pump will cause the remaining pump(s) power to be less than the Pump(s) Stage Off Power. The speed or power condition also can be disabled. (The stage off selector settings: Speed, Power, Speed or Power, Speed and Power.)
- 7 Enter the delay time for staging on and staging off in the Stage off delay field.
- 8 The **Restore** button retrieves staging setup values from the system factory defaults, only if needed.
- 9 Touch the buttons on the menu at the bottom to bring up the desired screen.

2.1.7 SOFT FILL SETUP

SOFT FILL SETUP

Start setpoint: %

Run setpoint: %

Ramp: sec

Default Settings:

- 1 From **Level 1 Main Setup** toggle left or right to call up this screen.
- 2 Soft Fill mode can be enabled or disabled by pressing the box beside the description. When the booster is powered up, the lead pump starts. The System Discharge Pressure Setpoint increases in a linear ramp, starting at the Soft Fill Start Pressure Setpoint or Discharge Pressure Setpoint (whichever is higher) at a rate of (Discharge Pressure Setpoint - Soft Fill Start Pressure Setpoint) / Soft Fill Ramp Time, until the pressure reaches the System Pressure Setpoint or the Pressure Setback Setpoint (if Pressure Setback Mode is enabled), then the booster switches to Normal Mode. Soft Fill also starts at any point during normal operation, if the pressure drops down to or below Soft Fill Run Setpoint value.
- 3 Enter Soft Fill Start Setpoint percent in the box beside the description. This is a percent of Discharge Pressure Setpoint.
- 4 Enter Soft Fill Run Setpoint percent in the box beside the description. This is a percent of Discharge Pressure Setpoint.
- 5 Enter soft fill ramp time in the box beside the description.
- 6 The Restore button retrieves soft fill setup values from the system factory defaults, only if needed.
- 7 Touch the buttons on the menu at the bottom to bring up the desired screen.

2.1.8 NO FLOW SHUTDOWN SETUP

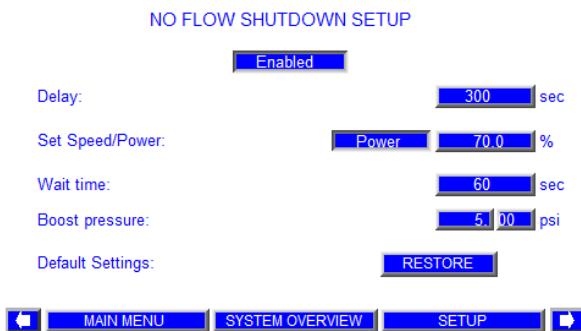

- 1 From **Level 1 Main Setup** toggle left or right to call up this screen.
- 2 No flow shutdown can be enabled or disabled by pressing the box beside the description. This feature allows the booster to be shutdown when there is no flow demand.
- 3 Enter the no flow shutdown delay in the box beside the description. This is the delay time to check if the discharge pressure changes less than 2psi or equivalent (no flow condition) after the power/speed of lead pump is lower than **Lead pump No Flow shutdown power/speed setpoint** entered in the Set Speed/Power field.
- 4 Enter Lead pump No Flow shutdown power/speed setpoint in the box beside the Set Speed/Power. This is the pump power/speed when only lead pump is running to start to check the no flow condition.
- 5 Enter the No Flow shutdown wait time in the box beside the Wait time description. This is the wait time to check if the discharge pressure changes less than 2psi or equivalent (no flow confirmation) after the speed of lead pump is reduced 5% when the power/speed condition is met.
- 6 Enter No Flow boost pressure in the box beside the Boost Pressure description. This is added pressure to the pressure setpoint for 2 minutes before the booster is shutdown. After the booster is shutdown, the lead pump should be started when the discharge pressure drops 5psi or equivalent below the pressure setpoint.
- 7 The **Restore** button retrieves no flow shutdown setup values from the system factory defaults, only if needed.
- 8 Touch the buttons on the menu at the bottom to bring up the desired screen.

2.1.9 SPEED SETUP

SPEED SETUP

Minimum: %

Maximum: %

Start Speed: %

Default speed: %

Motor Rated RPM: RPM

Default Settings:

- 1 Enter the minimum pump speed setpoint in the box beside the description.
- 2 Enter the maximum pump speed setpoint in the box beside the description.
- 3 Enter the start pump speed setpoint in the box beside the description.
- 4 Enter the default pump speed setpoint in the box beside the description. This is the default pump speed when the discharge pressure sensor fails and the aquastat sensor (enabled) is closed.
- 5 Enter the rated rpm pump setpoint in the box beside the description.
- 6 The Restore button retrieves speed setup values from the system factory defaults, only if needed.
- 7 Touch the buttons on the menu at the bottom to bring up the desired screen.

2.1.10 PID SETUP

PID SETUP

Gain: %/sec

Speed Up Limit: %/sec

Speed Down Limit: %/sec

POWER LIMIT SETUP

Motor Power Limit: %

Power Limit Speed Reduction: %/sec

PUMP ALARM AUTO RESET

Delay: sec

FOR VIEWING ONLY

This screen is for viewing only

- 1 From **Level 1 Main Setup** toggle left or right to call up this screen. The screen is for viewing only.
- 2 Touch the buttons on the menu at the bottom to bring up the desired screen.

2.1.11 PRESSURE SETBACK SETUP

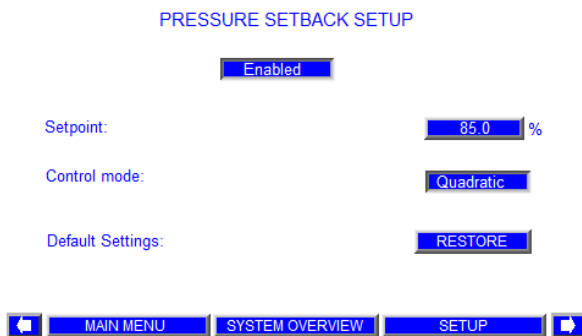

- 1 From **Level 1 Main Setup** toggle left or right to call up this screen.
- 2 Pressure setback mode can be enabled or disabled by pressing the box beside the description
- 3 Enter the pressure setback setpoint in the box beside the Setpoint description. This is a percentage of the system pressure setpoint. This feature will decrease the system pressure setpoint relative to the pumps' power. When the pumps consume no power, the pressure setpoint reduces to this percent value. When all the pumps run at their rated power, the pressure setpoint is the value inputted in the pressure setup screen. The pressure setpoint will increase linearly or quadratically from this percent value to 100% when the pumps' power increase from 0 to the total rated power.
- 4 Press the button beside the Control Mode description to toggle between **Linear** and **Quadratic**. It enables Linear or Quadratic pressure control for pressure setback function.
- 5 The **Restore** button retrieves pressure setback setup values from the system factory defaults, only if needed.
- 6 Touch the buttons on the menu at the bottom to bring up the desired screen.

2.1.12 PROTECTION SETUP

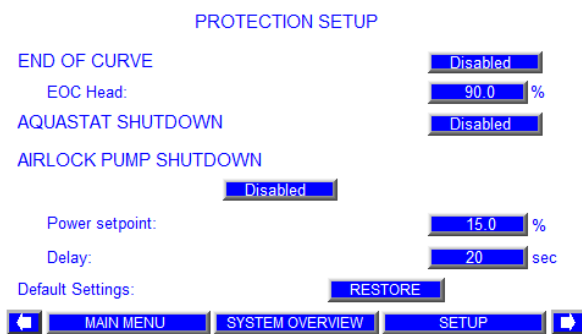

- 1 From **Level 1 Main Setup** toggle left or right to call up this screen.
- 2 End of Curve protection can be enabled or disabled by pressing the box beside the description.
- 3 Enter the End of Curve Head (EOC Head). This is the full speed EOC head in percent of design head.
- 4 If an Aquastat switch is installed then Aquastat protection can be enabled or disabled by pressing the box beside the description. All pumps will stop running if the aquastat switch is open and the Aquastat alarm message will be displayed.
- 5 Airlock pump shutdown protection can be enabled or disabled by pressing the box beside the description.
- 6 Enter airlock shutdown power setpoint (percent of nominal power) in the box beside the description. When any pump speed is faster than 50% and the power it consumes is less than the airlock power shutdown setpoint (factory set to what the pump consumes running at Minimum Speed with no flow) for longer than the airlock shutdown delay time. The pump/drive will be tagged as 'failed'. The alarm message will indicate which pump triggered the alarm.
- 7 Enter airlock shutdown delay time in the box beside the delay description.
- 8 The **Restore** button retrieves airlock setup values from the system factory defaults, only if needed.
- 9 Touch the buttons on the menu at the bottom to bring up the desired screen.

2.1.13 BAS SETUP

BAS SETUP

Protocol: Modbus

Address: 1

Baud Rate: 19200

Setup Modbus Baud Rate: 19200

Default Settings: RESTORE

MAIN MENU
SYSTEM OVERVIEW
SETUP

- 1 From **Level 1 Main Setup** toggle left or right to call up this screen.
- 2 Select the BAS Protocol (N/A, Modbus, LonWorks, Metasys, and Bacnet).
- 3 Enter the BAS address.
- 4 Enter the BAS Baud Rate.
- 5 The **Restore** button retrieves BAS setup values from the system factory defaults, only if needed.
- 6 Touch the buttons on the menu at the bottom to bring up the desired screen.

2.1.14 FIELDBUS SETUP

FIELDBUS SETUP

Source: Fbus2

Protocol: Modbus RTU

Baud Rate: 19200

Parity: No Parity

Stop Bit: 1

Pump Address: P1=1,P2=2,P3=3,P4=4,P5=5

FOR VIEWING ONLY

MAIN MENU
SYSTEM OVERVIEW
SETUP

This screen is for viewing only

- 1 From **Level 1 Main Setup** toggle left or right to call up this screen. The screen is for viewing only.
- 2 Touch the buttons on the menu at the bottom to bring up the desired screen.

2.1.15 CLOCK SETUP

CLOCK SETUP

Real Time Clock	Time HH:MM:SS	Date MM/DD/YYYY
HMI Time:	15 : 52 : 39	11 / 14 / 2017
PLC Time:	15 : 52 : 14	11 / 14 / 2017
Set PLC	0 : 0 : 00	0 / 0 / 20 0

MAIN MENU
SYSTEM OVERVIEW
SETUP

- 1 From **Level 1 Main Setup** toggle left or right to call up this screen to adjust the time in the HMI and display the time in the PLC.
- 2 The HMI time and date can be adjusted by pressing the individual hour, minute, second, month, day, and year box and entering the corresponding value.
- 3 Touch the buttons on the menu at the bottom to bring up the desired screen.

3.0 FACTORY SCREENS

Factory Screens include operation screens, alarm management screens, and level 2 setup screens. To access level 2 setup screens a level 2 password is required.

3.1 OPERATION SCREENS

See above in the Operator Screens, section 1.1.

3.2 ALARM MANAGEMENT SCREENS

See previously in the Operator Screens, section 1.2.

3.3 LEVEL 2 SETUP SCREENS

Most of the level 2 setup screens are almost the same as the level 1 setup screens, except that the user can press **Save** button to save changed values to the system factory defaults on each setup display screen. However, some different screens are listed in the following table.

3.3.0 LEVEL 2 SETUP MENU

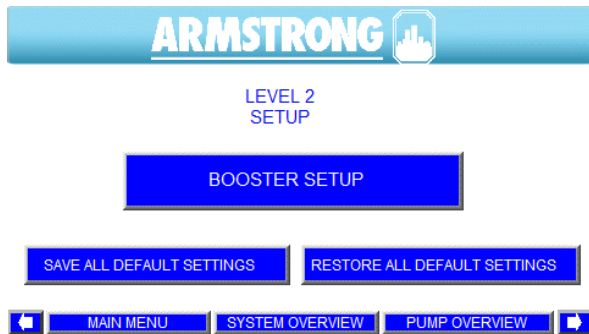

- 1 Pressing and inputting the proper password in **Level 0 Setup** screen will call up the Level 2 Setup screen.
- 2 The top left corner of the screen will flash **A** when there is a new alarm. The **A** will be solid when the alarm is acknowledged or muted. Pressing the **A** will call up the alarm screen.
- 3 Pressing the **Booster Setup** button will call up its the first Setup display.
- 4 Touching the **Right** and **Left** arrow will navigate between Level 2 Setup Screens
- 5 After changing values in any setup screens, press **Save** button to save all the changes as system factory defaults. Important reminder: Step 5 must be executed after initial setup in order for the Restore function to work properly. Otherwise restore will setup all variables to improper values!!!
- 6 After changing values in any setup screens, should you want to go back to the factory default values, press the **Restore** button.
- 7 Below are the screens that the user sees when pressing on each of those buttons.
- 8 Touch the buttons on the menu at the bottom to bring up the desired screen.

3.3.1 PRESSURE LIMIT SETUP

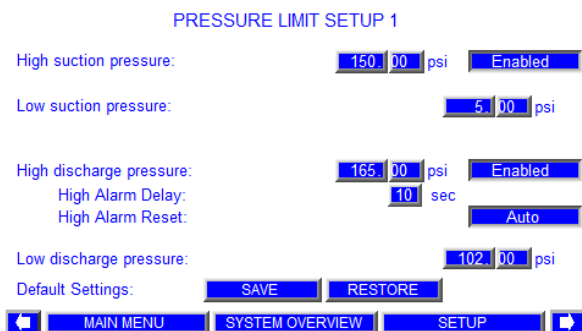

- 1 From **Level 2 Main Setup** toggle left or right to call up this screen.
- 2 Enter high suction pressure alarm/shutdown limit by pressing the left box beside the description. By pressing the right box, this function can be enabled or disabled.
- 3 Enter low suction pressure alarm/shutdown limit by pressing the box beside the description (Enter zero for disabling it).
- 4 Enter high discharge pressure alarm/shutdown limit by pressing the left box beside the description. By pressing the right box, this function can be enabled or disabled.
- 5 Enter the High Alarm Delay by pressing the left box beside it. If the High discharge pressure setpoint is exceeded for more than the High Alarm Delay time, a alarm is given.
- 6 High Alarm reset can be set in Auto or Manual Mode. In Auto mode, if at anytime, the pressure falls 5psi below the High discharge pressure setpoint, the alarm will be disabled. In Manual mode, the Alarm must be manually reset to restart the booster.
- 7 Enter low discharge pressure alarm/shutdown limit in normal mode by pressing the box beside the description(Enter zero for disabling it).
- 8 Press **Restore** button to retrieve pressure limit setup values from the system factory defaults.
- 9 Touch the buttons on the menu at the bottom to bring up the desired screen.

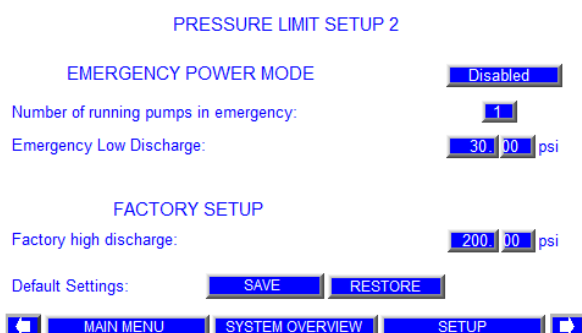

- 1 From **Level 2 Main Setup** toggle left or right to call up this screen.
- 2 Emergency power mode can be enabled or disabled here by pressing the box beside the description. If it's enabled, when Emergency Power occurs, the **Number of running pumps in emergency** is designated to operate. The regular **Low discharge pressure** value will be disabled and the **Emergency Low Discharge** pressure value will apply
- 3 Enter the Number of Pumps in Emergency power mode. Default is 1
- 4 Enter low discharge pressure alarm/shutdown limit in emergency power mode by pressing the box beside the description.
- 5 Enter factory high discharge pressure alarm / shutdown limit.
- 6 Press **Restore** button to retrieve pressure limit setup values from the system factory defaults.
- 7 Touch the buttons on the menu at the bottom to bring up the desired screen.

3.3.2 PID SETUP

PID SETUP

Gain: 10 %/sec

Speed Up Limit: 1.0 %/sec

Speed Down Limit: 3.0 %/sec

POWER LIMIT SETUP: Disabled

Motor Power Limit: 103.0 %

Power Limit Speed Reduction: 0.5 %/sec

PUMP ALARM AUTO RESET: Disabled

Delay: 900 sec

Default Settings: SAVE RESTORE

MAIN MENU SYSTEM OVERVIEW SETUP

- 1 From **Level 2 Main Setup** toggle left or right to call up this screen.
- 2 Enter the proportional gain in the box beside the description. Increasing the Gain increases the reaction speed to discharge pressure changes. Decreasing the value slows down the reaction speed to a discharge pressure deviations from setpoint.
- 3 Enter the speed up limit in the box beside the description.
- 4 Enter the speed down limit in the box beside the description.
- 5 The ramp time in the PLC and the drives should always be 15sec. That allows the actual ramp up time to be controlled by the PID Speed Up and Speed Down Limits. If the Speed Up Limit = 1.0% , Max Speed =100%, Min Speed=40% then the actual ramp up time = (Max Speed- Min Speed) /Speed Up Limit = 60sec.
- 6 Example for PID parameters and speed relationship: If Disch Press deviation from setpoint = 15.0 PSI, Gain=10%/sec and Current speed=58.0%, then Updated Pumps Speed= Current speed + Disch Press deviation* Gain = 58.0% + 15.0 * 10/100 = 58.0% + 1.5% = 59.5% But the pumps acceleration rate is limited by the Speed Up Limit, so if the Speed Up Limit = 1% then the updated speed is 58.0% + minimum (1.0%, 1.5%) = 59.0% instead of 59.5%. The pump speed update is done once per second.
- 7 Power Limit Mode can be enabled or disabled here by pressing the box beside the description. Default is disabled. If it's enabled, when any Pump Motor Power is greater than the Motor Power limit setpoint, the booster auto speed is reduced for the Power Limit Speed Reduction Setpoint.
- 8 Enter the Motor Power Limit Setpoint. Default is 103 %.
- 9 Enter the Power Limit Speed Reduction Setpoint. Default is 0.5 %/sec.
- 10 Pump Alarm Auto Reset Mode can be enabled or disabled. Default is disabled. If it's enabled, when any Pump Drive has fault (except a communication fault) than only the Pump Drive effected will be reset after (default is 900 sec) adjustable delay time.
- 11 Enter the Pump Alarm Auto Reset Delay Time. Default is 900 sec.
- 12 Touch the buttons on the menu at the bottom to bring up the desired screen.

3.3.3 FIELDBUS SETUP

FIELDBUS SETUP

Source: Fbus2

Protocol: Modbus RTU

Baud Rate: 19200

Parity: No Parity

Stop Bit: 1

Pump Address: P1=1,P2=2,P3=3,P4=4,P5=5

Default Settings: SAVE RESTORE

MAIN MENU SYSTEM OVERVIEW SETUP

- 1 From **Level 2 Main Setup** toggle left or right to call up this screen.
- 2 Select the FieldBus card if the card exists. Default FieldBus connection is FBus2.
- 3 The factory default Protocol, Baud rate , Parity Mode and Stop Bit, and Pump Address are read only as displayed.
- 4 Press **Save** button to save changed values to the system factory defaults, press **Restore** button to retrieve setup value from the system factory defaults.
- 5 Touch the buttons on the menu at the bottom to bring up the desired screen.

3.3.4 CLOCK SETUP

CLOCK SETUP

Real Time Clock	Time HH:MM:SS	Date MM/DD/YYYY
HMI Time:	15 : 44 : 45	11 / 14 / 2017
PLC Time:	15 : 44 : 20	11 / 14 / 2017
Set PLC	0 : 0 : 00	0 / 0 / 20 0



- 1 From **Level 2 Main Setup** toggle left or right to call up this screen to adjust the time in the HMI and the time in the PLC.
- 2 The HMI time and date can be adjusted by pressing the individual hour, minute, second, month, day, and year box and entering the corresponding value.
- 3 The system (PLC) time and date can be adjusted by pressing the individual hour, minute, month, day, and year box and entering the corresponding value.
- 4 Press **Set PLC** button to write the displayed time and date to the system.
- 5 Touch the buttons on the menu at the bottom to bring up the desired screen.

4.0 SYSTEM START-UP PROCEDURE

- 1 Ensure the power supply to the booster panel
- 2 Turn on the main power disconnect on the door of the booster panel
- 3 Press the button indicated as **Remote Start** and the button will show as **Local Start**. The Booster will turn on indicated by the **Booster On**.
- 4 Press **Pump Overview** to open the Pump Overview screen
- 5 The screen changes to **Pump Overview**. Press **Pump 1** button.

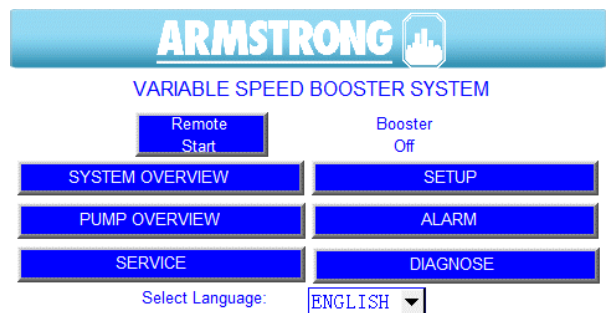

PUMP OVERVIEW

	PUMP 1	PUMP 2
Mode	Auto	Auto
Lead	Lag1	Lead
Run	Run	Run
Speed	88.2 % 3175 RPM	88.2 % 3175 RPM
RunHrs	0045	0045
Alarm	OK	OK

Discharge Pressure: 150.0 psi Lead Switch in: 2 Hrs

MAIN MENU SYSTEM OVERVIEW ALARM

- 6 **Pump 1 Control** is popped up. Press **Auto** button. Close the window by touching the **X** button, the screen changes to **Pump Overview** again.
- 7 Repeat step 6 for all other corresponding pumps.
- 8 The booster will start up automatically

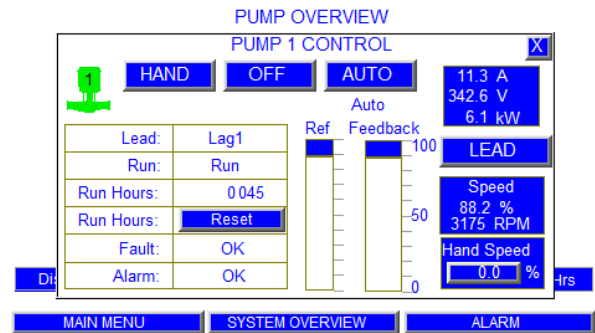

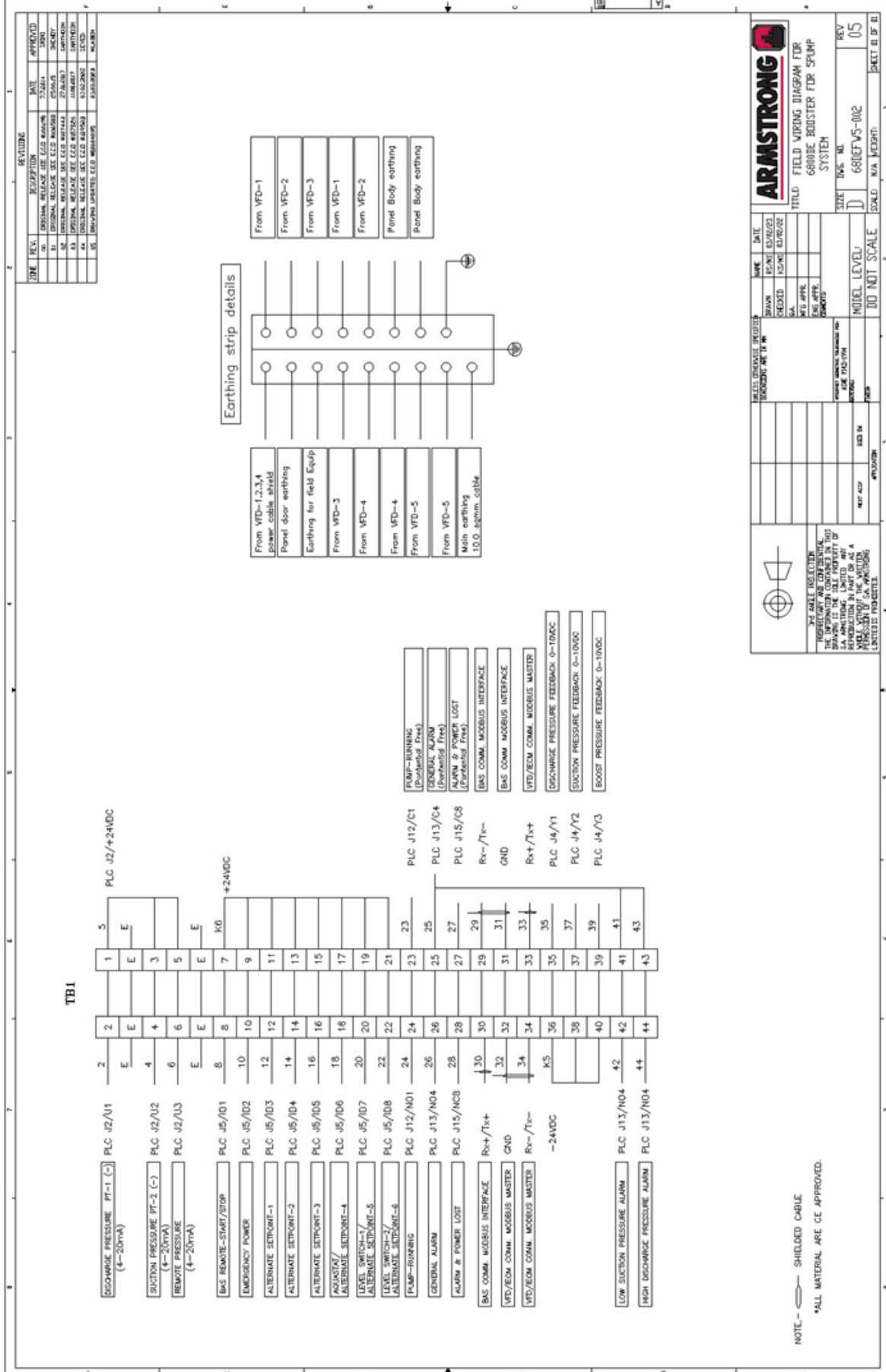

ARMSTRONG

TITLE: FIELD WIRING DIAGRAM FOR 6800G BOOSTER FOR PUMP SYSTEM

DATE: 05/20/20

SCALE: N/A

REV: 05

SIZE: 10x11

NO. OF SHEETS: 02

SHEET NO. OF 02

DO NOT SCALE

ARMSTRONG LIMITED

1000 WEST 10TH AVENUE, DENVER, CO 80202

FOR SINGLE INSTRUCTION THE INFORMATION CONTAINED IN THIS DRAWING IS THE SOLE PROPERTY OF ARMSTRONG LIMITED. NO REPRODUCTION IN PART OR AS A WHOLE WITHOUT THE WRITTEN PERMISSION OF ARMSTRONG LIMITED IS PERMITTED.

TORONTO

23 BERTRAND AVENUE,
TORONTO, ONTARIO,
CANADA, M1L 2P3
+1 416 755 2291

BUFFALO

93 EAST AVENUE, NORTH
TONAWANDA, NEW YORK,
U.S.A., 14120-6594
+1 716 693 8813

DROITWICH SPA

POINTON WAY, STONEBRIDGE CROSS
BUSINESS PARK, DROITWICH SPA,
WORCESTERSHIRE,
UNITED KINGDOM, WR9 0LW
+44 121 550 5333

MANCHESTER

WOLVERTON STREET, MANCHESTER
UNITED KINGDOM, M11 2ET
+44 161 223 2223

BANGALORE

#18, LEWIS WORKSPACE, 3RD FLOOR,
OFF MILLERS - NANDIDURGA ROAD,
JAYAMAHAL CBD, BENSON TOWN,
BANGALORE, INDIA 560 046
+91 80 4906 3555

SHANGHAI

UNIT 903, 888 NORTH SICHUAN RD.
HONGKOU DISTRICT, SHANGHAI
CHINA, 200085
+86 21 5237 0909

BEIJING

ROOM 1612, NANYIN BUILDING NO.2
NORTH EAST THRID RING ROAD
CHAOYANG DISTRICT, BEIJING,
CHINA 100027
+86 21 5237 0909

SÃO PAULO

RUA JOSÉ SEMIÃO RODRIGUES
AGOSTINHO, 1370 GALPÃO 6 EMBU
DAS ARTES, SAO PAULO, BRAZIL
+55 11 4785 1330

LYON

93 RUE DE LA VILLETTE
LYON, 69003 FRANCE
+33 4 26 83 78 74

DUBAI

JAFZA VIEW 19, OFFICE 402
P.O. BOX 18226 JAFZA,
DUBAI - UNITED ARAB EMIRATES
+971 4 887 6775

JIMBOLIA

STR CALEA MOTILOR NR. 2C
JIMBOLIA 305400, JUD.TIMIS
ROMANIA
+40 256 360 030

FRANKFURT

WESTERBACHSTRASSE 32,
D-61476 KRONBERG IM TAUNUS
GERMANY
+49 6173 999 77 55

ARMSTRONG FLUID TECHNOLOGY®
ESTABLISHED 1934

ARMSTRONGFLUIDTECHNOLOGY.COM