



Varistar 2: Installation, Operation and Maintenance Manual



Please read all these notes carefully,

CE CONFORMITIES:

For Declaration of Conformities see Armstrong Holden Brooke Pullen.

INTRODUCTION

This leaflet contains specific information regarding the safe installation, operation and maintenance of Varistar 2 pumps.

These instructions must be read and understood by anyone responsible for the installation, operation and maintenance of this equipment.

Our equipment has been designed and constructed to be safe and without risk to health and safety when properly installed, used and maintained, providing that our instructions are carefully adhered to. If in doubt contact Armstrong Holden Brooke Pullen, quoting the serial number.

WARNING SYMBOLS



Safety instruction where an electrical hazard is involved.



Safety instruction where non-compliance would affect safety.



Safety instruction relating to safe operation of the equipment. (ATTENTION)

GENERAL NOTES

1. Applications

The circulating pump is used to ensure the circulation of liquids in heating installations using hot water.

This pump cannot, in any circumstances, be used for drinking water or foods.

2. Characteristics

Identification Plate

VSS52-08-1

- Electronic module _____
- Single pump, immersed motor _____
- Twin pump (D) _____
- Nominal diameter of flange _____
- Discharge head in metres _____
at nominal flow rate
- Phase _____

3. Connection and Power

Fluid Conveyed

Heating water in accordance with VDI 2035.

Water/glycol mixture with a maximum glycol content of 40%. If more glycol is added, the discharge values should be modified according to the increase in viscosity. Use only brand name products containing inhibitors providing corrosion protection and comply with the manufacturer's instructions.

NOTE: Consult Armstrong Holden Brooke Pullen when other fluids are used.

- Temperature of fluid:
VSS22-03 & VSS32-05: +20 to +95°C.
- Temperature of fluid all other sizes: +20 to +110°C.
- Ambient Temperature: +40°C Maximum.
- In order to avoid the formation of water by condensation, the room temperature must be lower than the temperature of the discharged liquid.
- Maximum permissible service pressure for the pump (see identification plate).
- Minimum pressure head on suction to avoid cavitation noise (see following tables).

Minimum suction head (m.w.g.) versus operating temperature			
Type	82°C	95°C	
VSS22-03, VSS32-05	1.5M	3M	

Minimum suction head (m.w.g.) versus operating temperature			
Type	70°C	90°C	110°C
VSS/VSD42	9M	13M	20M
VSS/VSD52	8M	12M	19M
VSS/VSD62	5M	9M	16M
VSS/VSD82	10M	14M	21M

These values are applicable for altitudes of up to 300 metres above sea level. (Allow 0.01 bar for every additional 100m elevation).

- Type of protection:
VSS22-03/VSS32-05-IP 43. All other sizes IP42.
 - Mains voltage: Single phase 230V (+/-10%).
 - Frequency: 50Hz (in accordance with IEC38).
 - Insulation all sizes: Class 'F'.
- When ordering any spare parts, the data on the identification plate should be specified.

TEMPERATURE



Where under normal operating conditions the limit of 68°C (restricted zone) for normal touch, or 80°C (unrestricted zone) for unintentional touch, may be experienced, steps shall be taken to minimise contact or warn operators/users that normal operating conditions will be exceeded.

NOISE LEVELS



Maximum sound pressure level of 70dB(A) @ 1 metre unless otherwise stated.

STORAGE

Store in a dry place. Protect against dirt, damage and frost.

INSTRUCTIONS FOR SAFE USE



1. No installation of this equipment should take place until this leaflet has been studied and understood.
2. Handling, transportation and installation of this equipment should only be undertaken with the proper use of lifting gear.

Instructions indicated in this way must be complied with in order to avoid the risk of damaging the equipment and adversely

CAUTION!

TRANSPORT and STORAGE

As soon as the equipment is received, check that it has not been damaged during transport. If any defect is noted, all the necessary steps must be taken with regard to the carrier.

CAUTION!

If the equipment delivered is to be installed some time later, store it in a dry place and protect it against impacts and all external effects (humidity, freezing conditions, etc). The storage temperature must be between : -10°C and +50°C.

PRODUCTS and ACCESSORIES

The pump ref: VSS22-03 & VSS32-05

Threaded ports.

The motor has a wet rotor, the bearings are self lubricating. The withdrawable cover housing the control electronics is delivered installed.

Conformity: TF 110.

Insulation Class: 'F' (155°C).

Protection: IP43.

The motor is self protected by impedance and needs no external protection.

Functions of the VSS22-03 & VSS32-05 pump system.

The circulators have electronic self-regulation: when started up, they adapt to the pressure needs of the installation.

- Adjustment of differential pressure according to installation.

The differential pressure versus loss of head is adjusted when the installation is commissioned:

On the VSS32-05, on potentiometer C (see Fig.3A), settings 1 to 5 for 1 to 5m (see Fig.4A).

On the VSS22-03, on switch B (see Fig.2A) setting 1 (factory presetting) for a differential pressure of 1.5m (see Fig.5A), setting 2 for a differential pressure of 2.5m.

- Automatic adjustment of the differential pressure (see Fig.1A). The system is factory preset to variable ΔP for optimum operation (setting  of switch A; see fig.2A).

The alternative setting, constant ΔP , can be selected by setting switch A to  (see Fig.2A), useful in particular for adjustment of the equalization valves.

- Automatic adjustment of differential pressure in standby mode (see Fig.6A), on the VSS32-05 circulator only.

This option is not compatible with an installation that includes instantaneous hot water production and does not have a three-way valve for heating regulation.

The circulator is factory preset to the comfort setting  of switch B (see Fig.2A), so as to operate only on the differential pressure curve adjusted as described above.

The standby setting  (of switch B (see Fig.2A) may be chosen in the following cases:





- On installations with a day or week clock to limit heating to standby mode, say at night or during periods of non-occupancy (week-end)
- On installations with regulated three-way valves: automatic optimization of flow, for example at mid-season, or for installations having a high thermal inertia.

Remark:

VSS22-03 & VSS32-05 circulators systematically start at maximum motor torque and maintain it for about 20 seconds for optimum starting in any operating mode of the VSS system.

VSS22-03 & VSS32-05 circulators are automatically set to the maximum hydraulic curve if the electronics malfunction (see section **Operating Problems**).

The automatic adjustment of the differential pressure by the VSS system, once set to variable ΔP or constant ΔP , instantaneously follows any variation of the losses of head of the thermostat valves.

Switching from the standby curve  to the comfort curve  is delayed about 5 minutes and switching from the comfort  curve to the standby curve  is delayed about 30 minutes to avoid any perturbation of the mode during adjustments or when there is demand for instantaneous hot water.

ALL OTHER VSS & VSD PUMP SIZES

The pumps are fitted with an immersed motor which has all its moving parts immersed in the liquid conveyed. According to the type of construction, the liquid conveyed lubricates the impeller shaft with journal bearing. The pumps can be fitted in single or dual pump configuration on the heating system.

An electronic module is located on the housing (see Fig.2). This controls the differential pressure of the pump so that the adjusted set-point value remains within the setting range. The differential pressure is governed by the different criteria according to the type of setting. For all types of setting, however, the pump is capable of constantly adapting to changes in the required characteristics including, in particular, in the case where thermostatic valves or mixers are added.

Main Advantages of Electronic Control

- Economizing of discharge valves.
- Energy savings.
- Attenuation of flow noises.

Types of Setting That Can Be Selected

Δp-c - The electronic module keeps the differential pressure generated by the pump constant at the set-point differential pressure value H_s until the maximum characteristic operating curve is reached, by means of the authorised flow rate condition. (see Fig.3).

Δp-v-The set-point differential pressure value to be ensured by the pump is modified in a linear manner by the electronic module between H_s and $1/2H_s$. The set-point differential pressure value H increases or decreases with the required flow rate. (see Fig4).

Controller Mode

The pump rotation speed is maintained at a rotation speed of n_{min} and n_{max} (see Fig.4) The operating mode controller de-activates the control on the module.

In the "**auto**" operating mode, the pump is capable of recognizing a minimum heating power requirement of the system by decreasing the temperature of the discharged liquid and, therefore, of placing itself in standby configuration (minimum curve). When the power requirement increases, the pump is automatically re-activated in controlled mode.

The pumps are equipped with **an electronic system protecting against overloads** which shuts down the pump if an overload occurs on the motor.

The module is equipped with a non-volatile **memory** for data storage. Data is preserved in the event of a power line disturbance of any duration. When the power is restored, the pump restarts in accordance with the settings specified before the power line disturbance.

The module's identification plate is bonded in place in the connection compartment. It contains all the information regarding the type of module.

Pump Priming Pulse

Pumps that are shut down with the on/off control are started up for a few moments every 24 hours in order to avoid any blocking due to long periods out of service.

When it is planned to switch off the power for a long period, the pump priming pulse must be ensured by the heating/boiler control.

The pump must be connected up for this purpose (Display -> on).

External "Off" Control

(For pumps with maximum $P1 \geq 560W$. See identification plate).

The pump must be energised/de-energised via the external dry contact. In case of installations requiring frequent switching operations (switching on/off more than 20 times a day), provision must be made for switching on/off by means of the external "off" control.

Input 0-10V

(For pumps with maximum $P1 \geq 560w$ only. See identification plate).

In the case of operation by controller, the rotation speed can be controlled by an external voltage signal (0-10V). The frequency and thus, the rotation speed depends on the voltage as shown in Fig.5. Input resistance: $R_i \geq 10K\Omega$.

Output +24V

(For pumps with maximum $P1 \max \geq 560w$ only: see indication plate).

Dry contact voltage for an external receiver/transmitter. The voltage of +24V can be loaded with 50mA maximum. The voltage can withstand short circuits.

OPERATION IN DUAL PUMP MODE

Both pumps are controlled by the master pump. If a problem occurs on one of the pumps, the remaining pump operates in accordance with the commands of the master pump.

Module IF (Interface)

An IF module, connected to a multiple connector in the connection compartment for the two pumps, is required to allow communication between the master pump and the slave pump or between the pump and the computer controlling the pumps or the interface converter (see Fig.2). This module is available as optional equipment.

Operation In Parallel

The rated power is supplied by the two pumps operating in parallel. At low load, only the main pump operates while the second remains in reserve status.

When the load increases, the main pump steps up its performance until reaching the point of intersection between the power curves.

This means, that if the power consumed by a single pump at high speed exceeds the power consumed by both pumps operating in parallel, the second pump is started up and the two pumps synchronize their speeds in order to remain on the curve representing the lowest level of electric power consumption.

Normal/Standby Operation

The required performances are provided by a single operating pump (low or high load).

The other pump is only started up in the event of failure of the first pump.

The main pump and the standby pump are automatically switched every 24 hours of actual operation.

Communication Interrupt

The slave pump only operates in accordance with the most recent information received by the master pump.

If one of the pumps fails, the other operates in normal mode as a single pump.

Master pump off: the slave pump is automatically disengaged.

External "Off" Control, 0-10V, Output 24V









(For pumps with $P1 \geq 560w$ only: see identification plate). Connected to the master pump only and affecting the whole system.

PUMP CONTROL

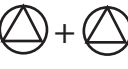
A red LED (see Fig.2-item 3) is illuminated in the window when a problem occurs.

Liquid Crystal Display (see Fig.2-item 4)

The LCD display indicates the pump setting parameters by means of symbols and numerical values. The lighting-up of the display cannot be switched. The various symbols have the following meanings:-

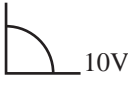
Symbol	Description of the various Operating Modes
auto 	Normal operation: authorisation for automatic switching to low load mode. Low load mode is activated when there is a minimal heating power requirement (night mode).
auto 	The pump runs in low load mode (decrease at night) with a minimum rotational speed.
(no symbol)	Interruption of automatic switching to low load mode so that the pump runs in normal regulated mode only.
	Low load mode activated by the interface converter, independently of the system temperature.
	The dual pump operates in maximum load mode (master + slave) in parallel.
	The dual pump operates in main/reserve mode (master or slave) on Normal/Standby basis.
H  m	The set point differential pressure value is set to H = 9.0m.
	The pump is regulated to a constant rotational speed (1800 rpm in this case) (regulating mode).
	Constant Δ p-c adjustment: adjustment to a constant set point differential pressure value (see Fig.3).
	Variable Δ p-v adjustment: adjustment to a variable set point differential pressure value (see Fig.4).
	The operating mode controller deactivates module adjustment. The pump rotational speed is maintained at a constant value between 800 and 2,800 rpm. The rotational speed is adjusted internally on the rotary knob.
	When controller mode is activated, the pump rotational speed is adjusted by the 0-10V input. In this case, the rotary knob plays no part in indication of the set point value.
On	The pump is on.
Off	The pump is off.

Using the Rotary Knob (see Fig.2-item5)

Starting with the basic setting, a setting menu is selected in a predefined order each time you press the knob (press for longer than one second for the first menu). The selected symbol flashes. When you turn the knob to the left or to the right, the parameters in the display are decreased or increased. The new setting symbol flashes. You then go on to the next menu.

The set-point value (differential pressure or rotation speed) can be modified in the basic setting by turning the regulating knob. The new value flashes. The new set-point value is selected when you press the knob.

If you do not make any of these adjustments, the basic setting re-appears after 30 seconds.

When the single pump display is changed, the following menus appear in succession:

Single pump operation: setting when first placing the appliance in service.

SEQUENCE OF MENUS IN CONTINUOUS OPERATION

Liquid Crystal Display

Setting

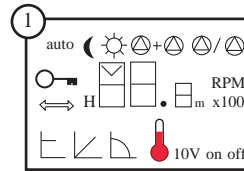

When the module is switched on, all the symbols are displayed for 2 seconds. The current setting is then displayed (2).

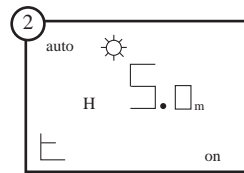

Current basic setting (factory setting)

-> night reduction function authorized: the pump operates in normal mode.



-> pump only.

e.g. H=5.0m



-> A set-point discharge head $H_s=5.0m$ c with $1/2 H_{max}$ (Factory setting depending on type of pump).



-> Setting $\Delta p-c = 5m$.

on

-> Pump on.



The value of the set-point differential pressure is modified by turning the regulating knob. The new differential pressure is displayed in flashing mode.

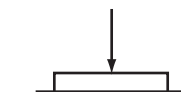

Press briefly to select the new setting.

If you do not press the knob, the set-point differential pressure value displayed in flashing mode returns to the previous setting after 30 seconds.

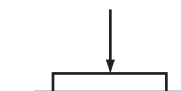

Press the control knob for longer than one second.

The following menu is displayed.

(3)

When no setting is selected for 30 seconds in the following menus, the new basic setting is displayed. (2)

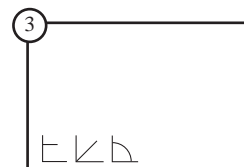

The current setting type flashes.

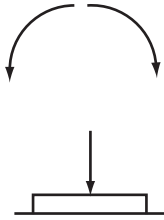

Turn the regulating knob to select other types of setting. The new type of setting is displayed in flashing mode.

Press the knob to select the new type of setting and proceed to the next menu. ④

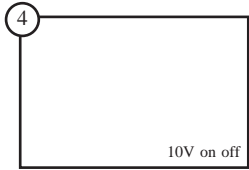

This menu ④ is only displayed in the following circumstances: pump power $P1 \geq 560w$ and selected controller.

For the operation controller via signal 0-10V:

The display indicates "10V On Off". Activate or deactivate operation of the controller. The current setting flashes.

The other setting flashes.

This activates operation of the external controller.

This deactivates the operation of the external controller. The location speed can be adjusted on the pump by means of the rotary knob.

To select the setting.

For all other types of setting the display indicates "on/off".

Switch the pump on or off with the rotary knob.

To select the setting.

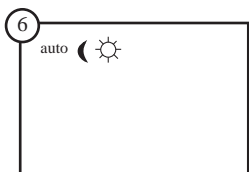

->night reduction function authorized: Menu ② then contains auto during automatic standard operation or auto for the night reduction function.

-> Normal standard operation night reduction operation locked.

No symbol is then displayed in menu ②.

Choose one of the two settings and make your selection.

The display moves on to the next menu.

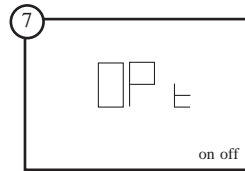

OPT -> Optimization, no load and maximum rotation speed. Pump measurement detection is optimized once when placing in service. For this purpose, it should be checked that the shutdown device on the discharge side is closed so that the discharge quantity $Q = 0$ ("off flashes").

Turn to "on".

Optimization is started. When "off" flashes again, optimization has been completed. The controls are locked during optimization.

In single pump function, the display returns to the basic setting ②

If there is any problem, the problem menu ⑩ is displayed before the basic setting ②.

In dual pump function, the display proceeds to menu ⑧.

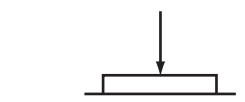
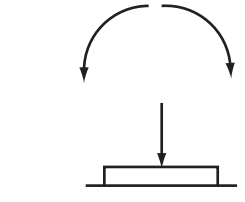

Dual pump operation: setting when first placing in service.

Liquid Crystal Display

Setting

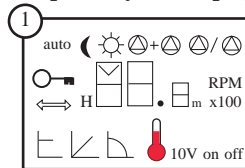

When the module is switched on, all the symbols light up for 2 seconds. Then, menu 1a is displayed.



In the display of the two pumps, the symbol "MA" = Master flashes. If no setting is selected, both the pumps operate at a constant rotation speed ($H_s = 1/2 H_{max}$ when $Q=0$).

When the pump regulating knob is pressed, the display shows the operating mode ⑨. The display of the right-hand pump automatically shows SL= Slave.

In this way, the locations of the master pump on the left and the slave pump on the right are chosen. The rotary knob for the slave pump is then inhibited and settings can no longer be made on that knob.

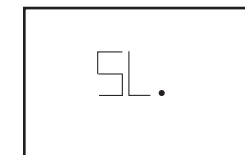
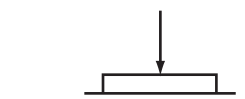

Dual pump function: sequence of menus in routine operation:

Liquid Crystal Display

Setting

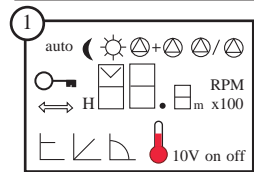

When the module is switched on, all the symbols ① are displayed for 2 seconds. The current setting ② is then installed. If you browse through the MA display, the same sequence of menus ② ⑦ is displayed as for a single pump. The MA menu is then continuously displayed.



When you turn the knob to MA, the display reads SL.

When you confirm SL by pressing the knob, the other pump (right-hand) becomes the master pump. This is how to switch the master and slave pumps. In this way, only the right-hand pump (MA) can then be programmed.

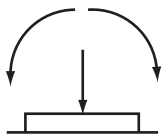

Settings cannot be made on the slave pump, SL. Switching from master pump to slave pump can only be carried out on the master pump.

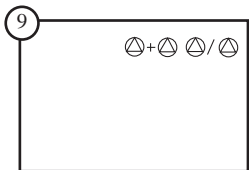

Setting - **Maximum load operation or main/reserve.** The current setting flashes.

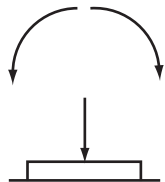

The other setting flashes.

To select the setting. The display returns to the basic setting ②.

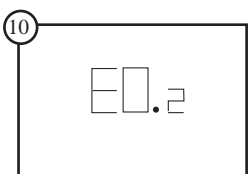

If a problem occurs, it is indicated by **E** (Error) and the relevant **code number**.

See section "**Fault Identification and Remedial Actions**" for the code numbers and their meanings.

The error is cleared if you press the knob for more than one second.

SUPPLIED ACCESSORIES

- Complete pump, seals and bolts, fitting and commissioning manual.

ACCESSORIES (OPTIONAL)

- **For models VSS22-03 & VSS32-05.** Unsticking device to make freeing the motor shaft easier. Block valves.

For all other models:

- Module IF (for connection with OPP/interface converter or a second Varistar 2). For a dual pump set or two separate Varistar 2 appliances, two IF modules are required for automatic control of the dual pump function.

INSTALLATION

Models VSS22-03 & VSS32-05

Assembly (See Figs. 1A and 2A).

- Make sure that the circulator is accessible.
- Direct mounting on pipe, preferably vertical, if possible on the boiler return circuit; never at the low point (to avoid deposits).
- The motor shaft must be horizontal (see Fig.8A).
- The arrow on the pump casing indicates the direction of water flow (see Fig.7A).
- Provide a discharge check valve and isolating valves to facilitate removal and servicing.

CAUTION! If the circulator is insulated, it is best not to block the notches on the motor flange (see Fig. 7A).

Orientation of Terminal Box

If necessary, the orientation of the motor, and thus of the terminal box, can be changed.

- Remove the motor attachment screws and turn the motor to the desired position.
- Possible terminal box positions are at 3, 9 and 12 o'clock..



Take care not to damage the casing gasket, and to re-fit it correctly.

ALL OTHER MODELS

The pump must be fitted in a dry, well ventilated place that is protected from frost.

Work on fitting must not be started before finishing all the necessary welding and brazing operations and, where applicable, the cleaning of the piping. Soiling can adversely affect the correct operation of the pump.

Fit the pump in an easily accessible location in order to make subsequent maintenance work easier.

It is recommended that isolating valves should be fitted upstream and downstream of the pump. This avoids having to drain and refill the installation if the pump has to be replaced. Fitting must be carried out in such a way that any leaks cannot flow onto the pump motor or the electronic module.

Fitting must be carried out without applying any stress. Pipes must be fitted in such a way that their weight is not supported by the pump.

The direction of flow must be in accordance with the direction of the arrow marked on the pump casing.

The air inlet to the module's cooler must not be obstructed.

Only the specified fitting positions are authorized (see Fig.6). The pump shaft must be horizontal.

For pumps with P1, $\geq 560w$, the cooling fins of the electronic module must be in the vertical position. If necessary, the motor housing can be turned after loosening the Allen screws.

CAUTION!

When following this procedure, care must be taken to avoid damaging the O-ring located between the supporting tube and the pump casing.

CAUTION!

For installations that are isolated: this is only possible for the pump casing. The condensation water ports on the motor flange must remain open.

ELECTRICAL CONNECTIONS

Electrical connections and checks must be made by an approved electrician in compliance with the local standards.

For Models VSS22-03 & VSS32-05

Complete electrical information about the circulator is given on the data plate.

Power supply network

Use a three-conductor cable (3 x 1.5mm² H05WF) to connect mains power to the corresponding terminals of the circulator: phase (L), neutral (N) and earth(\perp) (See Fig.11A).



The power cable must not touch the pipe or the pump; make sure that it is away from any moisture.

Check the line protection and the mains voltage and frequency.

The circulator must be connected to the mains via a switch with an opening distance, on each pole of at least 3mm. The power outlet must have an earthing contact.

After making the electrical connections, put the cover back on the terminal box. The control electronics is in this cover, and is automatically connected when the cover is fitted.

ALL OTHER MODELS

In accordance with standard VDE 0730, Part 1, electrical connection must be made using a fixed connecting conduit (with a minimum cross section of 3 x1.5mm²) fitted with a connector or a multipole contactor with a minimum opening of 3mm (H05W-F3 G1.5). The cable must be fed through the packing gland, PG 13.5 (See Fig.2-Item 6).

After taking steps to avoid any risk of water infiltration and ensuring that any pulling force on the packing gland has been relieved, use cables with an outside diameter of between 8 and 12mm and clamp them sufficiently tightly. In addition, the cables should be looped near the packing gland in order to form a "U" to drain any water drips. Uncovered packing glands must be closed with the available leak-tight plates and clamped sufficiently tightly.

To ensure that the connecting cables can be adapted to the inside diameter of the packing glands, the seals consist of concentrically arranged rubber washers and the inside of the washer or washers can be removed, if necessary.

If the pump is fitted in installations discharging water at a temperature exceeding 90°C, the connecting cable used must withstand that temperature.

The connecting cable must be positioned so that it never comes into contact with the main pipe and/or pump casings or the motor housing.

The applicable instructions must be complied with if a protective circuit breaker of type F1 is used. In the case of pumps with power of $P1 \geq 560w$, F1 protective circuit breakers with a sensitivity matching the current should be used.

For the purpose of electromagnetic compatibility, the connecting cable must be kept at least 10cm from the module.

Check that the current is compatible with the specifications indicated on the identification plate.

Single phase mains voltage 230V AC (+/- 10%), 50Hz, IEC 38.

Protection by fuses on the power supply side (see identification plate).

- **Connections to the mains supply is made on terminals L, N, PE (see Fig 2 -item 9).**
- Integrated central fault transmission of the dry-contact type is available on terminals SSM (IPC) (see Fig.2-SSM terminals).

Contact Load:

- Authorised minimum: 12V DC, 10mA.
- Authorised maximum: 250V AC. 1A.
- Dry contact opening on fault.

If the IF module is connected on the multiple connector in the connection compartment.

- **External "off" control (see Fig.2-ext.off):** this is used for remote switching on/off.
- Remove the original shunt.
- Connect up to the external switch via the packing gland (see Fig.2-item 8).

Switch closed = on.

Switch open = off.

- **DP (connection terminals for dual pump):** For the dual pump function, make connection with the corresponding terminals on the second pump. Connecting cable: 2 x 0.75...1.5mm², maximum permissible length of 2m. The cables must be fed through the packing glands, PG11 (see Fig.2 - item 7) and PG7 (see Fig.2 -item 8).

The pump and the installation must be earthed in accordance with instructions.



Before carrying out any work on the pump, switch off the power supply. Then wait five minutes before starting work on the module as the contact voltage still present can constitute a hazard for personnel.

Check that there is no voltage on any of the connections (even dry contacts).

**STARTING UP
FILLING, VENTING****FOR MODELS VSS22-03 & VSS32-05**

Never operate the circulator WITHOUT WATER.

- Open the valves on both sides of the circulator and fill the installation completely.
- Bleed the circuit at the high point.
- Bleed air from the circuit manually by unscrewing the plug a few turns, without removing it completely (see Fig.9A).

CAUTION! Risks of scald, pressure is high.

- When water flows out and there are no more air bubbles, screw the plug back in.
- Power up the motor to start the circulator.
- The differential pressure is adjusted to the type of installation on the electronic box (see Figs. 4A, 5A).

CAUTION! Touching the motor may result in burns; its temperature may be above 100°C in operation.

ALL OTHER MODELS



In order to display all the relevant information, the pump and the module must be at ambient temperature.

FILLING, VENTING

Fill and bleed the installation completely. Air is automatically eliminated from the pump impeller compartment after a short period in operation.

The pump is not damaged by no-load operation for a short time.



The pump assembly can become extremely hot depending on the operating conditions of the pump or the installation (temperature of the discharged liquid).

Risk of burns simply by contact with the pump. The cooler can reach a temperature of 70°C in normal service conditions.

Pump Power Adjustment

The installation is designed to run in a given operating point (maximum load condition, maximum heating power requirement). When placing in service, adjust the pump power (discharge head) according to the operating point (see also **Pump Control**). The factory setting is not necessarily suitable for the pump power required by your installation. This power can be determined using the diagram of characteristic curves according to the type of pump selected (see technical manual).

Selection of the Set Point in Δp -c and Δp -v.

Max. operating point	Δp -c Fig.3	Δp -v Fig.4
Located on max. curve = ①	Plot a horizontal line from the desired operating point to obtain the adjusted set-point value Hs ①	
Located in operating zone = ②	Plot a horizontal line from the desired point to obtain the set-point value Hs ② (as above)	Follow the proportional curve towards the straight line as far as the max. curve. Then plot the horizontal on the left to obtain the set-point value Hs ②

SERVICING AND MAINTENANCE FOR MODELS VSS22-03 & VSS32-05

The circulator needs no special servicing in operation.

After a prolonged shutdown make sure that the circulator turns freely.

The electronics unit can be ordered separately ("servocontrol kit"). To replace it, remove the cover from the terminal box and replace it with a new one. The connections are made when the cover is plugged into the receptacle.

FOR ALL OTHER MODELS

If the motor section is separated from the pump casing during maintenance or repair work, the O-ring located between the pump casing and the supporting tube must be replaced with a new O-ring. When fitting the motor section, make sure that the O-ring is correctly positioned.

OPERATING PROBLEMS

CAUTION! Make sure that the unit HAS BEEN TURNED OFF before doing any work on it.

FAULT IDENTIFICATION AND REMEDIAL ACTIONS

MODELS VSS22-03 & VSS32-05

Problems, causes and remedies are found in Table 1.

ALL OTHER MODELS

Problems, causes and remedies are found in Table 2.

NOTE:

The use of spare parts not supplied by Armstrong Holden Brooke Pullen will invalidate guarantee. The units must also be installed and maintained as our Operating and Maintenance Manual during the warranty period. Failure to adhere to any of the above will invalidate all guarantees and product responsibility of Armstrong Holden Brooke Pullen.

TABLE 1 Models VSS22-03 & VSS32-05

PROBLEM	POSSIBLE CAUSE	REMEDY
The circulator is noisy.	a). Air in system: b). Suction pressure too low. c). Water flow noise: d). Foreign bodies in impeller:	a). Bleed the circulaor: loosen the plug on the back, bleed until there are no more air bubbles, then screw the plug back in (seeFig. 9A). b). Increase the pressure in the circuit. c). -Adjust the differential pressure as shown in Figs.4A & 5A. - Set the day/night switch to ☾. - Failure of the electronic box and automatic switching to maximum curve of circulator; obtain a "servocontrol kit". The circulator will continue to operate, but on its maximum curve, until the faultycontrol unit is replaced. d). Remove the motor and clean the impeller.
The circulator fails to start.	a). Shaft jammed by fouling after prolonged shutdown: b). No power supply to the circulator: c). Problem in electronic box or capacitor faulty: d). Foreign bodies in impeller:	a). Free the shaft: remove the plug on the back. Use a plain screwdriver to turn the motor shaft, then refit the plug on the back (see Fig.10A). b). Check the connection to the motor. Check the installation fuses. c). Obtain a "Servocontrol Kit". d). Remove the motor and clean the impeller.
No heating.	a). The farthest radiators do not warm up: b). Temperature drops during prolonged use of hot water:	a). Adjust the differential pressure as indicated in Figs. 4A & 5A. b). Set the day/night switch to ✱

ALL OTHER MODELS

Troubles , Causes and Remedies (See Table 2 on next page)

The **first column** in the table shows the code numbers displayed if a problem occurs.

Fourth column -"Manual reset": most fault indications are cleared automatically when the cause of the problem has been remedied. " ● " in this column indicates that the fault must be cleared by manual resetting on the pump.

Fifth column "Shutdown for x errors/24 hours".

X = 1: In the case of serious problems, the installation is shut down immediately when the fault first occurs.

X = 6: If a fault occurs, the pump is stopped. Once the problem has been solved, however, the pump restarts. It is only after the same fault has occurred six times in 24 hours that the pump is shut down durably. The fault must then be cleared by manual resetting.

W: The fault (simple WARNING) is indicated but the fault LED does not react. The pump continues operating and the fault may re-occur with any frequency. The incorrect operation indicated must not last too long. The cause of the problem should be rectified.

TABLE 2 All Models except VSS22-03 & VSS32-05

Code No.	Problem	Fault LED*	Manual Reset	Shutdown for x errors/24h	Causes	Remedy
	The pump does not operate when the power supply input is connected up.	E		W	Faulty electric safety device:	Overhaul the safety devices:
				W	No voltage on pump:	Rectify break in supply:
E02	Water temperature <20 ⁰ C.	E		W	Heat regulator is incorrectly adjusted:	Set to a lower temperature
E03	Water temperature>110 ⁰ C.	E		W	Heat regulator is incorrectly adjusted.	Set to higher temperature
E04	Under voltage on power system.	A	●	<5min.:W >5min.:X=6	Power system overloaded.	Check the electrical installation.
E05	Overvoltage on power system.	A	●	<5min.:W >5min.:X=6		
E10	Pump blocked	A	●	X = 1	For example: clogging.	The unblocking procedure is engaged automatically. If the blockage is not cleared after 10 seconds, the pump is switched off. Call customer support.
E11	Pump operates in no load mode.	E		W	Air present in pump.	Bleed the pump and the installation.
E20	Overheating of winding.	AE	●	X = 6	Motor overloaded.	Allow the motor to cool. Adjust.
					Water temperature too high.	Decrease the water temperature.
E21	Motor overloaded.	A	●	X = 6	Deposit in pump.	Call customer support.
E23	Short circuit / contact with earth.	A	●	X = 6	Failure of motor.	Call customer support.
E25	Faulty contact.	A	●	X = 6	Module incorrectly fitted.	Re-install the module.
	Break in winding.	A	●	X = 6	Failure of motor.	Call customer support.
E26	Break in temp. probe.	A	●	X = 6	Failure of motor.	Call customer support.
E27	Faulty rotation speed sensor.	E		W	Pump turns in standby conditions (fixed characteristic curve) according to the adjusted set-point value. When the command signal returns, the pump switches to standard mode after 5 minutes.	Call customer support
E30	Overheating of module.	A	●	X = 6	Reduced air supply to module cooler.	Restore air supply.
E31	Overheating of power element.	A	●	X = 6	Ambient temperature too high.	Improve ventilation in the premises.
E36	Faulty module.	A		X = 1	Faulty electronic components for pumps with P1 ≥ 560W.	Call customer support / replace the module.
E38	Faulty liquid temperature sensor.	E		W	Faulty module (reduction function). Faulty motor for pumps with P1 ≤ 430W.	Call customer support.
E50	OPP communication problem.	E		W	Faulty interface or link: IF modules incorrectly connected or faulty cable.	After 5 minutes, OPP mode switches to local control mode.
E51	Unauthorised combination.	E		W	Different pumps	
E52	Master / slave communication problem.	E		W**	IF modules incorrectly fitted or faulty cable.	After 5 minutes, the modules switch to single pump mode. Re-connect the modules. Check the cable.
	Master slave not adjusted.	E		W		Determine master and slave.
MA	Pump is noisy	E			Cavitation due to insufficient pressure:	Increase the system inlet pressure within the authorised limits. Check the adjustment of the discharge head and, where applicable, define a lower head.

NOTE: * : A --> illuminated in continuous mode, E -->LED extinguished.

** : The pump switches from the standard mode to the fixed characteristic curve (according to the set-point values).

w : -> Simple warning without shutdown. (The fault may re-occur at any frequency).

REFERENCE FIGURES FOR MODELS VSS22-03 & VSS32-05

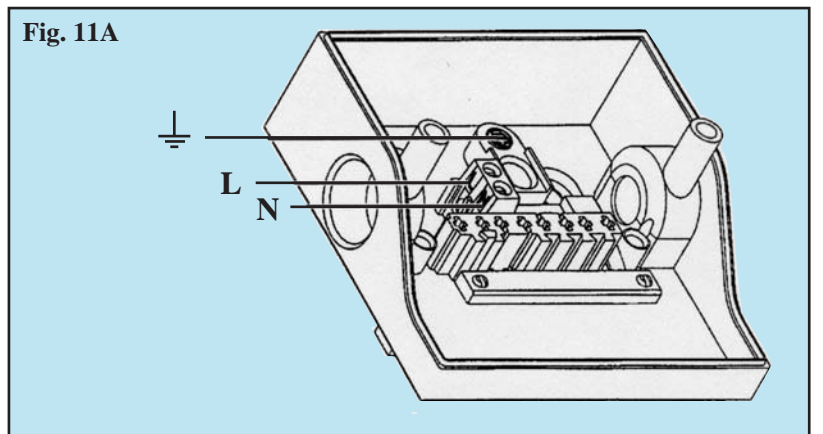
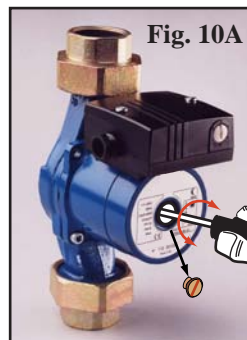
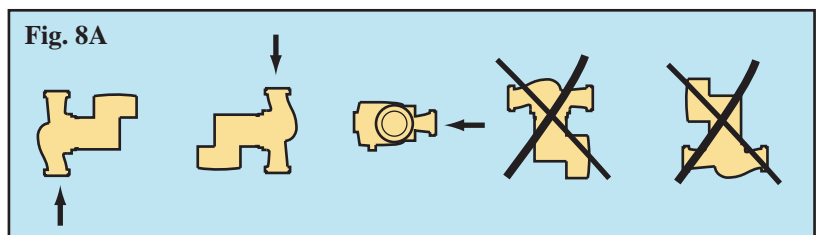
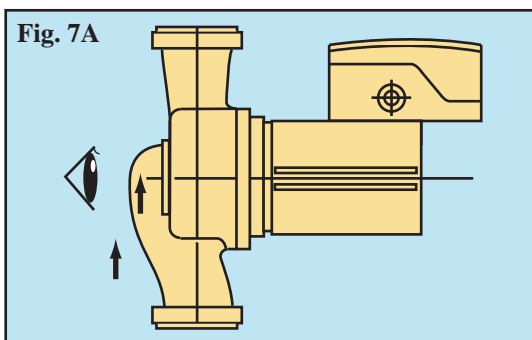
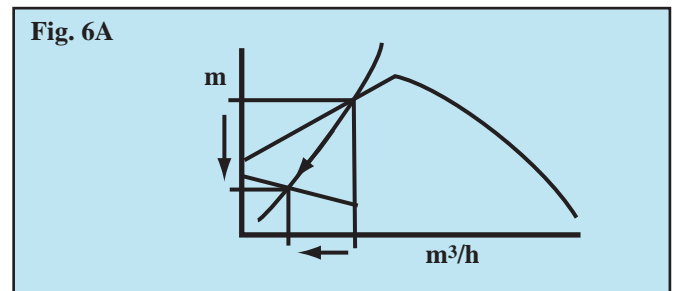
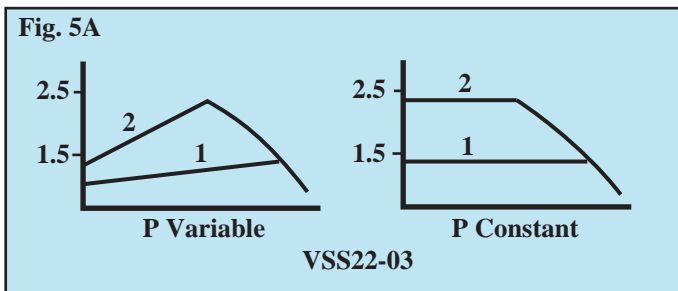
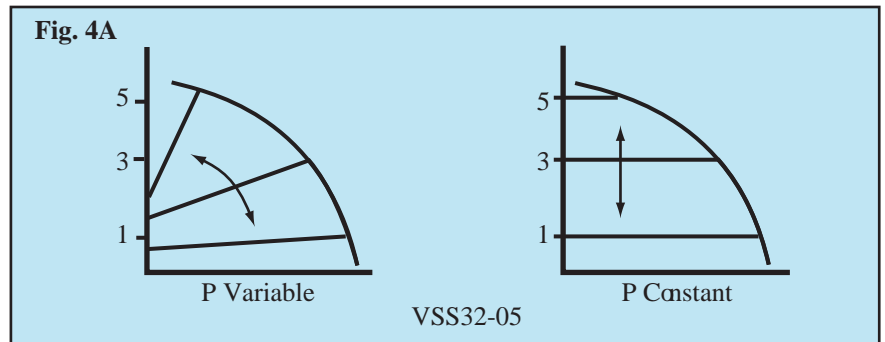
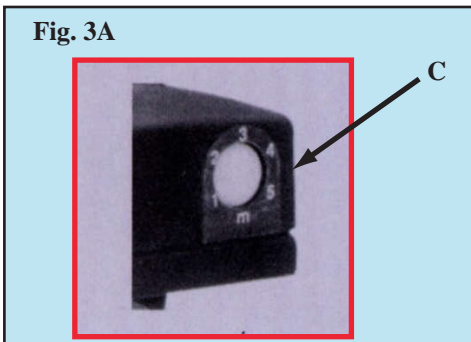
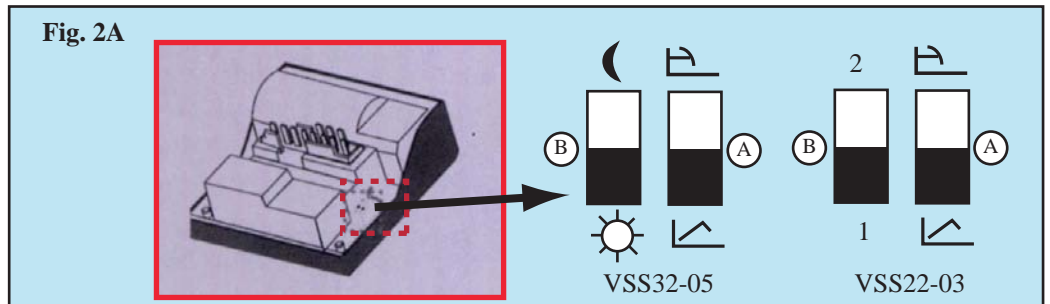
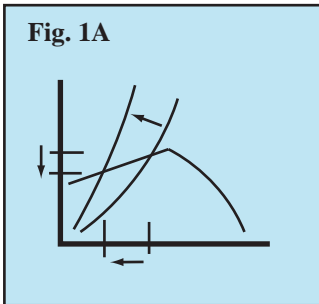

REFERENCE FIGURES FOR ALL MODELS EXCEPT VSS22-03 & VSS32-05

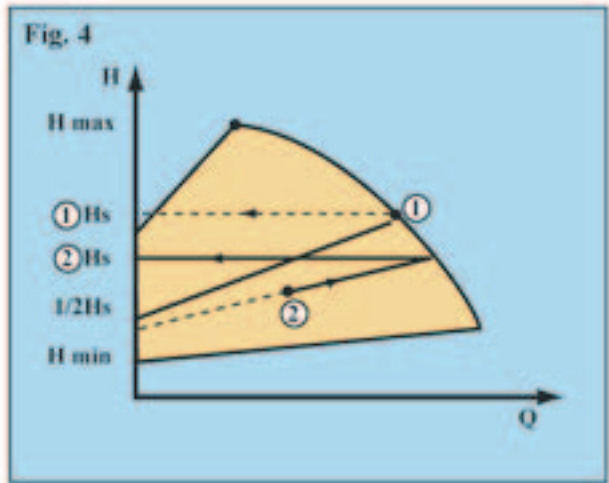
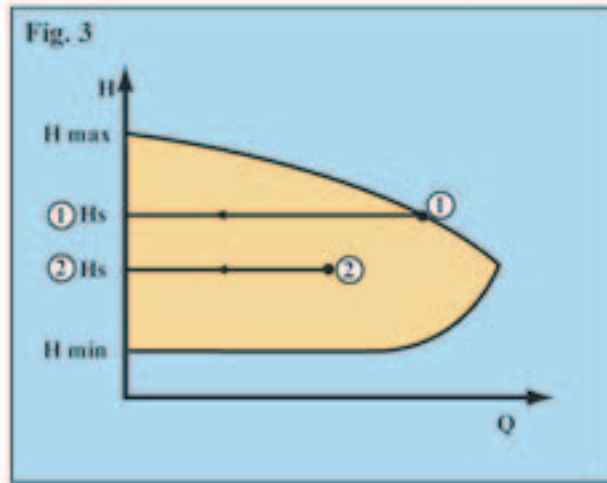
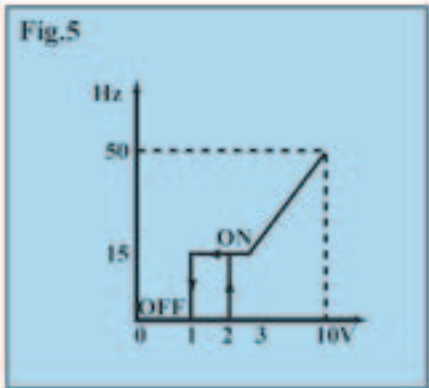
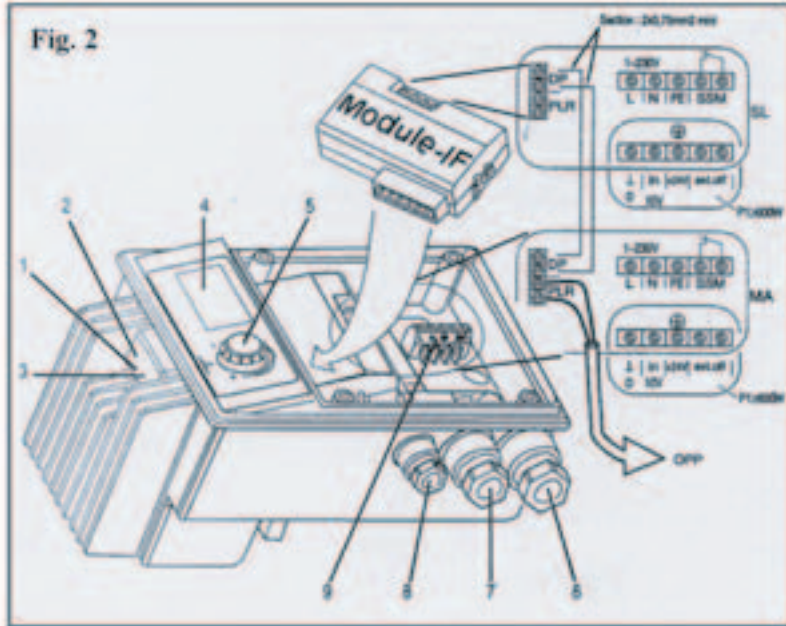
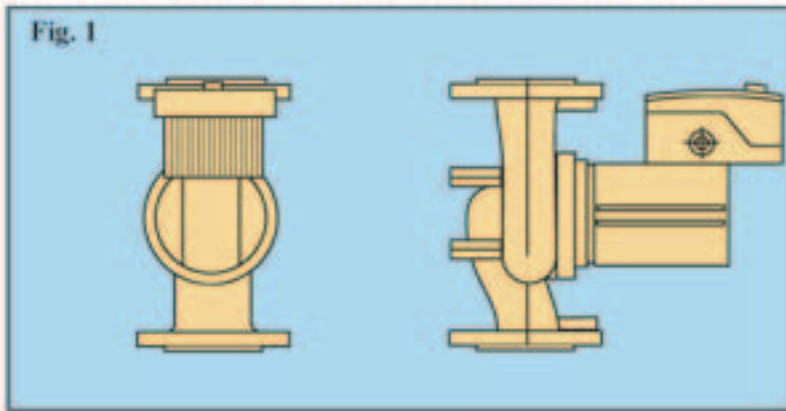

the right to alter our dimensions and specifications without notice

Experience Building...

Export Sales
 Peartree Road, Stanway
 Colchester, Essex
 United Kingdom, C03 0LP
T +44 (0)1206 579491
F +44 (0)1206 760532
E export@armlink.com

UK HVAC Sales North
 Wenlock Way
 Manchester
 United Kingdom, M12 5JL
T +44 (0) 1612 232223
F +44 (0) 1612 209660
E salesuk@armlink.com

UK HVAC Sales South/Service
 21-23 Ormside Way
 Holmethorpe Industrial Estate
 Redhill, Surrey, RH1 2NT
T +44 (0) 1737 378100
F +44 (0) 1737 378140
E salesuk@armlink.com

