

---

# Parallel Sensorless pump controller

---

## Installation and operating instructions

For up to four pumping units with Sensorless control operating in parallel

**File No:** 90.680IN

**Date:** SEPTEMBER 23, 2013

**Supersedes:** NEW

**Date:** NEW

---

—

—

—

—

# CONTENTS

<b>1.0</b>	Sequence of Operation	5
<b>1.1</b>	General sequence	5
<b>1.2</b>	Sensorless control	5
<b>1.3</b>	Controller display screen (HMI)	6
<b>1.4</b>	BAS communication (optional)	6
<b>2.0</b>	IVS 102 controls set-up for Parallel Sensorless control	7
<b>3.0</b>	Wiring diagram - pump IVS 102 controls to Parallel Sensorless pump controller	10
<b>4.0</b>	Operation, setup, and alarm management displays	11
<b>4.1</b>	Main setup displays	11
<b>4.2</b>	Pump setup 1 displays	11
<b>4.3</b>	Lead pump switch time setup displays	11
<b>4.4</b>	Speed setup displays 1	12
<b>4.5</b>	PLC clock setup display	12
<b>4.6</b>	Pump PID setup displays	12
<b>4.7</b>	Building Automation System (BAS) interface setup displays (if available)	13
<b>4.8</b>	System sensorless setup displays	13
<b>4.9</b>	System sensorless setup displays	14
<b>5.0</b>	Data points for Parallel Sensorless pump controller	16
<b>5.1</b>	Data points summary	16
<b>5.2</b>	BAS data points - Modbus RTU	17
<b>5.3</b>	BAS data points - BACnet	26
<b>5.4</b>	BAS data points - LonWorks	34

## PARALLEL SENSORLESS PUMP CONTROL

### For up to four pumping units with Sensorless control operating in parallel.

Armstrong Parallel Sensorless pump controllers (PSPC) are completely factory-assembled, tested, and shipped to the job site as integrated on pumping units or stand-alone units, for wall or rack mounting, ready to receive incoming power supply and Sensorless data from the individual pump controls. These instructions describe the procedures to be followed during installation and operation to ensure optimum performance and reliability. When contacting the factory for assistance, please provide the serial number of the closest pumping unit to the controller in the control chain.

This information is to be used as a supplement to the 43001VS and 43801VS (file no: 94.81), 43021VS and 43821VS dualARM (file no: 94.82) and 43121VS & 43921VS TWIN (file no: 94.84) Design Envelope pumping unit installation and operation guides when two - four of the unit rotating assemblies are being operated in parallel with Sensorless control.

This information may also be used for stand-alone controls and controller, providing the pumps and controls were supplied by Armstrong as a package in a quantity of two - four units, including any standby and are provided with Sensorless control configurations.

When the Parallel Sensorless pump controller (PSPC) is mounted and wired on one of the pumping units it is integrated at the factory. The other pump integrated controls will have been/need to be 'daisy-chain' control wired to the controller integrated unit on site by a qualified electrician or controls contractor who will have followed/will follow Armstrong's wiring diagram in File no: 90.651 (see page 10 of this document). If the pumping units are 43021VS or 43821VS dual-ARM units each controls pair may have been pre-wired at the factory. Otherwise, the same wiring diagram (page 10) is to be used for site controls wiring for dualARM units as well.

Wiring diagram (file no: 90.651) is to be used for the controls wiring of a wall-mounted stand-alone PSPC and stand-alone pump controls providing Armstrong has supplied all the matched equipment.

Note that the stand-alone PSPC controller or the integrated controller pumping unit must be at the end of the control chain, as indicated on the wiring diagram

### Building Management System (BMS or BAS) connection

When the Parallel Sensorless Pump Controller is provided with a serial port to communicate to the BMS, the standard communication protocol is BACnet, LonWorks or Modbus. Refer to data points charts at the end of this document (also available separately as File No: 90.682).

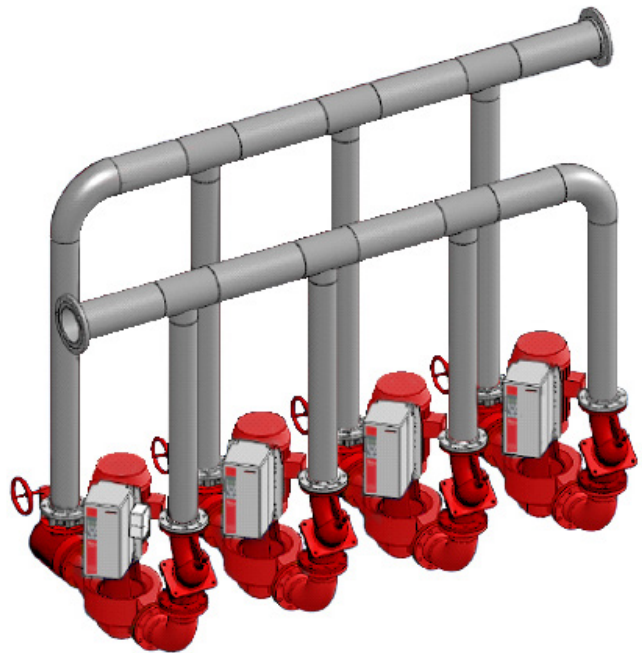

## 1.0 SEQUENCE OF OPERATION

### LIST OF ABBREVIATIONS:

<b>ADJ:</b>	Field Adjustable
<b>AI/AO:</b>	Analog Input/Analog Output
<b>BEP:</b>	Best Efficiency Point (from pump curve data)
<b>BMS:</b>	Building Management System (same as BAS)
<b>DI/DO:</b>	Digital Input/Digital Output
<b>DP:</b>	Differential Pressure
<b>DPS:</b>	Differential Pressure Sensor
<b>HMI:</b>	Human Machine Interface
<b>PSPC:</b>	Parallel Sensorless Pumping Controller

### OPERATION

All individual pump controls must be set in **Auto-mode** for the system to operate automatically. Any individual pump may be set to **Hand-mode** or **Off-mode**. Any pump in **Hand-mode** or **Off-mode** will not be recognized by the automatic sequencing of the PSPC. Any pump placed in **Hand-mode** will start, and may be controlled manually, providing the supply power is available and connected.

#### 1.1 GENERAL SEQUENCE

- 1.1.1 The PSPC has 3 levels of password protection for the setup parameters.
- 1.1.2 When the PSPC is set to **Local**, the system will be activated immediately.
- 1.1.3 When the PSPC is set to **Remote**, the system will turn **ON** or **OFF** according to the status of the signal from the BMS.
- 1.1.4 The control for pump speed is in the PSPC.
- 1.1.5 With PSPC control, pump flow and head from individual pumping units is read by the controller and the speed of the pumps is regulated to maintain an operation point on the control curve at the system demand flow.
- 1.1.6 The total system quadratic control curve is embedded in the PSPC. Head-design value [Hdesign] is the pump/system duty head; Head-minimum [Hmin] is the DP measure across the remote piping leg at full flow. If not known, default to 40% of the pump head. Flow-design is the full system flow which is the total design flow of the number of duty pumps. Armstrong will embed the system control curve in the PSPC; all entered values can be adjusted on site via the PSPC keypad.
- 1.1.7 Automatic rotation of duty pumps is based on a set (adj.) time period. The PSPC will remember the elapsed rotation time in the event of a power failure. Default rotation time is set at 7-days.
- 1.1.8 Alarms will include pump/control failure and general system failure.
- 1.1.9 Alarms are shown in the PSPC display and will Auto-Reset when the alarm condition is corrected. In the event of multiple alarms, the display will scroll to show a different alarm every 10-seconds.
- 1.1.10 Alarms will **Auto-Reset** once the problem is resolved. All duty service **Auto-mode** individual pump controls will start in Sensorless mode, upon PSPC failure, and adjust speed to supply the actual system needs. Unit staging will not occur until the PSPC is repaired or replaced.

#### 1.2 SENSORLESS CONTROL

- 1.2.1 The PSPC can operate up to 4 Sensorless pumps in parallel. The number of standby pumps may be selected as 0 or 1. If 1 is chosen, a maximum of N-1 pumps will be allowed to run simultaneously (unless all are set in **Hand-mode**). Any standby pumping unit will be included in the pump automatic rotation sequence.
- 1.2.2 The PSPC Sensorless Control Setup screen will display the following adjustable parameters: Head-design, Flow-design & Head-minimum (zero flow head)
- 1.2.3 The PSPC will read Head and Flow from each individual pump controls, in addition to current, power, run status, fault status and speed feedback.
- 1.2.4 When the system is activated, or recovering from a power failure, all the duty pumps are started.
- 1.2.5 The PSPC calculates the total flow (Q) as the addition of the flow readings from each running pump. The PSPC uses the head reading from the duty 1 pump as the system head (H).
- 1.2.6 The PSPC is capable of staging and de-staging pumps based on adjustable BEP speeds, which depends on the number of operating pumps. If the pump speed is over the BEP stage-on speed, for the number of operating pumps, the next duty pump is started. Similarly, if the pump speed is under the BEP stage-off for the number of operating pumps, the now-redundant duty pump is stopped.
- 1.2.7 The operating speed of the pump(s) is controlled to maintain the operation point (system head & flow) on the system control curve.
- 1.2.8 Once started a duty pump will operate for a minimum of 10-minutes (adj.).

6

- 1.2.9 The pSPC monitors the flow of each operating pump and if one deviates more than 20% from the average flow, a **Pump Flow Deviation Alarm** is issued.
- 1.2.10 Should the pSPC not receive a pump-run feedback from an activated pumping unit controls within 10-seconds, the pSPC will generate a **Pump Run Feedback Alarm**. The pSPC will attempt to **Auto-Reset** the alarm every 20 seconds.
- 1.2.11 The pSPC will continuously monitor the status of the individual pump IVS102 controls. If the IVS102 generates a fault signal, the pSPC will generate a **Pump Controls Fault Alarm** and display the fault number.
- 1.2.12 Should the pSPC lose communication with an individual pump IVS102 control, perhaps due to a loose or broken wire, IVS102 not properly configured or powered off, the pSPC will generate a **Pump Communication Alarm**.

1.3 CONTROLLER DISPLAY SCREEN [HMI]

1.3.1 Operator screens

- A **Source of control:** Local or remote.
- B **pSPC Status:** On/Off.
  
- C **Pump information:** Running/Off/Alarm, HOA status, Pump ID 1, Pump ID 2, Stand-by, etc.
  
- D **Individual pump controls information:** Speed, Amps, Power, Volts AC, Flow and head.
- E Set point and error of flow & head.
- F Individual cumulative pump hours of operation.
- G System set-point & error.

1.3.2 Alarm screens

- A Alarms with time stamp.
- B Alarm help.
- C Diagnostic indicating status (OK or bad) of PLC, memory, network and communication, PLC software version.

1.3.3 Setup screens. There should be three levels of access:

- A **Level 0** - No password, allows view only access.
  
- B **Level 1** - Allows modification of all parameters, except pump PID and BMS setup. Allows Restoring previously saved values.
- C **Level 2** - Allows modification of all parameters. Allows saving and restoring all parameters.
- D Levels 1 & 2 are password protected.

1.4 BAS COMMUNICATION (OPTIONAL)

1.4.1 The pSPC shall be capable of serial communication with a BMS (Optional) with either of the following protocols:

- A Modbus RTU
- B BACnet MS/TP
- C LonWorks

1.4.2 The following points will be available through all protocols:

- A Total Sensorless Flow
- B Sensorless Head
- C Total Real-Time Power Consumption
- D Pump Speed
- E Individual Pump Run Status
- F Alarm
- G Wire-to-Water system efficiency
- H Number of pumps operating
- I Lead Pump ID
- J Remote Start/Stop
- K pSPC On/Off status
- L **Pump controls information:** Running/Off/Alarm, HOA , Duty 1, Duty 2, Stand-by, etc.
- M **Pump controls information:** Speed, current, power, Volts AC, flow and head.
  
- N Pump hours of operation.
  
- O Set point and error.

## 2.0 IVS-102 CONTROLS SET-UP FOR PARALLEL SENSORLESS CONTROL

The set-up of these parameters is vital to the operation for Parallel Sensorless control. They allow the PSpC to communicate with the IVS-102 drives. In addition to communication, the set-up parameters enable the IVS-102 drives to switch **SETUP 2** to

independent Sensorless control should the drives lose communication with the PSpC. Upon restoration of communication to the PSpC, the IVS-102 drives will automatically switch to being controlled by the PSpC **SETUP 1**.

### IVS-102 PARALLEL SENSORLESS PARAMETER SETTINGS

PARAMETER	NAME	SETUP 1 (PARALLEL SENSORLESS)	SETUP 2 (SENSORLESS)
<b>OPERATION/DISPLAY</b>			
0-10	Active set-up	(9) Multi set-up	(9) Multi set-up
0-12	This set-up linked to	(2) Set-up 2	(0) Not linked
0-20	Display line 1.1 Small	Frequency (Hz, #1613)	Frequency (Hz, #1613)
0-21	Display line 1.2 Small	Power (kW, #1610)	Power (kW, #1610)
0-22	Display line 1.3 Small	Current (A, #1614)	Current (A, #1614)
0-23	Display line 2 large	Feedback (unit, #1652)	Feedback (unit, #1652)
0-24	Display line 3 large	Sensorless readout (#1850)	Sensorless readout (#1850)
<b>LOAD AND MOTOR</b>			
1-00	Configuration mode	Open loop	Closed loop
1-03	Torque characteristics	Variable torque	Variable torque
1-21	Motor power (HP)	Motor nameplate power	Motor nameplate power
1-22	Motor voltage	Motor nameplate volts	Motor nameplate volts
1-23	Motor frequency	60 or 50 per nameplate	60 or 50 per nameplate
1-24	Motor current	FLA per nameplate	FLA per nameplate
1-25	Motor nominal speed (RPM)	Motor nameplate speed	Motor nameplate speed
1-73	Flying start	Enabled	Enabled
<b>BRAKES</b>			
2-17	Over-voltage control	Enabled	Enabled
<b>REFERENCE/RAMPS</b>			
3-02	Minimum reference	0	0
3-03	Maximum reference	Hdesign (in unit of mapped perf data)	Hdesign (in unit of mapped perf data)
3-15	Reference 1 source	(0) No function	(0) No function
3-16	Reference 2 source	(0) No function	(0) No function
3-17	Reference 3 source	(0) No function	(0) No function
3-41	Ramp up time	Desired ramp time (60s typical)	Desired ramp time (60s typical)
3-42	Ramp down time	Desired ramp time (60s typical)	Desired ramp time (60s typical)

**IVS-102 PARALLEL SENSORLESS PARAMETER SETTINGS**

PARAMETER	NAME	SETUP 1 (PARALLEL SENSORLESS)	SETUP 2 (SENSORLESS)
<b>LIMITS/WARNINGS</b>			
4-10	Motor speed direction	Clockwise	Clockwise
4-11	Motor speed low limit (RPM)		
4-12	Motor speed low limit (hz)	Min. frequency of application	Min. frequency of application
4-13	Motor speed high limit (RPM)		
4-14	Motor speed high limit (hz)	Max. frequency of application	Max. frequency of application
4-16	Torque limit mode(%)	100	100
4-18	Current limit(%)	Leave at default (110) or increase if motor has difficulty starting. Do not set beyond s.f. × 100.	
<b>DIGITAL IN/OUT</b>			
5-01	Terminal 27 mode	Input	Input
5-10	Terminal 18 digital input	Start	Start
5-11	Terminal 19 digital input	(o) No operation	(o) No operation
5-12	Terminal 27 digital input	(o) No operation	(o) No operation
5-13	Terminal 29 digital input	(o) No operation	Jog
5-14	Terminal 32 digital input	(o) No operation	(o) No operation
5-15	Terminal 33 digital input	(o) No operation	(o) No operation
5-16	Terminal x30/2 digital input	(o) No operation	(o) No operation
5-17	Terminal x30/3 digital input	(o) No operation	(o) No operation
5-18	Terminal x30/4 digital input	(o) No operation	(o) No operation
5-40	Function relay 1	(o) No operation	(o) No operation
5-40	Function relay 2	(o) No operation	(o) No operation
<b>ANALOG IN/OUT</b>			
6-00	Live zero timeout time	Not used	Not used
6-01	Live zero timeout function	Not used	Not used
6-10	Terminal 53 low voltage	Not used	Not used
6-11	Terminal 53 high voltage	Not used	Not used
6-12	Terminal 53 low current	Not used	Not used
6-13	Terminal 53 high current	Not used	Not used
6-14	Terminal 53 low ref./feedb. value	Not used	Not used
6-15	Terminal 53 high ref./feedb. value	Not used	Not used
6-20	Terminal 54 low voltage	Not used	Not used
6-21	Terminal 54 high voltage	Not used	Not used
6-22	Terminal 54 low current	Not used	Not used
6-23	Terminal 54 high current	Not used	Not used
6-24	Terminal 54 low ref./feedb. value	Not used	Not used
6-25	Terminal 54 high ref./feedb. value	Not used	Not used
6-50	Terminal 42 output	(o) No operation	(o) No operation



**IVS-102 PARALLEL SENSORLESS PARAMETER SETTINGS**

PARAMETER	NAME	SETUP 1 (PARALLEL SENSORLESS)	SETUP 2 (SENSORLESS)
<b>COMMUNICATION AND OPTION</b>			
8-01	Control site	(2) Controlword only	(0) Digital and ctrl.word
8-03	Control timeout time	30	60
8-04	Control timeout function	(8) Select setup 2	(0) Off
8-05	End-of-timeout function	(1) Resume set-up	(1) Resume set-up
8-30	Protocol	(2) Modbus RTU	(2) Modbus RTU
8-31	Address	Unique drive number	Unique drive number
8-32	Baud rate	(3) 19200	(3) 19200
8-33	Parity/stop bits	(2) No parity, 1 stop bit	(2) No parity, 1 stop bit
<b>SPECIAL FUNCTIONS</b>			
14-10	Mains failure	(0) No function	(0) No function
14-11	Main voltage at mains fault	Set to 83.5% of site voltage (note 1)	Set to 83.5% of site voltage (note 1)
14-12	Function at mains imbalance	(0) No function	(0) No function
14-60	Function at over temperature	(1) Derate	(1) Derate
14-61	Function at inverter overload	(1) Derate	(1) Derate
14-62	Inverter overload derate current (%)	95	95
<b>DRIVE CLOSED LOOP</b>			
20-00	Feedback 1 source	Sensorless pressure	Sensorless pressure
20-02	Feedback 1 source unit	Unit used for feedback 1 source	Unit used for feedback 1 source
20-12	Reference/feedback unit	Unit of par 2021 (ex: ft wg)	Unit of par 2021 (ex: ft wg)
20-13	Minimum reference/feedb.		
20-14	Maximum reference/feedb.	Max of head and flow mapped	Max of head and flow mapped
20-20	Feedback function	Minimum	Minimum
20-21	Setpoint 1	Design head in unit in par 2012	Design head in unit in par 2012
20-60	Sensorless unit	Unit of par1850 (ex: GPM)	Unit of par 1850 (ex: GPM)
20-70	Closed-loop type	Not used	Not used
20-71	PID performance	Not used	Not used
20-93	PID proportional gain	Start at 0.05	Start at 0.05
20-94	PID integral time	Start at 0.1	Start at 0.1
<b>APPL. FUNCTIONS</b>			
22-43	Wake up speed (Hz)	Not used	Not used
22-50	End of curve function	Off	Off
22-80	Flow compensation	(1) Enabled	(1) Enabled
22-81	Square-linear curve approximation	100% (note 2)	100% (note 2)
22-84	Speed at no-flow (Hz)	Not used	Not used
22-86	Speed at design point (Hz)	Not used	Not used
22-87	Pressure at no-flow speed	40% of maximum system head	40% of maximum system head
22-89	Flow at design point	Flow at design point	Flow at design point

**NOTES:**

For example - if 575v on site, set parameter to 480v  
Quadratic: 100, Linear: 0, interpolate in between.

### 3.0 WIRING DIAGRAM - PUMP IVS-102 CONTROLS TO PARALLEL SENSORLESS PUMP CONTROLLER (PSPC)

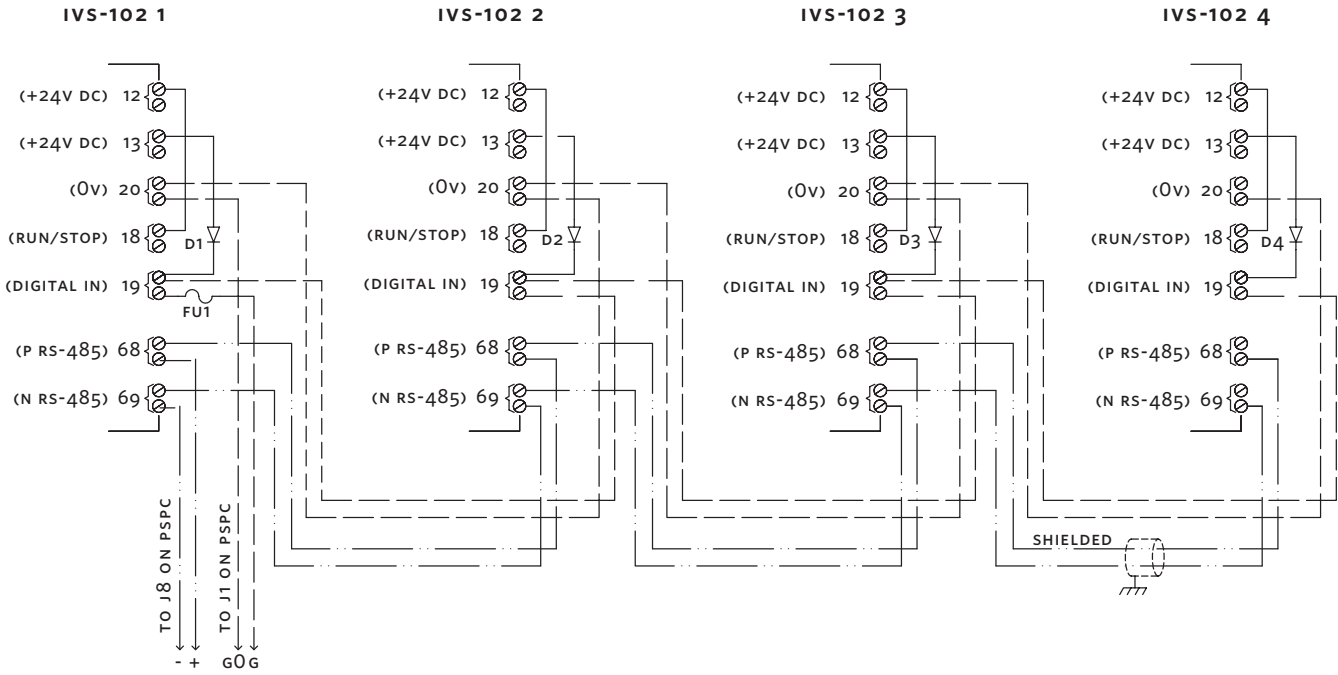

**PSPC**

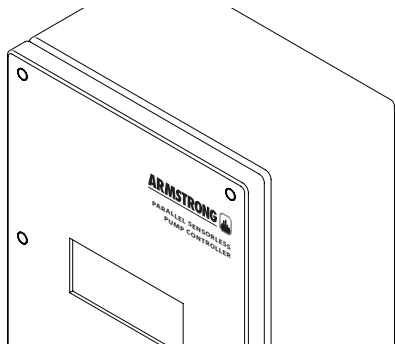

**NOTES**

- 1 Dashed lines indicate wires to be installed by electrician on standalone PSPC. Integrated PSPC will be factory wired to IVS-102 1.
- 2 Zener Diode, 250mA, 200V used.
- 3 All wiring shown is 20 AWG copper, stranded, twisted pair.
- 4 Communication wiring should be shielded, twister pair.
- 5 The +24v being supplied to the PSPC will be connected from all drives. This ensures PSPC remains fully powered should the IVS-102 drive it is directly connected to goes off-line.

## 4.0 OPERATION, SETUP, AND ALARM MANAGEMENT DISPLAYS

### 4.1 MAIN SETUP DISPLAYS



- These are the first displays to appear when entering the Log In password for Level 1 and 2 respectively.
- When the cursor is at the top left corner of the screen, pressing the **UP** or **DOWN** arrow will navigate between the active setup screens of the respective Level.
- On the Level 1 display pressing the **ENTER** key will move the cursor over **YES**.
- When the cursor is over **YES** pressing the **UP** or **DOWN** arrow will **Restore the default settings for all the values in all the setup displays**. This is indicated by the text changing from **YES** to **DONE** for a few seconds.
- On the Level 2 display pressing the **ENTER** key will move the cursor over **YES** beside **SAVE DEFAULT**, and **RESTORE DEFAULT**.
- When the cursor is over **YES** beside **SAVE DEFAULT** pressing the **UP** or **DOWN** arrow will **Save the Setup Values in all Setup Displays as Default Values**. The text will change between **YES** to **OK** for a few seconds.
- When the cursor is over **YES** beside **RESTORE DEFAULT** pressing the **UP** or **DOWN** arrow will **restore the default settings for all the values in all the setup displays**. The text will change between **YES** to **OK** for a few seconds.

### 4.2 PUMP SETUP 1 DISPLAYS

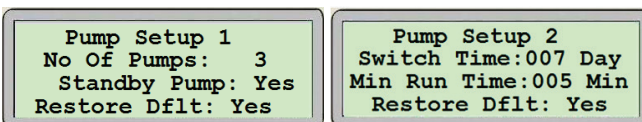

- When the cursor is at the top left corner of the screen, pressing the **UP** or **DOWN** arrow will navigate between the active setup screens of the respective Level.
- Pressing the **ENTER** key will move the cursor over the adjustable fields, over **YES** beside Save and Restore and back at the top left corner.
- When the cursor is over the value beside **NO OF PUMPS**, press the **UP** or **DOWN** key to select the number of pumps.
- When the cursor is over the value beside **STANDBY PUMP**, press the **UP** or **DOWN** key to select **YES** or **NO**.
- When the cursor is over **YES** beside **SAVE** pressing the **UP** or **DOWN** arrow will **Save the settings on this screen as**

**Default Values.** The text will change between **YES** to **OK** for a few seconds.

- When the cursor is over **YES** beside **RESTORE DFLT** or **RESTORE** pressing the **UP** or **DOWN** arrow will **Restore the Default Settings for the settings on this screen**. The text will change between **YES** to **OK** for a few seconds.

### 4.3 LEAD PUMP SWITCH TIME SETUP DISPLAYS

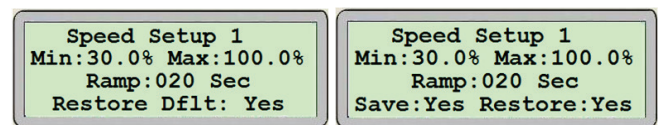

- When the cursor is at the top left corner of the screen, pressing the **UP** or **DOWN** arrow will navigate between the active setup screens of the respective Level.
- Pressing the **ENTER** key will move the cursor over the value beside **SWITCH TIME**, over **YES** beside Save and Restore, and back at the top left corner.
- When the cursor is over the value beside **SWITCH TIME**, pressing the **UP** or **DOWN** key will set the Duty Pump Run Hours Set-point to the desired value. The Standby pump will become the Duty pump after the Duty pump runs for the set amount of time.
- When the cursor is over **YES** beside **SAVE** pressing the **UP** or **DOWN** arrow will **save the settings on this screen as default values**. The text will change between **YES** to **OK** for a few seconds.
- When the cursor is over **YES** beside **RESTORE DFLT** or **RESTORE** pressing the **UP** or **DOWN** arrow will **restore the default settings for the settings on this screen**. The text will change between **YES** to **OK** for a few seconds.

#### 4.4 SPEED SETUP DISPLAYS 1



- When the cursor is at the top left corner of the screen, pressing the **UP** or **DOWN** arrow will navigate between the active setup screens of the respective Level.
- Pressing the **ENTER** key will move the cursor over the value beside **MIN**, over the value beside **MAX**, over the value beside **RAMP**, over **YES** beside **SAVE** and **RESTORE**, and back to the top left corner.
- When the cursor is over the value beside **MIN**, pressing the **UP** or **DOWN** key will set the minimum pump speed set-point to the desired value.
- When the cursor is over the value beside **MAX**, pressing the **UP** or **DOWN** key will set the maximum pump speed set-point to the desired value.
- When the cursor is over the value beside **RAMP**, pressing the **UP** or **DOWN** key will set the pump ramping speed set-point to the desired value. This is the minimum time the pump will take to go from 0% to 100% speed.
- When the cursor is over **YES** beside **SAVE** pressing the **UP** or **DOWN** arrow will **save the settings on this screen as default values**. The text will change between **YES** to **OK** for a few seconds.
- When the cursor is over **YES** beside **RESTORE DFLT** or **RESTORE** pressing the **UP** or **DOWN** arrow will **Restore the Default Settings for the settings on this screen**. The text will change between **YES** to **OK** for a few seconds.

#### 4.5 PLC CLOCK SETUP DISPLAY

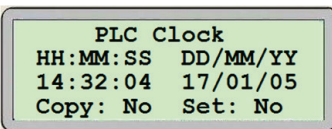

- When the cursor is at the top left corner of the screen, pressing the **UP** or **DOWN** arrow will navigate between the active setup screens of the respective Level.
- Pressing the **ENTER** key will move the cursor below the Time expressed in Hours (HH), Minutes (MM) and Seconds (SS), **HH:MM:SS**, below the Date expressed in Day (DD), Month (MM) and Year (YY), **DD/MM/YY**, over **YES** beside Save and Restore, and back at the top left corner.
- When the cursor is over the number below **HH:MM:SS**, pressing the **UP** or **DOWN** keys will set the Hour (HH), the Minute (MM) and the Second (SS) to the desired values.

- When the cursor is over the number below **DD/MM/YY**, pressing the **UP** or **DOWN** keys will set the Day (DD), the Month (MM) and the Year (YY) to the desired values.
- When the cursor is over **COPY**, pressing the **UP** or **DOWN** keys will copy the current time and date from the PLC to the display. This will overwrite any values previously entered.
- When the cursor is over **SET**, pressing the **UP** or **DOWN** keys will set the entered time and date to the PLC.
- When the cursor is over **YES** beside **SAVE** pressing the **UP** or **DOWN** arrow will **save the settings on this screen as default values**. The text will change between **YES** to **OK** for a few seconds.  
When the cursor is over **YES** beside **RESTORE DFLT** or **RESTORE** pressing the **UP** or **DOWN** arrow will **restore the default settings for the settings on this screen**. The text will change between **YES** to **OK** for a few seconds.

#### 4.6 PUMP PID SETUP DISPLAYS

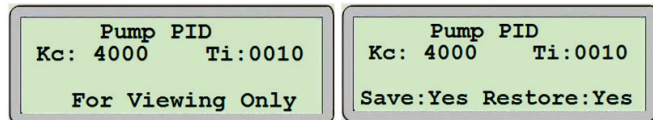

- When the cursor is at the top left corner of the screen, pressing the **UP** or **DOWN** arrow will navigate between the active setup screens of the respective Level.
- Pressing the **ENTER** key will move the cursor over the adjustable fields, over **YES** beside **SAVE** and **RESTORE**, and back at the top left corner.
- When the cursor is over the value beside **Kc**, pressing the **UP** or **DOWN** key will set the PID proportional constant Kc to the desired value.
- When the cursor is over the value beside **Ti**, pressing the **UP** or **DOWN** key will set the PID integral time constant Ti to the desired value.
- When the cursor is over **YES** beside **SAVE** pressing the **UP** or **DOWN** arrow will **save the settings on this screen as default values**. The text will change between **YES** to **OK** for a few seconds.
- When the cursor is over **YES** beside **RESTORE DFLT** or **RESTORE** pressing the **UP** or **DOWN** arrow will **restore the default settings for the settings on this screen**. The text will change between **YES** to **OK** for a few seconds.
- In level 1 this screen is for viewing only.

#### 4.7 BUILDING AUTOMATION SYSTEM (BAS) INTERFACE SETUP DISPLAYS (IF AVAILABLE)

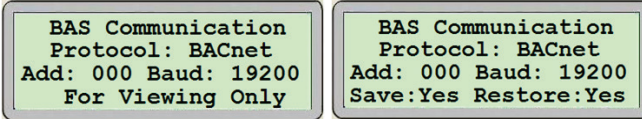

- When the cursor is at the top left corner of the screen, pressing the **UP** or **DOWN** arrow will navigate between the active setup screens of the respective Level.
- Pressing the **ENTER** key will move the cursor over the text beside **PROTOCOL**, the value beside **ADD**, the value beside **BAUD**, over **YES** beside **SAVE** and **RESTORE**, and back at the top left corner.
- When the cursor is over the value beside **PROTOCOL**, pressing the **UP** or **DOWN** key will set the protocol to the desired type. The choices are: Modbus, BACnet and LonWorks.
- When the cursor is over the value beside **ADD**, pressing the **UP** or **DOWN** key will set the node address to the desired value.
- When the cursor is over the value beside **BAUD**, pressing the **UP** or **DOWN** key will set the baud rate to the desired value.
- When the cursor is over **YES** beside **SAVE** pressing the **UP** or **DOWN** arrow will **save the settings on this screen as default values**. The text will change between **YES** to **OK** for a few seconds.
- When the cursor is over **YES** beside **RESTORE DFLT** or **RESTORE** pressing the **UP** or **DOWN** arrow will **restore the default settings for the settings on this screen**. The text will change between **YES** to **OK** for a few seconds.
- In level 1 this screen is for viewing only.

#### 4.8 SYSTEM SENSORLESS SETUP DISPLAYS

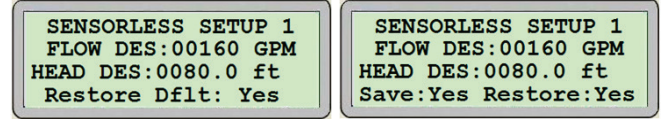

- When the cursor is at the top left corner of the screen, pressing the **UP** or **DOWN** arrow will navigate between the active setup screens of the respective Level.
- Pressing the **ENTER** key will move the cursor over the text beside **FLOW DES**, the flow unit, the value beside **HEAD DES**, the head unit, over **YES** beside **SAVE** and **RESTORE**, and back at the top left corner.
- When the cursor is over the value beside **FLOW DES**, pressing the **UP** or **DOWN** key will set the flow design to the desired value.
- When the cursor is over the flow unit, pressing the **UP** or **DOWN** key will set the flow unit. The choices are: **GPM**, **m<sup>3</sup>/H**, and **LPS**.
- When the cursor is over the value beside **HEAD DES**, pressing the **UP** or **DOWN** key will set the head design to the desired value.
- When the cursor is over the head unit, pressing the **UP** or **DOWN** key will set the head unit. The choices are: **ft**, **bar**, **KPa**, and **psi**.
- When the cursor is over **YES** beside **SAVE** pressing the **UP** or **DOWN** arrow will **save the settings on this screen as default values**. The text will change between **YES** to **OK** for a few seconds.
- When the cursor is over **YES** beside **RESTORE DFLT** or **RESTORE** pressing the **UP** or **DOWN** arrow will **restore the default settings for the settings on this screen**. The text will change between **YES** to **OK** for a few seconds.

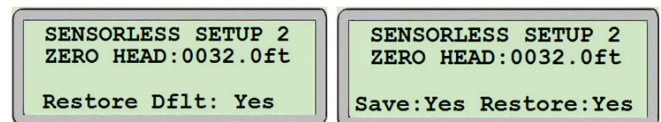

- When the cursor is at the top left corner of the screen, pressing the **UP** or **DOWN** arrow will navigate between the active setup screens of the respective Level.
- Pressing the **ENTER** key will move the cursor over the text beside **ZERO HEAD**, over **YES** beside **SAVE** and **RESTORE**, and back to the top left corner.

- When the cursor is over the value beside **ZERO HEAD**, pressing the **UP** or **DOWN** key will set the zero head to the desired value.
- When the cursor is over **YES** beside **SAVE** pressing the **UP** or **DOWN** arrow will **save the settings on this screen as default values**. The text will change between **YES** to **OK** for a few seconds.
- When the cursor is over **YES** beside **RESTORE DFLT** or **RESTORE** pressing the **UP** or **DOWN** arrow will **restore the default settings for the settings on this screen**. The text will change between **YES** to **OK** for a few seconds.

```
SENSORLESS SETUP 3
FLOW BEP:00136 GPM
HEAD BEP:0090.0 ft
Restore Dflt: Yes
```

```
SENSORLESS SETUP 3
FLOW BEP:00136 GPM
HEAD BEP:0090.0 ft
Save:Yes Restore:Yes
```

- When the cursor is at the top left corner of the screen, pressing the **UP** or **DOWN** arrow will navigate between the active setup screens of the respective Level.
- Pressing the **ENTER** key will move the cursor over the text beside **FLOW BEP**, the value beside **HEAD BEP**, over **YES** beside **SAVE** and **RESTORE**, and back to the top left corner.
- When the cursor is over the value beside **FLOW BEP**, pressing the **UP** or **DOWN** key will set the flow best efficiency point to the desired value.
- When the cursor is over the value beside **HEAD BEP**, pressing the **UP** or **DOWN** key will set the head best efficiency point to the desired value.
- When the cursor is over **YES** beside **SAVE** pressing the **UP** or **DOWN** arrow will **save the settings on this screen as default values**. The text will change between **YES** to **OK** for a few seconds.
- When the cursor is over **YES** beside **RESTORE DFLT** or **RESTORE** pressing the **UP** or **DOWN** arrow will **restore the default settings for the settings on this screen**. The text will change between **YES** to **OK** for a few seconds.

```
SENSORLESS SETUP 4
DEAD BAND:00.5
SENS ADJ:05%
Restore Dflt: Yes
```

```
SENSORLESS SETUP 4
DEAD BAND:00.5
SENS ADJ:05%
Save:Yes Restore:Yes
```

- When the cursor is at the top left corner of the screen, pressing the **UP** or **DOWN** arrow will navigate between the active setup screens of the respective Level.
- Pressing the **ENTER** key will move the cursor over the text beside **DEAD BAND**, the value beside **SENS ADJ**, over **YES** beside **SAVE** and **RESTORE**, and back to the top left corner.
- When the cursor is over the value beside **DEAD BAND**, pressing the **UP** or **DOWN** key will set the dead band (no stage zone around the **BEP**) to the desired value.

- When the cursor is over the value beside **SENS ADJ**, pressing the **UP** or **DOWN** key will set the sensorless adjustment (compensation when outside sensorless map range) to the desired value.
- When the cursor is over **YES** beside **SAVE** pressing the **UP** or **DOWN** arrow will **save the settings on this screen as default values**. The text will change between **YES** to **OK** for a few seconds.
- When the cursor is over **YES** beside **RESTORE DFLT** or **RESTORE** pressing the **UP** or **DOWN** arrow will **restore the default settings for the settings on this screen**. The text will change between **YES** to **OK** for a few seconds.

#### 4.9 SYSTEM SENSORLESS SETUP DISPLAYS

```
VFD FACTORS 1
AMPS:1 kW:1
VOLTS:1
Restore Dflt: Yes
```

```
VFD FACTORS 1
AMPS:1 kW:1
VOLTS:1
Save:Yes Restore:Yes
```

- When the cursor is at the top left corner of the screen, pressing the **UP** or **DOWN** arrow will navigate between the active setup screens of the respective Level.
- Pressing the **ENTER** key will move the cursor over the text beside **AMPS**, the value beside **kWs**, the value beside **VOLTS**, over **YES** beside **SAVE** and **RESTORE**, and back to the top left corner.
- When the cursor is over the value beside **AMPS**, pressing the **UP** or **DOWN** key will set the multiplication factor to display the correct amperage from the drive.
- When the cursor is over the value beside **kWs**, pressing the **UP** or **DOWN** key will set the multiplication factor to display the correct kilo-watts from the drive.
- When the cursor is over the value beside **VOLTS**, pressing the **UP** or **DOWN** key will set the multiplication factor to display the correct voltage from the drive.
- When the cursor is over **YES** beside **SAVE** pressing the **UP** or **DOWN** arrow will **save the settings on this screen as default values**. The text will change between **YES** to **OK** for a few seconds.
- When the cursor is over **YES** beside **RESTORE DFLT** or **RESTORE** pressing the **UP** or **DOWN** arrow will **restore the default settings for the settings on this screen**. The text will change between **YES** to **OK** for a few seconds.

```
VFD FACTORS 2
HEAD:0.1 FLOW:1
Restore Dflt: Yes
```

```
VFD FACTORS 2
HEAD:0.1 FLOW:1
Save:Yes Restore:Yes
```

- When the cursor is at the top left corner of the screen, pressing the **UP** or **DOWN** arrow will navigate between the active setup screens of the respective Level.
- Pressing the **ENTER** key will move the cursor over the text beside **HEAD**, the value beside **FLOW**, over **YES** beside **SAVE** and **RESTORE**, and back at the top left corner.
- When the cursor is over the value beside **HEAD**, pressing the **UP** or **DOWN** key will set the multiplication factor to display the correct head from the drive.
- When the cursor is over the value beside **FLOW**, pressing the **UP** or **DOWN** key will set the multiplication factor to display the correct flow from the drive.
- When the cursor is over **YES** beside **SAVE** pressing the **UP** or **DOWN** arrow will **save the settings on this screen as default values**. The text will change between **YES** to **OK** for a few seconds.
- When the cursor is over **YES** beside **RESTORE DFLT** or **RESTORE** pressing the **UP** or **DOWN** arrow will **restore the default settings for the settings on this screen**. The text will change between **YES** to **OK** for a few seconds.

## 5.0 DATA POINTS FOR PARALLEL SENSORLESS PUMP CONTROLLER

### 5.1 SUMMARY

PARAMETERS TO BE DISPLAYED ON CONTROLLER		
SYSTEM STATUS	INDIVIDUAL PUMP STATUS	INDIVIDUAL IVS102 STATUS
Total Sensorless flow	Speed Ref (%)	Current (Amps)
Sensorless head	Speed (%) (RPM)	Volt (VAC)
Total power	Run time (hrs)	Power (kW)
Pumps speed	Fault Num	Head
Alarm	Run status (running/stopped)	Flow
Wire to water efficiency (calculated)		
Number of pumps running		
Lead pump number		

PARAMETERS TO BE SET		
FROM BAS OR CONTROLLER	FROM CONTROLLER	IVS102 READOUT FACTORS
Number of pumps	Number of standby pumps	Amps
Lead pump switch time (HRS)	Speed maximum ramp time (s)	Volts
Flow - design	Pump minimum speed (%)	kW
Head - design	Pump maximum speed (%)	Flow
Head zero flow ( $H_{min}$ )	Motor rated speed (RPM)	Head
Flow - BEP	Hz	
Head - BEP	PID gain (Kc)	
Dead band	PID integral (Ti)	
Sensorless adjustment	BAS protocol (option)	
Enable signal to controller	BAS address (option)	
	BAS baud rate (option)	
	Head unit	
	Flow unit	



## 5.2 BAS DATA POINTS - MODBUS RTU

### BUILDING AUTOMATION SYSTEM

Parallel Sensorless Modbus RTU - Communication interface Rev 13031

MODBUS ADDRESS	SIGNAL TYPE	READ/WRITE	DESCRIPTION	RANGE	REPRESENT	UNITS
552	Digital	R/W	Set pump 1 hand		Hand	Momentary
553	Digital	R/W	Set pump 1 off		Off	Momentary
554	Digital	R/W	Set pump 1 auto		Auto	Momentary
555	Digital	R/W	Set pump 2 hand		Hand	Momentary
556	Digital	R/W	Set pump 2 off		Off	Momentary
557	Digital	R/W	Set pump 2 auto		Auto	Momentary
558	Digital	R/W	Set pump 3 hand		Hand	Momentary
559	Digital	R/W	Set pump 3 off		Off	Momentary
560	Digital	R/W	Set pump 3 auto		Auto	Momentary
561	Digital	R/W	Set pump 4 hand		Hand	Momentary
562	Digital	R/W	Set pump 4 off		Off	Momentary
563	Digital	R/W	Set pump 4 auto		Auto	Momentary
564	Digital	R/W	Reserved			
565	Digital	R/W	Reserved			
566	Digital	R/W	Reserved			
567	Digital	R/W	Reserved			
568	Digital	R/W	Reserved			
569	Digital	R/W	Reserved			
570	Digital	R/W	Reserved			
571	Digital	R/W	Reserved			
572	Digital	R/W	Reserved			
573	Digital	R/W	Reserved			
574	Digital	R/W	Reserved			
575	Digital	R/W	Reserved			
576	Digital	R/W	Reserved			
577	Digital	R/W	Reserved			
578	Digital	R/W	Reserved			
579	Digital	R/W	Reserved			
580	Digital	R/W	Reserved			
581	Digital	R/W	Reserved			
582	Digital	R/W	Reserved			
583	Digital	R/W	Set alarm reset		Reset	Momentary

MODBUS ADDRESS	SIGNAL TYPE	READ/WRITE	DESCRIPTION	OFF STATE (0)	ON STATE (1)	TYPE
10401	Digital	R	System alarm	Ok	Alarm	Toggle
10402	Digital	R				
10403	Digital	R	Pump alarm	Ok	Alarm	Toggle
10404	Digital	R	Pump 1 in hand mode		Hand	Toggle
10405	Digital	R	Pump 1 in off mode		Off	Toggle
10406	Digital	R	Pump 1 in auto mode		Auto	Toggle
10407	Digital	R	Pump 2 in hand mode		Hand	Toggle
10408	Digital	R	Pump 2 in off mode		Off	Toggle
10409	Digital	R	Pump 2 in auto mode		Auto	Toggle
10410	Digital	R	Pump 3 in hand mode		Hand	Toggle
10411	Digital	R	Pump 3 in off mode		Off	Toggle
10412	Digital	R	Pump 3 in auto mode		Auto	Toggle
10413	Digital	R	Pump 4 in hand mode		Hand	Toggle
10414	Digital	R	Pump 4 in off mode		Off	Toggle
10415	Digital	R	Pump 4 in auto mode		Auto	Toggle
10416	Digital	R	Reserved			
10417	Digital	R	Reserved			
10418	Digital	R	Reserved			
10419	Digital	R	Reserved			
10420	Digital	R	Reserved			
10421	Digital	R	Reserved			
10422	Digital	R	Reserved			
10423	Digital	R	Reserved			
10424	Digital	R	Reserved			
10425	Digital	R	Reserved			
10426	Digital	R	Reserved			
10427	Digital	R	Reserved			
10428	Digital	R	Reserved			
10429	Digital	R	Reserved			
10430	Digital	R	Reserved			
10431	Digital	R	Reserved			
10432	Digital	R	Reserved			
10433	Digital	R	Reserved			
10434	Digital	R	Pump 1 run feedback	Stopped	Running	Toggle
10435	Digital	R	Pump 2 run feedback	Stopped	Running	Toggle
10436	Digital	R	Pump 3 run feedback	Stopped	Running	Toggle
10437	Digital	R	Pump 4 run feedback	Stopped	Running	Toggle
10438	Digital	R	Reserved			
10439	Digital	R	Reserved			
10440	Digital	R	Reserved			
10441	Digital	R	Reserved			
10442	Digital	R	Reserved			
10443	Digital	R	Reserved			

MODBUS ADDRESS	SIGNAL TYPE	READ/WRITE	DESCRIPTION	OFF STATE (0)	ON STATE (1)	TYPE
10444	Digital	R	Reserved			
10445	Digital	R	Reserved			
10446	Digital	R	Reserved			
10447	Digital	R	Reserved			
10448	Digital	R	Reserved			
10449	Digital	R	Reserved			
10450	Digital	R	Reserved			
10451	Digital	R	Reserved			
10452	Digital	R	Reserved			
10453	Digital	R	Reserved			
10454	Digital	R	Reserved			
10455	Digital	R	Reserved			
10456	Digital	R	Reserved			
10457	Digital	R	Reserved			
10458	Digital	R	Reserved			
10459	Digital	R	Reserved			
10460	Digital	R	Reserved			
10461	Digital	R	Reserved			
10462	Digital	R	Reserved			
10463	Digital	R	Reserved			
10464	Digital	R	Reserved			
10465	Digital	R	Reserved			
10466	Digital	R	Reserved			
10467	Digital	R	Reserved			
10468	Digital	R	Pump 1 alarm	Ok	Alarm	Toggle
10469	Digital	R	Pump 2 alarm	Ok	Alarm	Toggle
10470	Digital	R	Pump 3 alarm	Ok	Alarm	Toggle
10471	Digital	R	Pump 4 alarm	Ok	Alarm	Toggle
10472	Digital	R	Reserved			
10473	Digital	R	Reserved			
10474	Digital	R	Reserved			
10475	Digital	R	Reserved			
10476	Digital	R	Reserved			
10477	Digital	R	Reserved			
10478	Digital	R	Pump 1 run feedback alarm	Ok	Alarm	Toggle
10479	Digital	R	Pump 2 run feedback alarm	Ok	Alarm	Toggle
10480	Digital	R	Pump 3 run feedback alarm	Ok	Alarm	Toggle
10481	Digital	R	Pump 4 run feedback alarm	Ok	Alarm	Toggle
10482	Digital	R	Reserved			
10483	Digital	R	Reserved			
10484	Digital	R	Reserved			

MODBUS ADDRESS	SIGNAL TYPE	READ/WRITE	DESCRIPTION	OFF STATE (0)	ON STATE (1)	TYPE
10485	Digital	R	Reserved			
10486	Digital	R	Reserved			
10487	Digital	R	Reserved			
10488	Digital	R	Pump 1 drive fault	Ok	Alarm	Toggle
10489	Digital	R	Pump 2 drive fault	Ok	Alarm	Toggle
10490	Digital	R	Pump 3 drive fault	Ok	Alarm	Toggle
10491	Digital	R	Pump 4 drive fault	Ok	Alarm	Toggle
10492	Digital	R	Reserved			
10493	Digital	R	Reserved			
10494	Digital	R	Reserved			
10495	Digital	R	Reserved			
10496	Digital	R	Reserved			
10497	Digital	R	Reserved			
10498	Digital	R	Reserved			
10499	Digital	R	Reserved			
10500	Digital	R	Reserved			
10501	Digital	R	Reserved			
10502	Digital	R	Reserved			
10503	Digital	R	Reserved			
10504	Digital	R	Reserved			
10505	Digital	R	Reserved			
10506	Digital	R	Reserved			
10507	Digital	R	Reserved			
10508	Digital	R	Reserved			
10509	Digital	R	Reserved			
10510	Digital	R	Reserved			
10511	Digital	R	Reserved			
10512	Digital	R	Reserved			
10513	Digital	R	Reserved			
10514	Digital	R	Reserved			
10515	Digital	R	Reserved			
10516	Digital	R	Reserved			
10517	Digital	R	Reserved			
10518	Digital	R	Reserved			
10519	Digital	R	Reserved			

MODBUS ADDRESS	SIGNAL TYPE	READ/WRITE	DESCRIPTION	RANGE	REPRESENT	UNITS
30401	Analog	R	Reserved			
30402	Analog	R	Reserved			
30403	Analog	R	Reserved			
30404	Analog	R	Reserved			
30405	Analog	R	Reserved			
30406	Analog	R	Reserved			
30407	Analog	R	Reserved			
30408	Analog	R	Reserved			
30409	Analog	R	Reserved			
30410	Analog	R	Reserved			
30411	Analog	R	Reserved			
30412	Analog	R	Reserved			
30413	Analog	R	Reserved			
30414	Analog	R	Reserved			
30415	Analog	R	Reserved			
30416	Analog	R	Reserved			
30417	Analog	R	Reserved			
30418	Analog	R	Reserved			
30419	Analog	R	Reserved			
30420	Analog	R	Reserved			
30421	Analog	R	Reserved			
30422	Analog	R	Reserved			
30423	Analog	R	Reserved			
30424	Analog	R	Reserved			
30425	Analog	R	Reserved			
30426	Analog	R	Reserved			
30427	Analog	R	Reserved			
30428	Analog	R	Reserved			
30429	Analog	R	Reserved			
30430	Analog	R	Reserved			
30431	Analog	R	Reserved			
30432	Analog	R	Reserved			
30433	Analog	R	Reserved			
30434	Analog	R	Reserved			
30435	Analog	R	Reserved			
30436	Analog	R	Reserved			
30437	Analog	R	Reserved			
30438	Analog	R	Reserved			
30439	Analog	R	Reserved			

MODBUS ADDRESS	SIGNAL TYPE	READ/WRITE	DESCRIPTION	RANGE	REPRESENT	UNITS
30440	Analog	R	Pump 1 speed	0 to 1000	0.0 to 100.0	%
30441	Analog	R	Pump 2 speed			
30442	Analog	R	Pump 3 speed			
30443	Analog	R	Pump 4 speed			
30444	Analog	R	Reserved			
30445	Analog	R	Reserved			
30446	Analog	R	Reserved			
30447	Analog	R	Reserved			
30448	Analog	R	Reserved			
30449	Analog	R	Reserved			
30450	Analog	R	Reserved			
30451	Analog	R	Reserved			
30452	Analog	R	Total head	0 to 32767	0 to 3276.7	ft, psi, kPa
30453	Analog	R	Pump 1 drive amp	0 to 10000	0.0 to 1000.0	Amp
30454	Analog	R	Pump 1 drive volt AC			VAC
30455	Analog	R	Pump 1 drive power			kW
30456	Analog	R	Pump 1 drive speed feedback	0 to 1000	0.0 to 100.0	%
30457	Analog	R	Pump 2 drive amp	0 to 10000	0.0 to 1000.0	Amp
30458	Analog	R	Pump 2 drive volt AC			VAC
30459	Analog	R	Pump 2 drive power			kW
30460	Analog	R	Pump 2 drive speed feedback	0 to 1000	0.0 to 100.0	%
30461	Analog	R	Pump 3 drive amp	0 to 10000	0.0 to 1000.0	Amp
30462	Analog	R	Pump 3 drive volt AC			VAC
30463	Analog	R	Pump 3 drive power			kW
30464	Analog	R	Pump 3 drive speed feedback	0 to 1000	0.0 to 100.0	%
30465	Analog	R	Pump 4 drive amp	0 to 10000	0.0 to 1000.0	Amp
30466	Analog	R	Pump 4 drive volt AC			VAC
30467	Analog	R	Pump 4 drive power			kW
30468	Analog	R	Pump 4 drive speed feedback	0 to 1000	0.0 to 100.0	%
30469	Analog	R	Reserved			
30470	Analog	R	Reserved			
30471	Analog	R	Reserved			
30472	Analog	R	Reserved			
30473	Analog	R	Reserved			
30474	Analog	R	Reserved			
30475	Analog	R	Reserved			
30476	Analog	R	Reserved			
30477	Analog	R	Reserved			
30478	Analog	R	Reserved			
30479	Analog	R	Reserved			
30480	Analog	R	Reserved			

MODBUS ADDRESS	SIGNAL TYPE	READ/WRITE	DESCRIPTION	RANGE	REPRESENT	UNITS
30481	Analog	R	Reserved			
30482	Analog	R	Reserved			
30483	Analog	R	Reserved			
30484	Analog	R	Reserved			
30485	Analog	R	Reserved			
30486	Analog	R	Reserved			
30487	Analog	R	Reserved			
30488	Analog	R	Reserved			
30489	Analog	R	Reserved			
30490	Analog	R	Reserved			
30491	Analog	R	Reserved			
30492	Analog	R	Reserved			
30493	Analog	R	Pump 1 head	0 to 32767	0.0 to 3276.7	ft, psi, kPa
30494	Analog	R	Pump 2 head			
30495	Analog	R	Pump 3 head			
30496	Analog	R	Pump 4 head			
30497	Analog	R	Reserved			
30498	Analog	R	Reserved			
30499	Analog	R	Reserved			
30500	Analog	R	Reserved			
30501	Analog	R	Reserved			
30502	Analog	R	Reserved			
30503	Analog	R	W to W efficiency	0 to 32767	0.0 to 3276.7	
30504	Analog	R	Total drive kW	0 to 32767	0.0 to 3276.7	
35401	Analog	R	Reserved			
35402	Analog	R	Reserved			
35403	Analog	R	Pump 1 flow	0 to 32767	0 to 32767	gpm, lps, m3/hr
35404	Analog	R	Pump 2 flow			
35405	Analog	R	Pump 3 flow			
35406	Analog	R	Pump 4 flow			
35407	Analog	R	Reserved			
35408	Analog	R	Reserved			
35409	Analog	R	Reserved			
35410	Analog	R	Reserved			
35411	Analog	R	Reserved			
35412	Analog	R	Reserved			
35413	Analog	R	Total Flow	0 to 32767	0 to 327670	gpm
35414	Analog	R	Pump 1 operating run hours		0 to 999	Hrs
35415	Analog	R	Pump 1 operating run khours		0 to 32000	Hrs x1000
35416	Analog	R	Pump 2 operating run hours		0 to 999	Hrs
35417	Analog	R	Pump 2 operating run khours		0 to 32000	Hrs x1000

MODBUS ADDRESS	SIGNAL TYPE	READ/WRITE	DESCRIPTION	RANGE	REPRESENT	UNITS
35418	Analog	R	Pump 3 operating run hours		0 to 999	Hrs
35419	Analog	R	Pump 3 operating run khours		0 to 32000	Hrs x1000
35420	Analog	R	Pump 4 operating run hours		0 to 999	Hrs
35421	Analog	R	Pump 4 operating run khours		0 to 32000	Hrs x1000
35422	Analog	R	Reserved			
35423	Analog	R	Reserved			
35424	Analog	R	Reserved			
35425	Analog	R	Reserved			
35426	Analog	R	Reserved			
35427	Analog	R	Reserved			
35428	Analog	R	Reserved			
35429	Analog	R	Reserved			
35430	Analog	R	Reserved			
35431	Analog	R	Reserved			
35432	Analog	R	Reserved			
35433	Analog	R	Number of pump running		0 to 4	
35434	Analog	R	Lead pump ID		0 to 4	
40551	Analog	R/W	Reserved			
40552	Analog	R/W	Reserved			
40553	Analog	R/W	Reserved			
40554	Analog	R/W	Reserved			
40555	Analog	R/W	Reserved			
40556	Analog	R/W	Reserved			
40557	Analog	R/W	Reserved			
40558	Analog	R/W	Reserved			
40559	Analog	R/W	Reserved			
40560	Analog	R/W	Reserved			
40561	Analog	R/W	Reserved			
40562	Analog	R/W	Reserved			
40563	Analog	R/W	Reserved			
40564	Analog	R/W	Reserved			
40565	Analog	R/W	Reserved			
40566	Analog	R/W	Reserved			
40567	Analog	R/W	Reserved			
40568	Analog	R/W	Reserved			
40569	Analog	R/W	Pump 1 hand speed	0 to 1000	0.0 to 100.0	%
40570	Analog	R/W	Pump 2 hand speed			
40571	Analog	R/W	Pump 3 hand speed			
40572	Analog	R/W	Pump 4 hand speed			
40573	Analog	R/W	Reserved			



MODBUS ADDRESS	SIGNAL TYPE	READ/WRITE	DESCRIPTION	RANGE	REPRESENT	UNITS
40574	Analog	R/W	Reserved			
40575	Analog	R/W	Reserved			
40576	Analog	R/W	Reserved			
40577	Analog	R/W	Reserved			
40578	Analog	R/W	Reserved			
40579	Analog	R/W	Reserved			
40580	Analog	R/W	Design flow	0 to 9999	0.0 to 9999	gpm
40581	Analog	R/W	Design head	0 to 9999	0.0 to 999.9	ft, psi, bar
40582	Analog	R/W	Zero flow head			
40583	Analog	R/W	Flow BEP	0 to 9999	0.0 to 9999	gpm
40584	Analog	R/W	Head BEP	0 to 9999	0.0 to 999.9	ft,psi,bar
40585	Analog	R/W	Dead Band	0 to 5	0 to 0.5	
40586	Analog	R/W	Sensorless map factor	0 to 5	0 to 5	%
40587	Analog	R/W	Number of pumps	0 to 6	0 to 6	
40588	Analog	R/W	Lead pump switch time	0 to 99	0 to 99	Days
40589	Analog	R/W	Reserved			
40590	Analog	R/W	Reserved			
40591	Analog	R/W	Reserved			
40592	Analog	R/W	Reserved			
40593	Analog	R/W	Reserved			
40594	Analog	R/W	Reserved			
40595	Analog	R/W	Reserved			
40596	Analog	R/W	Reserved			

### 5.3 BAS DATA POINTS - BACNET

#### BUILDING AUTOMATION SYSTEM - BACNET MSTP

Parallel Sensorless communication interface Rev 13031 (Device ID: 77000)

SIGNAL TYPE	INSTANCE	NAME	DESCRIPTION	OFF STATE (0)	ON STATE (1)	TYPE
DO	400	D400	System alarm	Ok	Alarm	Toggle
DO	401	D401	Reserved			
DO	402	D402	Pump alarm	Ok	Alarm	Toggle
DO	403	D403	Pump 1 in hand mode		Hand	Toggle
DO	404	D404	Pump 1 in off mode		Off	Toggle
DO	405	D405	Pump 1 in auto mode		Auto	Toggle
DO	406	D406	Pump 2 in hand mode		Hand	Toggle
DO	407	D407	Pump 2 in off mode		Off	Toggle
DO	408	D408	Pump 2 in auto mode		Auto	Toggle
DO	409	D409	Pump 3 in hand mode		Hand	Toggle
DO	410	D410	Pump 3 in off mode		Off	Toggle
DO	411	D411	Pump 3 in auto mode		Auto	Toggle
DO	412	D412	Pump 4 in hand mode		Hand	Toggle
DO	413	D413	Pump 4 in off mode		Off	Toggle
DO	414	D414	Pump 4 in auto mode		Auto	Toggle
DO	415	D415	Reserved			
DO	416	D416	Reserved			
DO	417	D417	Reserved			
DO	418	D418	Reserved			
DO	419	D419	Reserved			
DO	420	D420	Reserved			
DO	421	D421	Reserved			
DO	422	D422	Reserved			
DO	423	D423	Reserved			
DO	424	D424	Reserved			
DO	425	D425	Reserved			
DO	426	D426	Reserved			
DO	427	D427	Reserved			
DO	428	D428	Reserved			
DO	429	D429	Reserved			
DO	430	D430	Reserved			
DO	431	D431	Reserved			
DO	432	D432	Reserved			
DO	433	D433	Pump 1 run feedback	Stopped	Running	Toggle
DO	434	D434	Pump 2 run feedback	Stopped	Running	Toggle
DO	435	D435	Pump 3 run feedback	Stopped	Running	Toggle
DO	436	D436	Pump 4 run feedback	Stopped	Running	Toggle
DO	437	D437	Reserved			
DO	438	D438	Reserved			

SIGNAL TYPE	INSTANCE	NAME	DESCRIPTION	OFF STATE (0)	ON STATE (1)	TYPE
DO	439	D439	Reserved			
DO	440	D440	Reserved			
DO	441	D441	Reserved			
DO	442	D442	Reserved			
DO	443	D443	Reserved			
DO	444	D444	Reserved			
DO	445	D445	Reserved			
DO	446	D446	Reserved			
DO	447	D447	Reserved			
DO	448	D448	Reserved			
DO	449	D449	Reserved			
DO	450	D450	Reserved			
DO	451	D451	Reserved			
DO	452	D452	Reserved			
DO	453	D453	Reserved			
DO	454	D454	Reserved			
DO	455	D455	Reserved			
DO	456	D456	Reserved			
DO	457	D457	Reserved			
DO	458	D458	Reserved			
DO	459	D459	Reserved			
DO	460	D460	Reserved			
DO	461	D461	Reserved			
DO	462	D462	Reserved			
DO	463	D463	Reserved			
DO	464	D464	Reserved			
DO	465	D465	Reserved			
DO	466	D466	Reserved			
DO	467	D467	Pump 1 alarm	Ok	Alarm	Toggle
DO	468	D468	Pump 2 alarm	Ok	Alarm	Toggle
DO	469	D469	Pump 3 alarm	Ok	Alarm	Toggle
DO	470	D470	Pump 4 alarm	Ok	Alarm	Toggle
DO	471	D471	Reserved			
DO	472	D472	Reserved			
DO	473	D473	Reserved			
DO	474	D474	Reserved			
DO	475	D475	Reserved			
DO	476	D476	Reserved			
DO	477	D477	Pump 1 run feedback alarm	Ok	Alarm	Toggle
DO	478	D478	Pump 2 run feedback alarm	Ok	Alarm	Toggle
DO	479	D479	Pump 3 run feedback alarm	Ok	Alarm	Toggle

SIGNAL TYPE	INSTANCE	NAME	DESCRIPTION	OFF STATE (0)	ON STATE (1)	TYPE
DO	480	D480	Pump 4 run feedback alarm	Ok	Alarm	Toggle
DO	481	D481	Reserved			
DO	482	D482	Reserved			
DO	483	D483	Reserved			
DO	484	D484	Reserved			
DO	485	D485	Reserved			
DO	486	D486	Reserved			
DO	487	D487	Pump 1 drive fault	Ok	Alarm	Toggle
DO	488	D488	Pump 2 drive fault	Ok	Alarm	Toggle
DO	489	D489	Pump 3 drive fault	Ok	Alarm	Toggle
DO	490	D490	Pump 4 drive fault	Ok	Alarm	Toggle
DO	491	D491	Reserved			
DO	492	D492	Reserved			
DO	493	D493	Reserved			
DO	494	D494	Reserved			
DO	495	D495	Reserved			
DO	496	D496	Reserved			
DO	497	D497	Reserved			
DO	498	D498	Reserved			
DO	499	D499	Reserved			
DO	500	D500	Reserved			
DO	501	D501	Reserved			
DO	502	D502	Reserved			
DO	503	D503	Reserved			
DO	504	D504	Reserved			
DO	505	D505	Reserved			
DO	506	D506	Reserved			
DO	507	D507	Reserved			
DO	508	D508	Reserved			
DO	509	D509	Reserved			
DO	510	D510	Reserved			
DO	511	D511	Reserved			
DO	512	D512	Reserved			
DO	513	D513	Reserved			
DO	514	D514	Reserved			
DO	515	D515	Reserved			
DO	516	D516	Reserved			
DO	517	D517	Reserved			
DO	518	D518	Reserved			

SIGNAL TYPE	INSTANCE	NAME	DESCRIPTION	RANGE	REPRESENT	UNITS
DI	550	D550	Remote start	Stop	Start	Toggle
DI	551	D551	Set pump 1 hand		Hand	Momentary
DI	552	D552	Set pump 1 off		Off	Momentary
DI	553	D553	Set pump 1 auto		Auto	Momentary
DI	554	D554	Set pump 2 hand		Hand	Momentary
DI	555	D555	Set pump 2 off		Off	Momentary
DI	556	D556	Set pump 2 auto		Auto	Momentary
DI	557	D557	Set pump 3 hand		Hand	Momentary
DI	558	D558	Set pump 3 off		Off	Momentary
DI	559	D559	Set pump 3 auto		Auto	Momentary
DI	560	D560	Set pump 4 hand		Hand	Momentary
DI	561	D561	Set pump 4 off		Off	Momentary
DI	562	D562	Set pump 4 auto		Auto	Momentary
DI	563	D563	Reserved			
DI	564	D564	Reserved			
DI	565	D565	Reserved			
DI	566	D566	Reserved			
DI	567	D567	Reserved			
DI	568	D568	Reserved			
DI	569	D569	Reserved			
DI	570	D570	Reserved			
DI	571	D571	Reserved			
DI	572	D572	Reserved			
DI	573	D573	Reserved			
DI	574	D574	Reserved			
DI	575	D575	Reserved			
DI	576	D576	Reserved			
DI	577	D577	Reserved			
DI	578	D578	Reserved			
DI	579	D579	Reserved			
DI	580	D580	Reserved			
DI	581	D581	Reserved			
DI	582	D582	Set alarm reset		Reset	Momentary
AO	400	A0400	Reserved			
AO	401	A0401	Reserved			
AO	402	A0402	Reserved			
AO	403	A0403	Reserved			
AO	404	A0404	Reserved			
AO	405	A0405	Reserved			
AO	406	A0406	Reserved			
AO	407	A0407	Reserved			
AO	408	A0408	Reserved			
AO	409	A0409	Reserved			

SIGNAL TYPE	INSTANCE	NAME	DESCRIPTION	RANGE	REPRESENT	UNITS
AO	410	AO410	Reserved			
AO	411	AO411	Reserved			
AO	412	AO412	Reserved			
AO	413	AO413	Reserved			
AO	414	AO414	Reserved			
AO	415	AO415	Reserved			
AO	416	AO416	Reserved			
AO	417	AO417	Reserved			
AO	418	AO418	Reserved			
AO	419	AO419	Reserved			
AO	420	AO420	Reserved			
AO	421	AO421	Reserved			
AO	422	AO422	Reserved			
AO	423	AO423	Reserved			
AO	424	AO424	Reserved			
AO	425	AO425	Reserved			
AO	426	AO426	Reserved			
AO	427	AO427	Reserved			
AO	428	AO428	Reserved			
AO	429	AO429	Reserved			
AO	430	AO430	Reserved			
AO	431	AO431	Reserved			
AO	432	AO432	Reserved			
AO	433	AO433	Reserved			
AO	434	AO434	Reserved			
AO	435	AO435	Reserved			
AO	436	AO436	Reserved			
AO	437	AO437	Reserved			
AO	438	AO438	Reserved			
AO	439	AO439	Pump 1 speed	0 to 1000	0.0 to 100.0	%
AO	440	AO440	Pump 2 speed			
AO	441	AO441	Pump 3 speed			
AO	442	AO442	Pump 4 speed			
AO	443	AO443	Reserved			
AO	444	AO444	Reserved			
AO	445	AO445	Reserved			
AO	446	AO446	Reserved			
AO	447	AO447	Reserved			
AO	448	AO448	Reserved			
AO	449	AO449	Reserved			
AO	450	AO450	Reserved			
AO	451	AO451	Total head	0 to 32767	0 to 3276.7	ft, psi, kPa

SIGNAL TYPE	INSTANCE	NAME	DESCRIPTION	RANGE	REPRESENT	UNITS
AO	452	AO452	Pump 1 drive amp	0 to 10000	0.0 to 1000.0	Amp
AO	453	AO453	Pump 1 drive volt AC			VAC
AO	454	AO454	Pump 1 drive power			kW
AO	455	AO455	Pump 1 drive speed feedback	0 to 1000	0.0 to 100.0	%
AO	456	AO456	Pump 2 drive amp	0 to 10000	0.0 to 1000.0	Amp
AO	457	AO457	Pump 2 drive volt AC			VAC
AO	458	AO458	Pump 2 drive power			kW
AO	459	AO459	Pump 2 drive speed feedback	0 to 1000	0.0 to 100.0	%
AO	460	AO460	Pump 3 drive amp	0 to 10000	0.0 to 1000.0	Amp
AO	461	AO461	Pump 3 drive volt AC			VAC
AO	462	AO462	Pump 3 drive power			kW
AO	463	AO463	Pump 3 drive speed feedback	0 to 1000	0.0 to 100.0	%
AO	464	AO464	Pump 4 drive amp	0 to 10000	0.0 to 1000.0	Amp
AO	465	AO465	Pump 4 drive volt AC			VAC
AO	466	AO466	Pump 4 drive power			kW
AO	467	AO467	Pump 4 drive speed feedback	0 to 1000	0.0 to 100.0	%
AO	468	AO468	Reserved			
AO	469	AO469	Reserved			
AO	470	AO470	Reserved			
AO	471	AO471	Reserved			
AO	472	AO472	Reserved			
AO	473	AO473	Reserved			
AO	474	AO474	Reserved			
AO	475	AO475	Reserved			
AO	476	AO476	Reserved			
AO	477	AO477	Reserved			
AO	478	AO478	Reserved			
AO	479	AO479	Reserved			
AO	480	AO480	Reserved			
AO	481	AO481	Reserved			
AO	482	AO482	Reserved			
AO	483	AO483	Reserved			
AO	484	AO484	Reserved			
AO	485	AO485	Reserved			
AO	486	AO486	Reserved			
AO	487	AO487	Reserved			
AO	488	AO488	Reserved			
AO	489	AO489	Reserved			
AO	490	AO490	Reserved			
AO	491	AO491	Reserved			
AO	492	AO492	Pump 1 head	0 to 32767	0 to 3276.7	ft, psi, kPa
AO	493	AO493	Pump 2 head			
AO	494	AO494	Pump 3 head			
AO	495	AO495	Pump 4 head			

SIGNAL TYPE	INSTANCE	NAME	DESCRIPTION	RANGE	REPRESENT	UNITS
AO	496	A0496	Reserved			
AO	497	A0497	Reserved			
AO	498	A0498	Reserved			
AO	499	A0499	Reserved			
AO	500	A0500	Reserved			
AO	501	A0501	Reserved			
AO	502	A0502	W to W efficiency	0 to 32767	0.0 to 3276.7	
AO	503	A0503	Total drive kW			
AI	551	A0551	Reserved			
AI	552	A0552	Reserved			
AI	553	A0553	Reserved			
AI	554	A0554	Reserved			
AI	555	A0555	Reserved			
AI	556	A0556	Reserved			
AI	557	A0557	Reserved			
AI	558	A0558	Reserved			
AI	559	A0559	Reserved			
AI	560	A0560	Reserved			
AI	561	A0561	Reserved			
AI	562	A0562	Reserved			
AI	563	A0563	Reserved			
AI	564	A0564	Reserved			
AI	565	A0565	Reserved			
AI	566	A0566	Reserved			
AI	567	A0567	Reserved			
AI	568	A0568	Reserved			
AI	569	A0569	Pump 1 hand speed	0 to 1000	0.0 to 100.0	%
AI	570	A0570	Pump 2 hand speed			
AI	571	A0571	Pump 3 hand speed			
AI	572	A0572	Pump 4 hand speed			
AI	573	A0573	Reserved			
AI	574	A0574	Reserved			
AI	575	A0575	Reserved			
AI	576	A0576	Reserved			
AI	577	A0577	Reserved			
AI	578	A0578	Reserved			
AI	579	A0579	Reserved			
AI	580	A0580	Design flow	0 to 9999	0.0 to 9999	gpm
AI	581	A0581	Design head	0 to 9999	0.0 to 999.9	ft, psi, bar
AI	582	A0582	Zero flow head			
AI	583	A0583	Flow BEP	0 to 9999	0.0 to 9999	gpm
AI	584	A0584	Head BEP	0 to 9999	0.0 to 999.9	ft, psi, bar
AI	585	A0585	Dead band	0 to 5	0 to 0.5	



SIGNAL TYPE	INSTANCE	NAME	DESCRIPTION	RANGE	REPRESENT	UNITS
AI	586	A0586	Sensorless map factor	0 to 5	0 to 5	%
AI	587	A0587	Reserved			
AI	588	A0588	Reserved			
AI	589	A0589	Reserved			
AI	590	A0590	Reserved			
AI	591	A0591	Reserved			
AI	592	A0592	Reserved			
AI	593	A0593	Reserved			
AI	594	A0594	Reserved			
AI	595	A0595	Reserved			
AI	596	A0596	Reserved			
AO	5408	A5408	Reserved			
AO	5409	A5409	Reserved			
AO	5410	A5410	Reserved			
AO	5411	A5411	Reserved			
AO	5412	A5412	Total Flow	0 to 32767	0 to 327670	gpm
AO	5413	A5413	Pump 1 operating run hours	0 to 999	Hrs	
AO	5414	A5414	Pump 1 operating run khours	0 to 32000	Hrs x1000	
AO	5415	A5415	Pump 2 operating run hours	0 to 999	Hrs	
AO	5416	A5416	Pump 2 operating run khours	0 to 32000	Hrs x1000	
AO	5417	A5417	Pump 3 operating run hours	0 to 999	Hrs	
AO	5418	A5418	Pump 3 operating run khours	0 to 32000	Hrs x1000	
AO	5419	A5419	Pump 4 operating run hours	0 to 999	Hrs	
AO	5420	A5420	Pump 4 operating run khours	0 to 32000	Hrs x1000	
AO	5421	A5421	Reserved			
AO	5422	A5422	Reserved			
AO	5423	A5423	Reserved			
AO	5424	A5424	Reserved			
AO	5425	A5425	Reserved			
AO	5426	A5426	Reserved			
AO	5427	A5427	Reserved			
AO	5428	A5428	Reserved			
AO	5429	A5429	Reserved			
AO	5430	A5430	Reserved			
AO	5431	A5431	Reserved			
AO	5432	A5432	Reserved			
AO	5433	A5433	Number of pump running	0 to 4		
AO	5434	A5434	Lead pump ID	0 to 4		

## 5.4 BAS DATA POINTS - LONWORKS

### PARALLEL SENSORLESS - BUILDING AUTOMATION SYSTEM REV 13031

LonWorks Communication Interface - FTT-10

NO	TYPE	NAME NV	TYPE NV	DIRECTION	RES/UNIT	UNITS
1	ANL	nvoTotalDrvKW	28	Output	0.1 kW	
2	ANL	nvoNumOfRun	8	Output	1	
3	ANL	nvoLeadPump	8	Output	1	gpm, lps, m <sup>3</sup> /hr
4	ANL	nvoDrv1Amp	1	Output	0.1 Amp	
5	ANL	nvoDrv1Kw	28	Output	0.1 kW	
6	ANL	nvoDrv2Amp	1	Output	0.1 Amp	
7	ANL	nvoDrv2Kw	28	Output	0.1 kW	
8	ANL	nvoDrv3Amp	1	Output	0.1 Amp	
9	ANL	nvoDrv3Kw	28	Output	0.1 kW	
10	ANL	nvoDrv4Amp	1	Output	0.1 Amp	
11	ANL	nvoDrv4Kw	28	Output	0.1 kW	
12	ANL	nvop1Speed	34	Output	0.1%	
13	ANL	nvop2Speed	34	Output	0.1%	
14	ANL	nvop3Speed	34	Output	0.1%	
15	ANL	nvop4Speed	34	Output	0.1%	
16	ANL	nvoWord1	83	Output	1 bit	
17	ANL	nvoWord2	83	Output	1 bit	
18	ANL	nvoWord3	83	Output	1 bit	
19	ANL	nvoWord4	83	Output	1 bit	
20	ANL	nvoWord5	83	Output	1 bit	
21	ANL	nvoWWEff	8	Output	1 bit	
22	ANL	nviHeadDes	30	Input	0.1 Unit	
23	ANL	nviZeroFlowHead	30	Input	0.1 Unit	
24	ANL	nviHeadBEP	30	Input	0.1 Unit	
25	ANL	nviFlowBEP	15	Input	0.1 Unit	
26	ANL	nviStageDeadBand	8	Input	0.1 Unit	
27	INT	nviStageFactor	8	Input	1	
28	INT	nvoSystemHead	15	Output	1 Unit	
29	INT	nvoSysFlow	8	Output	1	
30	INT	nvoLeadPump	8	Output	1	
31	INT	nviDesFlow	8	Input	1	
32	INT	nviNoOfPumps	8	Input	1	
33	INT	nviPmpSwitchTime	8	Input	1	
34	DGT	nviRemStart	95	Input	On/Off	
35	DGT	nviAlarmReset	95	Input	On/Off	



	NAME NV
nvoWord5 Bit:	Reserved
	Reserved
	Spare
	Spare
	Spare
	Spare
	Spare
	Spare
	Spare
	Spare
	Spare
	Spare
	Spare
	Spare
	Spare

**TORONTO**

+1 416 755 2291

**BUFFALO**

+1 716 693 8813

**BIRMINGHAM**

+44 (0) 8444 145 145

**MANCHESTER**

+44 (0) 8444 145 145

**BANGALORE**

+91 (0) 80 4906 3555

**SHANGHAI**

+86 21 3756 6696