

Evolution of Pumping Technology and Superior Performance

White paper

File No: 100.253
Date: DECEMBER 15, 2017
Supersedes: NEW
Date: NEW

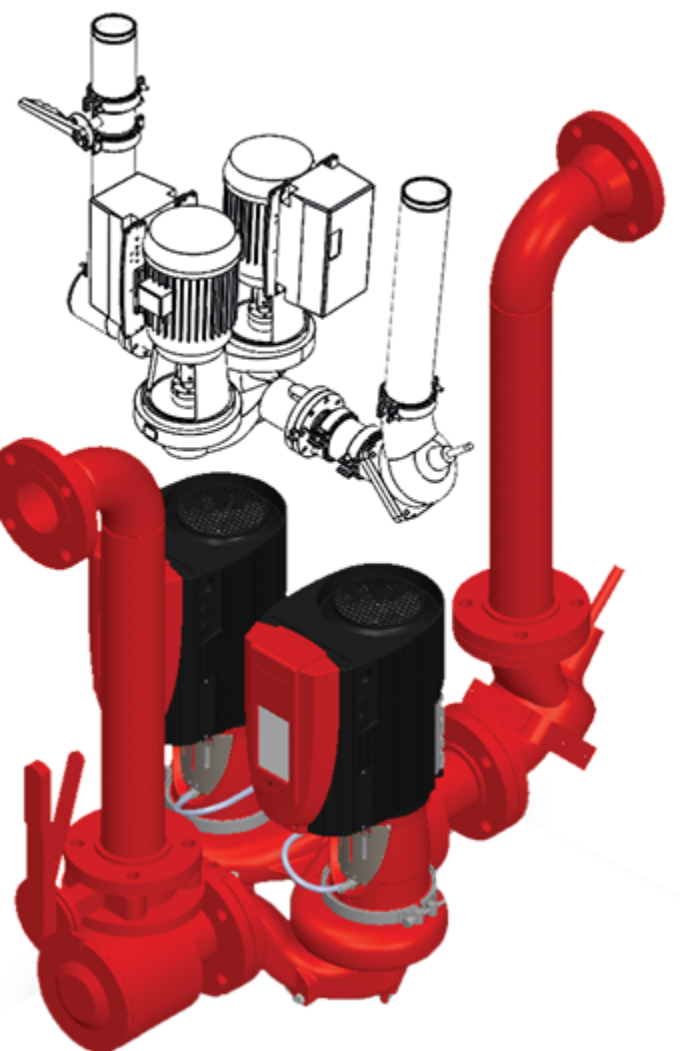

—

—

—

—

HVAC Energy Savings are available now. How does your system compare?

EXECUTIVE SUMMARY

This document begins with a history of the development of variable speed technology, explaining the efficiency improvements associated with each development step. Also presented is an exclamation of the value and importance of best efficiency staging of pumps, followed by a description and explanation of the value of partial redundancy as a more cost-effective and efficient alternative to the traditional duty/standby configuration for pumps.

It's hardly surprising that HVAC system designs have evolved in the last 65 years. The surprising aspect is the number of new and recent installations that rely on old, outdated designs. Look back through your most recent projects. The pumps and related components might be new, but the design might be behind the times.

Here's a look at the recent history of developments in HVAC pumping configurations.

Circa - 1950s through 1990s: Constant speed pumping - 3-way valves

In the **good old days** energy costs did not warrant expensive variable speed controls. Variable speed controls were available for HVAC equipment - typically, belt-drives and fluid couplings - but this was rare. Electronic drives were expensive and unreliable and required special motors.



A typical HVAC system used 3-way valves installed at coils to divert unnecessary flow past the load via bypass piping, so the pumps operated at full speed, with little variation in flow. This resulted in system fluid returning to the boiler/chiller at temperatures closer than ideal to outlet temperature, causing inefficient operation.

In most installations, HVAC pumps were oversized for system needs (an unfortunate habit that has been carried forward to present-day HVAC designs) requiring the system flow to be mechanically throttled, to control the system flow through increased resistance.

Some designers experimented with superior controls, but many of these controls were either incorrectly installed or disabled by site personnel, leading to performance issues like those seen in constant speed applications.

Circa - 1990s to today: Converting constant speed throttled pumps to desired flow and speed

In this time span, variable speed controllers, such as VFDs, make an appearance on walls, as close as feasible to the constant speed pump. Locating the VFD close to the pump was important as VFDs of the day were not kind to motor insulation.



A VFD enables the system throttling valve to be fully opened, and pump speed reduced to deliver the original system design flow requirement; resulting energy savings compared to constant speed systems.

All constant flow/constant speed applications will save energy with the introduction of variable speed controllers. This simple measure typically results in ~15% to 20% energy savings from the throttled system.

Variable Speed Saves Energy in Constant Flow Systems

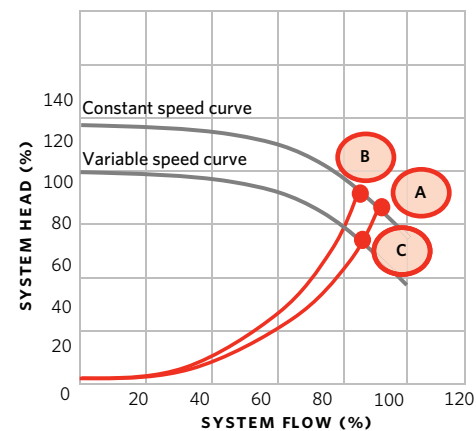

Based on 6" (150mm) 40 hp (30kW) pumping unit

		hp(kW)	Energy Savings	
A	Constant Speed - Unthrottled	31.38 (23.40)	Incremental	Cumulative
B	Constant Speed- Throttled	30.44 (22.70)	3%	3%
C	Variable Speed - Unthrottled Constant Flow	26.50 (19.77)	13%	13%

Significant energy savings are available by installing variable speed pumping units in constant flow systems and removing the **balancing throttling***

Circa - 1990s to today: Variable speed pumping in a 2-way valve variable flow system - Wall mounted VFD with local sensor*

Although there are some exceptions, as a general trend, energy costs have been increasing in recent years, which has forced building operators to examine operating costs more closely. From 1995 to 2005, VFDs began appearing more often on mechanical room walls. Designers of variable flow systems begin to include a system pressure feedback sensor in the mechanical room to save energy on mild days, by limiting system pressure to the pump design head pressure.

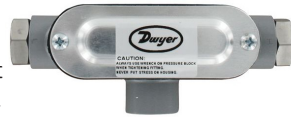

This set-up does not, generally, meet ASHRAE 90.1 requirement of 70% motor power reduction at 50% system load; though it will produce up to 50%, or more, in energy savings, from the throttled system.

*See advantages of Design Envelope pumping units over wall mounted VFD with local sensor, in **APPENDIX 1** of this document.

Circa - 1990s to today: Variable speed pumping in a 2-way valve variable flow system - Wall mounted VFD with remote sensor

While variable speed controls were becoming more popular, motors were also increasing in efficiency and insulation quality, though the majority of installations still use induction motors. The efficiency of induction motors tends to drop off at ~50% average HVAC system load. Unfortunately, pumps are still commonly selected as constant speed, sized for the specified flows and heads only. With feedback sensors placed closer to the most remote load coil, these systems are at least able to meet minimum motor power saving requirements. ASHRAE 90.1, for example, dictates that motors must consume no more than 30% of the design condition energy at 50% load.

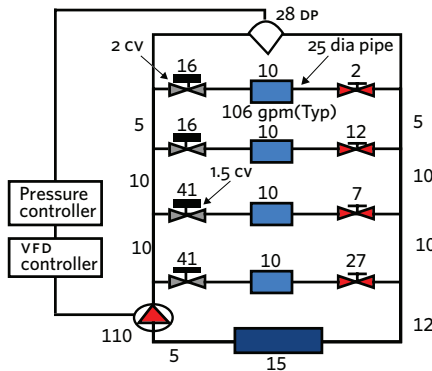

In these types of systems, sensors are usually set to maintain the balanced system pressure at the sensor location, and can produce up to 65%, or more, energy savings, compared to a throttled system.

Circa - 2000s: Design Envelope 3.1 and Sensorless Control Technology

Pump quadratic flow-loss speed control and demand based intelligence [Sensorless Control] is key to uncovering more significant energy savings. In these types of installations, the accuracy of pump speed modulation is supported by detailed performance mapping of every pump. The performance data is embedded into the control algorithms for peak performance in the installation.



Smaller motor sizes can be used in roughly 25% of installations, as load-limiting controls enable motors to be selected tightly. A smaller motor requires a greater percentage of its load at ~50% system load, than larger motors. This means reduced electrical losses, producing relatively higher motor efficiencies. Integrated controllers also lower motor losses, increasing motor efficiencies even more.

Actual pump flow values, with an accuracy of ±5% at BEP flow, are available visually at the equipment and digitally via a BMS. Pump selections can now be optimized for average load against a system load profile. All this enables up to 70%, or more, energy savings, compared to a throttled system.

Circa - 2000s: Design Envelope Generation 3.1 and Generation 5 (to 10hp/7.5kW)

This technology uses advanced digital controls, tuned to the specific motor. The use of iECM motors, with IE5 efficiency ratings boosts energy efficiency substantially. Increased motor efficiency, combined with advanced hydraulics makes the individual pump more efficient than ever. Advanced capabilities for digital control and load sharing among multiple parallel units, with single pipe connections, combine for up to 80%, or greater, energy savings compared to a throttled system.



Circa – Now And Tomorrow: Next Level Thinking

Some of the items being discussed are already commercially available or in the development funnel:

- Parallel multiple pump selections for lower first cost and life cycle cost
- Converting standby pumps into all duty parallel pumps, with appropriate system redundancy should 1-unit fail
- Best efficiency staging control for multiple pumping units
- Improved onboard diagnostics and trending
- Extended warranties with a real-time performance management option
- Valuable application specific performance options such as Auto-flow balancing, Maximum and minimum flow control, Chiller bypass valve control, 2-zone sensor control, Dual season set-up

While the technology has advanced significantly, and will undoubtedly continue to improve as the industry moves to serve the pressing needs for energy efficiency and cost reductions, it may not be sufficient to consider new options for new build projects only. Perhaps the more pressing challenge for building owners, managers and designers is to review recent projects with a critical eye. In many instances, the value network that includes manufacturers, contractors, trades, designers, developers and owners, chooses to reduce installed cost, without properly considering long-term operating costs. The challenge then is this: look critically at your most recent projects. The final installed combination of system design attributes and component selections are a testament to your vision and foresight. Are they outdated?

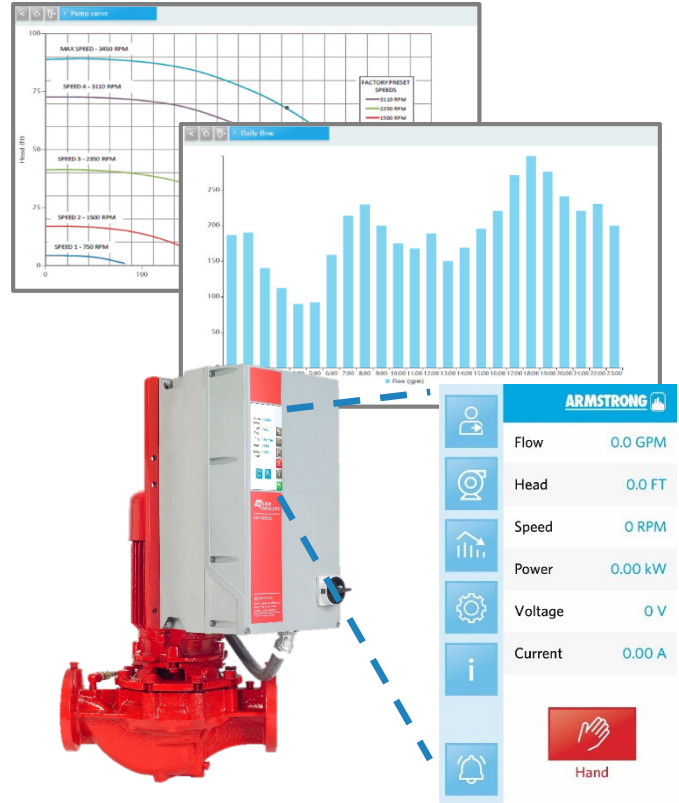

Pump User Interface Screens

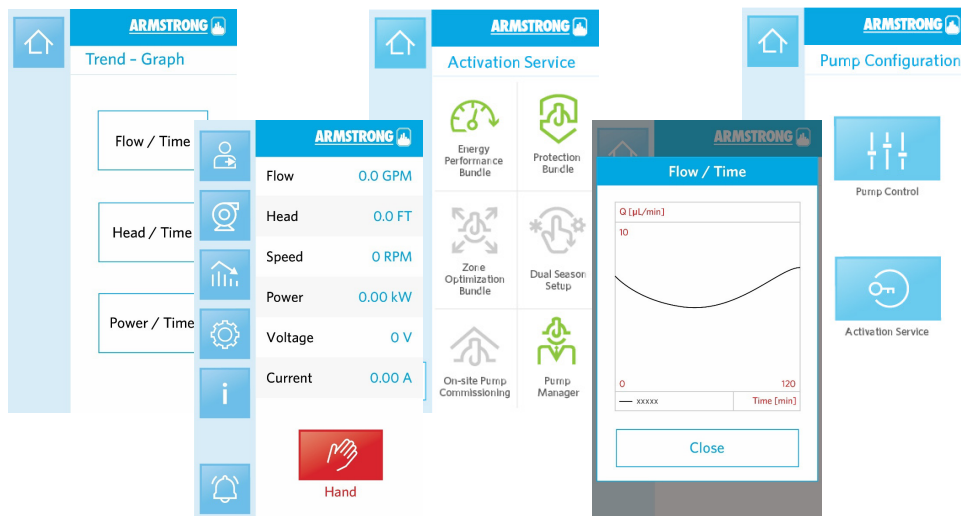

PARALLEL SYSTEMS & REDUNDANCY

Review of Definitions:

- 1 **Parallel Systems:** In this context, all parallel system units are duty units
- 2 **N:** A term for the quantity of duty pieces of equipment required to supply the design flow in a hydronic system
- 3 **N-1:** A term for a parallel system condition, where one of the N quantity pieces of equipment fails to operate
- 4 **Redundancy:** The percentage of the system design flow available to the system in an N-1 condition
- 5 **Capacity Split %:** Percentage of system design flow per pump in a parallel system
 - a **Example:** If design flow = 100 USgpm, then in a 2-pump system:
 - 2*50% capacity split = 50 USgpm/pump
 - 2*70% capacity split = 70 USgpm/pump
 - 2*100% capacity split = 100 USgpm/pump
 - 1 2*100% capacity split is, hydraulically, like a duty/standby specification; however, in parallel operation, the **standby** unit will be activated to operate in parallel with the first unit, if it improves the system efficient
 - 2 HVAC systems are part-load and, generally, oversized, so design day load is rarely, if ever, required
 - 3 2*50% units typically provide ~80% of design flow on a unit failure, which would produce ~95% load coil heat transfer and is recommended for most simple applications!

PARALLEL SENSORLESS REDUNDANCY SELECTIONS (Patent pending Parallel Sensorless is standard)

Objectives:

- 1 Convert **Standby** units into more effective parallel equipment; designed to reduce equipment installed cost, energy consumption, life cycle costs (LCC) and increase control.
- 2 Convert decision makers to specify lean parallel pumping systems. Perhaps 2*50% units in a single pipe (Armstrong Tangos and dualArm) with 80% minimum flow redundancy for 95% heat transfer
- 3 2*60%, 70%, 80% & 90% are also available, depending on desired redundancy level and optimum customer value
- 4 Multiple quantities of pumps are examined to ensure optimum customer value
- 5 For full redundancy applications (hospitals, data centers, etc) then 2*100% units may be selected (Armstrong Tangos or

dualArm for full effectiveness) which benefit from parallel pump staging control operation

- 6 Lowest Installed Cost, Life Cycle Costs and Carbon Footprint
- 7 Parallel Pump Staging - Best efficiency staging, for lowest operating costs, as standard, versus typical load / speed based staging

Parallel Pump Staging - Best efficiency staging as standard

Best efficiency staging as versus typical load/speed based staging

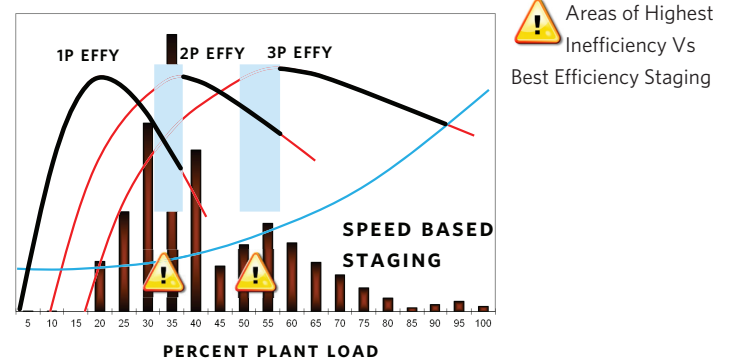
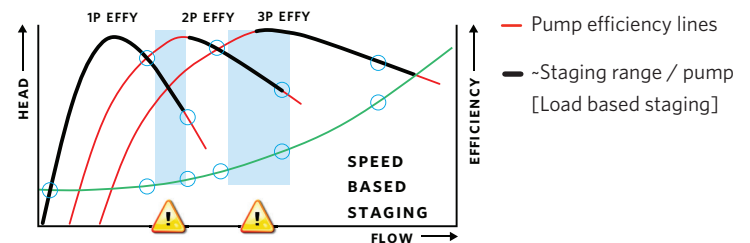
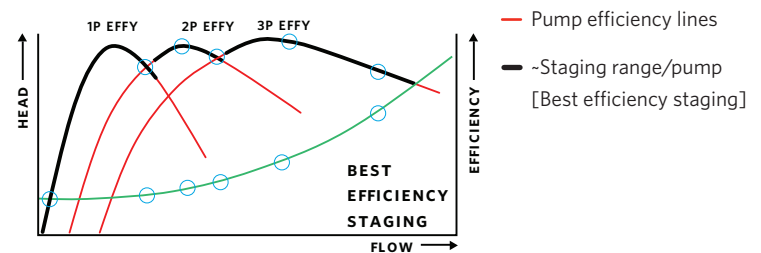

Overlaying load based staging data onto a load profile
Load based staging can miss best efficiency at highest demand

ALTERNATIVE PRODUCT SOLUTIONS

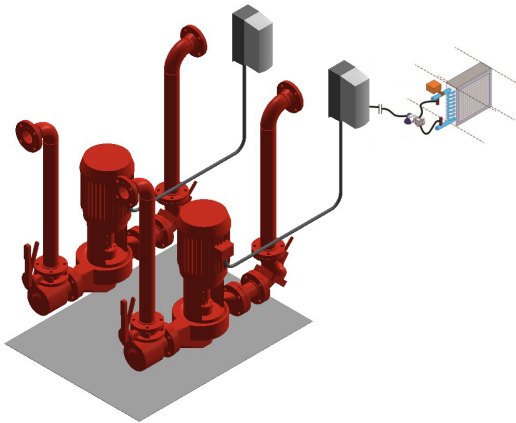

Traditional D/S VIL



Design Envelope VIL in Parallel

- Reduced installed power
- Integrated controls
- Sensorless technology
- High level of redundancy
- Low space requirement

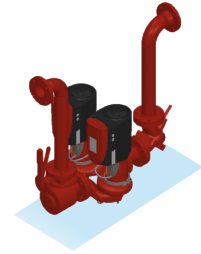

Design Envelope Tango with Parallel Operation

- Reduced installed power
- Super efficient Intelligent EC Motor
- Sensorless technology
- High level of redundancy
- Lowest space requirement
- Lowest carbon footprint

COST/CARBON FOOTPRINT – SIZING FOR 100% STANDBY VS 2 × 50% IN PARALLEL

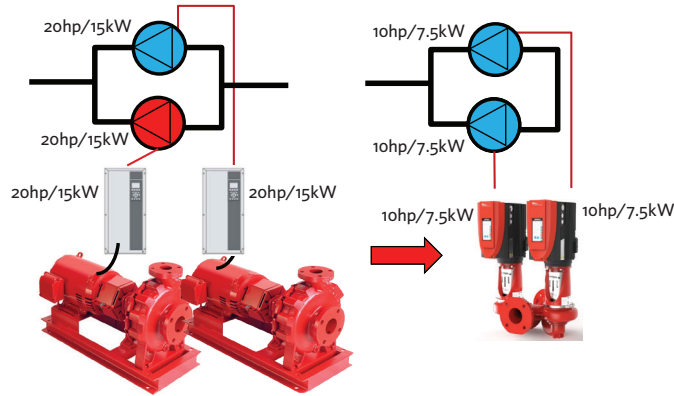

Duty/Standby units are selected for the best design full flow efficiency. At average HVAC system needs (~50% full load) pump and motor efficiency is much lower. Smaller pumps and motor, designed for part-load conditions offer the 1st installed cost and Life Cycle Cost leaving a low carbon footprint.

DUTY/STANDBY VS TANGO COMPARISON

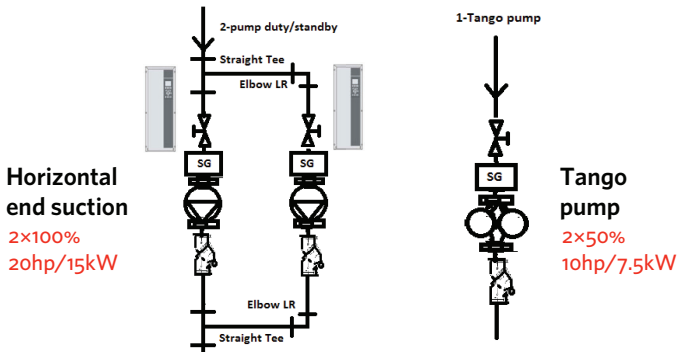

	2 PUMP DUTY/STANDBY	1 TANGO PUMP	TANGO SAVINGS
Total Pump Weight	1232 lbs/559 kg	192 lbs/87 kg	84%
Installation weight	2802 lbs/1,271 kg	714 lbs/324 kg	75%
Installation footprint	28 sq-f/2.57 sq-m	5 sq-f/0.46 sq-m	82%
Installation cost (less pump)	\$7,400	\$2,550	65%

Using single supply and discharge piping decreases energy costs by ~5%, plus no added piping, tees or elbows are required

See Saving Energy by Piping Configuration white paper File No: 100.251 for more detail

PARALLEL REDUNDANCY SELECTION (PRS)

TURNDOWN – See ASHRAE 90.1-2016 Sect 6

- Percentage of design flow that can be accurately measured
- Armstrong Design Envelope units are accurate to ±5% of BEP flow, at nominal speed, with resulting values applicable from 30% to 110% of the BEP flow
- More pumps means higher turndown ratios (5% flow = 20:1 turndown)

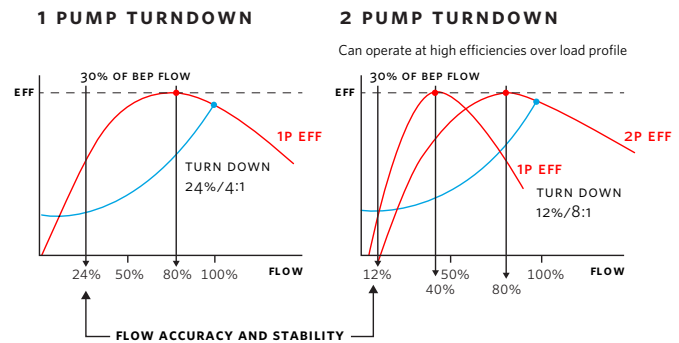

More about Redundancy

One Redundancy definition: ... “the inclusion of extra components that are not strictly necessary to functioning, in case of failure in other components”

This sounds suspiciously like a standby pump, right? For this discussion, redundancy is about knowing 3 important items:

- 1 Centrifugal pumps, working in parallel operation will, each, pump more fluid when one unit fails in operation.

This phenomenon is known as **run-out** and is caused by system pressure falling, as one of the operating units fails. Then all other units online, will run-out on their own performance curve, pumping more flow and combining all the flows as they each balance the system pressure.

- 2 On a design day, when all heating or cooling load is required, the resulting total system flow from item 1 will, rarely, be equivalent to the design flow. The flows will find equilibrium with the system pressure curve and end up somewhat short of the full design flow. The Armstrong solution for this is:

- a Don't pay for more than you need. Understand the building and system needs in the event of a pump loss and select the units to match the need
- b Armstrong Design Envelope best efficiency parallel pump control will automatically increase the speed of all remaining pump to the maximum speed or motor capability. This will increase the volume of water available to the system

- c At pump selection, Armstrong software will estimate the one-unit failure system flow and display the flow rate at pump selection and on submittal data. On site, the actual flow is read by the integrated controls and made available at the unit(s) or electronically to the building system
- 3 Because of safety factors in HVAC system design estimates, system requirements are notoriously oversized; meaning that system balancing personnel typically throttle (Hopefully, only in the past) or reduce equipment speed by 15% to 20% to produce the system design flow. This, combined with HVAC systems being part-load, where an average load may be 50% of design flow, means that chances of not meeting the actual system load requirement is slim, or none.

Redundancy for random parallel pump quantities and percentages of design flow are displayed in table below. These values are estimated only; though all Armstrong pump selections will detail the values at selection and on the submittals

QUANTITY OF MOTORS - PERCENTAGE OF DESIGN FLOW EACH	EXPECTED REDUNDANCY RANGE	EXPECTED COIL HEAT EMISSION	
		COOLING	HEATING
1 - 100%	0%	0%	0%
2 - 50%	75% - 80%+	95%	90%
2 - 70%	85% - 90%+	95% - 100%	
3 - 33.3%	85% - 90%+	95% - 100%	
6 - 16.7%	90% - 95%+	95% - 100%	
2 - 100%	100%	100%	

Building tenants will hardly notice any change is HVAC comfort

REDUNDANCY (2-PUMP SYSTEM)

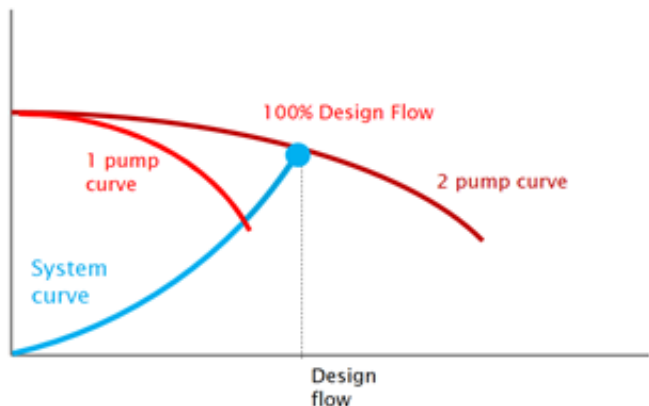

Illustration of 2-pump parallel operation, detailing 1-pump curve + 2-pump combined curve to deliver the full design flow and head. The system curve illustrates the system head at zero to 100% flow

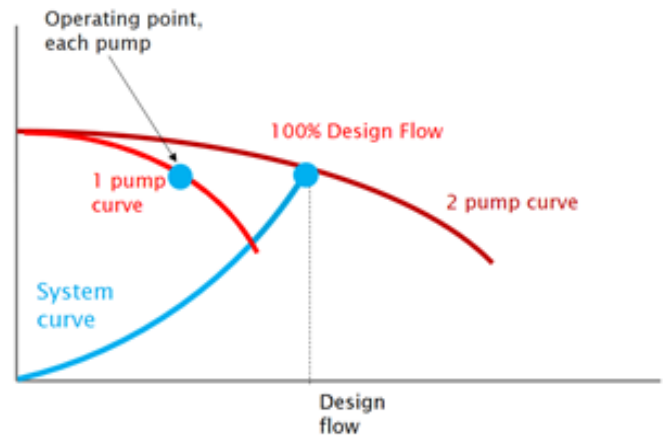
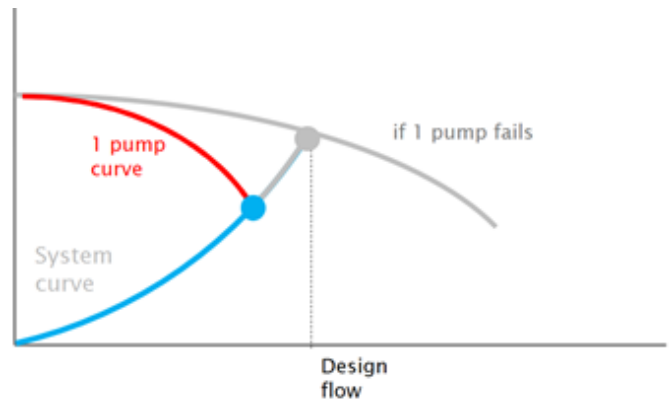
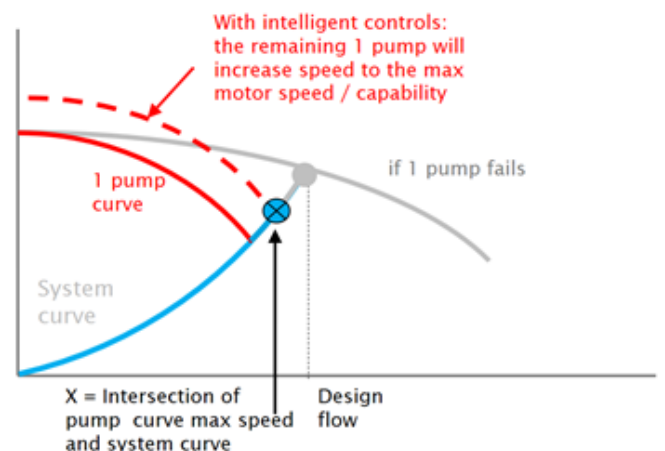

Illustration of operating point for each of the 2-pumps that make up the 2-pump curve



Should 1 pump be deactivated during a design day (full flow and head required to service the system) the remaining pump would move out on the pump curve until it intersect the system curve. That intersection typically illustrates the maximum flow available to the system, until the failed unit is reactivate



With Design Envelope units, intelligent pump controls act when 1-pump fails, to increase the speed of the remaining pump(s) to maximum speed or motor capability. This provides the maximum flow available to the system. This state is termed N-1 (Number of duty pumps [N], less the failed unit [-1]) and the maximum flow available at N-1, when expressed as a percentage of design flow is termed redundancy

$$\text{Redundancy (\%)} = \frac{\text{flow rate at X}}{100\% \text{ design flow}}$$

REDUNDANCY IMPLICATIONS IMPACT ON COOLING OR HEATING OUTPUT

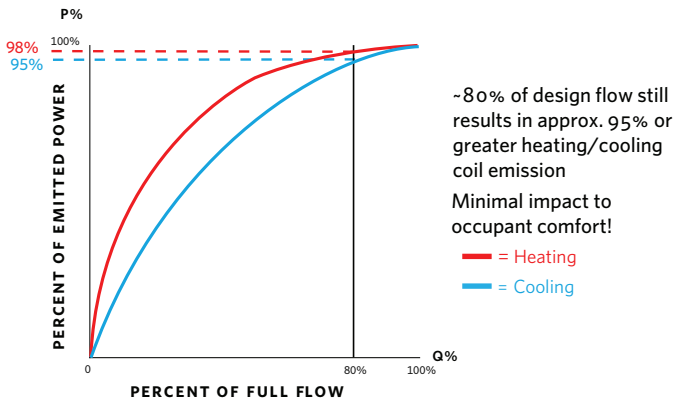

Redundancy results are, typically, less than 100% of the design flow; however, this may not have a negative impact the conditioned space of the building occupants. Rather than supplying [2] large duty/standby units a user may install 2*50% flow units, producing a redundancy of 80% in N-1 operation. In a normal HVAC heating & cooling coils, 80% of design system flow would produce ~95% heat emission, so that the system’s temporary flow loss would rarely affect the conditioned tenant spaces

REDUNDANCY LEVEL (MIN)	BUILDING TYPE
Generic (Duty Only) ≥ 70%	School, Apt / Condo,
	Religious Inst, Factory / Warehouse,
	Multi-Sensored zones
Highly Comfort Sensitive Sectors ≥ 85%	University, Campus,
	Commercial, Hotel, Office,
	Mixed use, Outpatients
Mission Critical ≥ 100%	Data Center, Critical Care,
	Critical Care, Blood Banks,
	Labs / R&D, Hospital

Project redundancy can be selected in an equipment selection. As Armstrong defaults: Buildings that typically supply pumps without backup, would select pumps with a minimum of 70% redundancy. This will be a huge lift for building comfort security in inclement weather. Non-critical buildings, though sensitive to comfort, would be given an 85% minimum redundancy, so that building occupants will not notice a pump failure. Mission critical selections will ensure 100% redundancy; though would accomplish this by, typically, using oversize all-duty parallel units that still ensure best efficiency pump staging.

Pump failures are very rare and, typically, spend many years without needing service. Items like the Pump Manager, a Design Envelope intelligent controls option, will warn building operators of pending service needs, which should eliminate pump failure at high-peak time

DESIGN ENVELOPE PARALLEL SAVINGS BEYOND DUTY/STANDBY SPECS

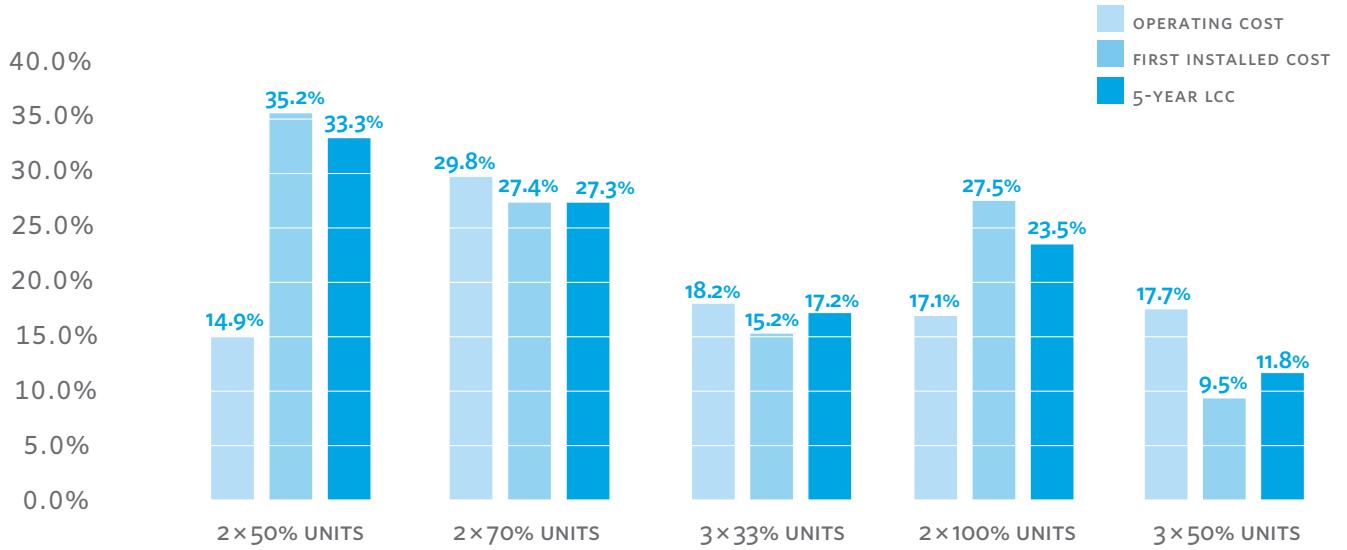

Redundancy level (min)	General use ≥ 70%	Highly comfort-sensitive sectors ≥ 85%	Mission critical ≥ 100%
Sample Buildings	School, apt/condo, factory/warehouse	University, campus, commercial hotel, office, mixed-use, outpatients	Data center, critical care, blood bank, labs/R&D, hospital
<750 Usgpm (<47 lps)	Tango/dualArm 2 x 50%	Tango/dualArm 2 x 70%	Tango/dualArm 2 x 100%
750 - 2000 Usgpm (47 - 126 lps)	Tango/dualArm 2 x 50%	dualArm/ Design Envelope VIL 2 x 70%	dualArm/ Design Envelope VIL 2 x 100%
2000 - 5000 Usgpm (126 - 315 lps)	dualArm/ Design Envelope VIL 2 x 50%	Design Envelope VIL 3 x 33%	Design Envelope VIL 3 x 50%

Comparing customer values, such as operating cost, 1st installed cost and [5-yr] LCC (Life Cycle Cost) from selections for varying system flows and redundancy levels: Significant savings versus duty/standby costs are obvious at all levels.

APPENDIX 1

Design Envelope pump or a vFD mounted on a wall with a separate pressure feedback sensor?

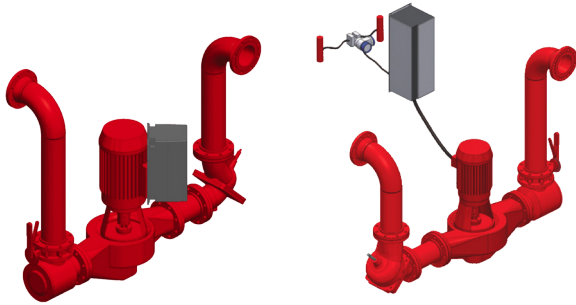

FIG.1 Armstrong Design Envelope pump

FIG.2 Traditional pump with vFD mounted on a wall and supplied with a separate pressure feedback sensor for pipe mounting

The Armstrong Design Envelope pump is a unique solution, available with integrated controls up to 450hp/355kW.

Configuring a pumping solution to use integrated controls has many advantages over a traditional pump controlled by a vFD mounted on a wall, with a separate pressure feedback sensor for pipe mounting. These advantages include:

Design Envelope advantages

- 1 Selections save energy and cost
- 2 Impeller trim saves energy and cost
- 3 Superior control
- 4 Smaller size motor and control
- 5 Wiring to vFD & vFD mounting bracket savings
- 6 Harmonic distortion reduction
- 7 Emission and immunity requirements
- 8 Reflected wave voltage eliminated
- 9 Envelope selection reduces risk and cost
- 10 Energy metering capability
- 11 Finding wall or floor space not necessary

AN INTEGRATED APPROACH TO REDUCING SYSTEM COST

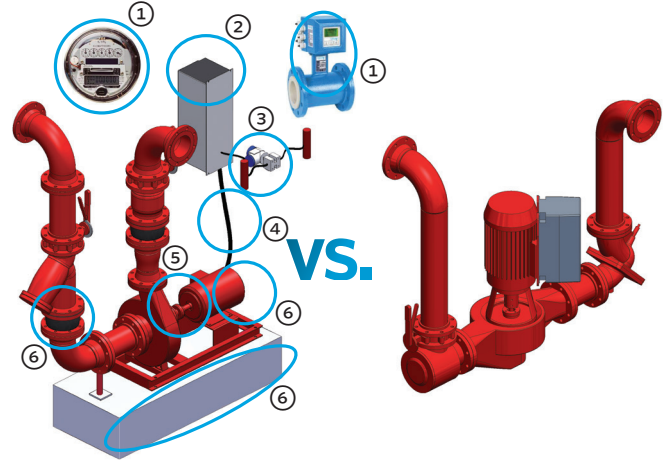

- ① Energy and Flow Metering
- ② Harmonic and RFI Filtering
Thermistors and Space Heaters
- ③ Sensor Acquisition and Installation
- ④ vFD Mounting and Wiring
- ⑤ Coupling Re-alignment
- ⑥ Concrete base, Grouting, Flex Connectors

DESIGN ENVELOPE PUMP SELECTIONS SAVE ENERGY AND COST

Design Envelope pumps are selected to minimize energy costs over a typical HVAC load profile. This generally results in pump selections with the design point located to the right of the best efficiency point (BEP) so that during part-load (where the pump operates most the time), the pump operates at higher efficiencies by being closer to the best efficiency region for the pump. A traditional pump selection ignores energy costs over the HVAC load profile and often does not meet the modern requirements of building codes such as ASHRAE 90.1.

TRADITIONAL PUMP WITH DESIGN POINT TO LEFT OF BEP

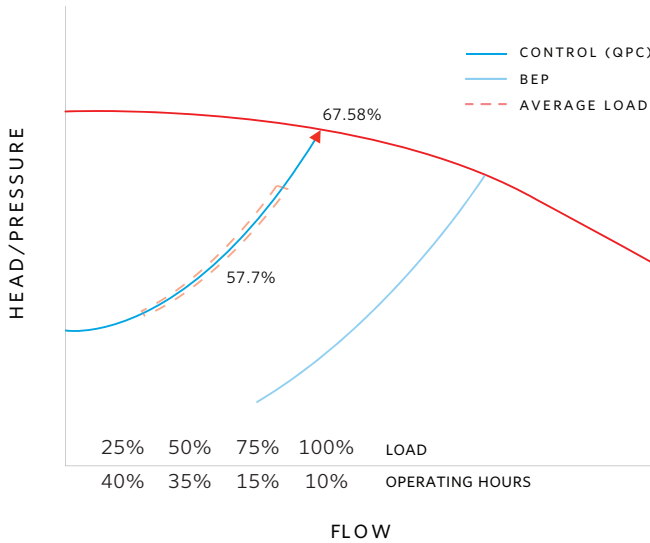

DESIGN ENVELOPE IVS PUMP WITH DESIGN POINT TO THE RIGHT OF BEP

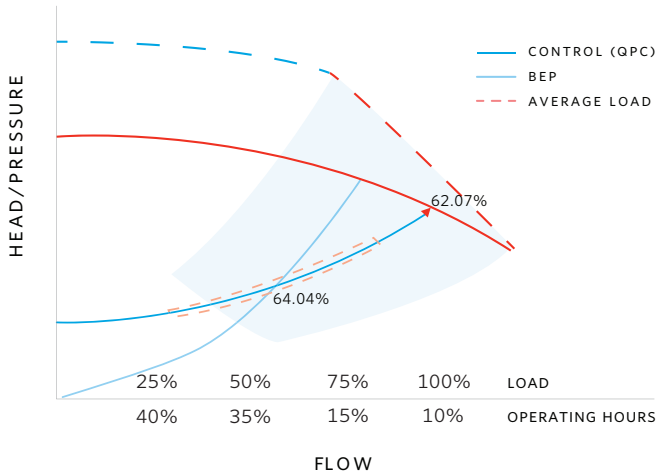

A Design Envelope selection is often smaller and in a typical example saved 7% in pump cost and 9% in energy costs.

DESIGN ENVELOPE IMPELLER TRIM SAVES ENERGY AND COST

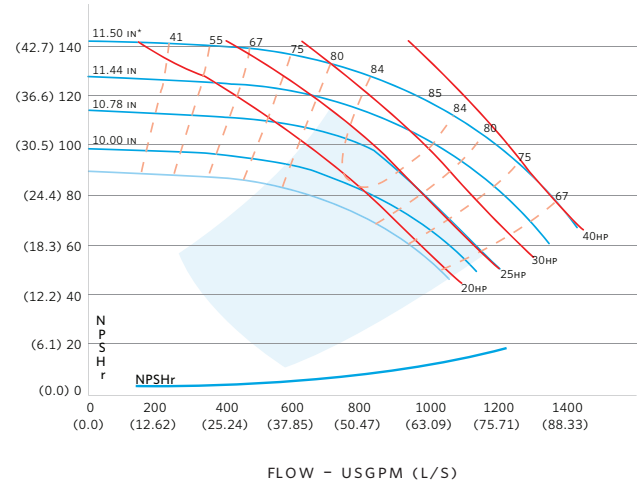

Design Envelope pumps are designed with impellers trimmed to optimize efficiency and capacity by using the load limiting ability of the controls. Where a traditional pump impeller is trimmed to the customer's design point, with the motor 'non-overloading' for the whole curve, the impeller in a Design Envelope selection is generally trimmed close to the pump best efficiency point [BEP] for a power draw matching the motor size, which cannot overload over the operating range of the unit. This offers two key benefits:

- This increases the capacity of the pump by up to 10% such that a smaller pump can be selected.
- By using a larger impeller trim and reducing speed to meet the customer's design point, **the Design Envelope pump can be over 5% more efficient.**

SUPERIOR CONTROL

For duty/standby applications in which, by design, one pump is always stopped, Sensorless control is available. Sensorless control enables a pump to decrease or increase speed to match system requirements without any external signal. Customer values include:

- Parallel Sensorless Control saves pump and energy costs by allowing 2-smaller pumps to replace duty/standby and stage at best efficiency for the system
- Energy savings equivalent to placement of a sensor across the most remote heat exchanger, typically saving ~50% more energy than a sensor in the mechanical room
- **Cost savings of \$2000 in installation, wiring, and sensor costs**

- Easy adjustment and trouble-shooting at the pump, as opposed to at the remote sensor in the building. Simplified commissioning alone is estimated to save \$600 average, per pump

The pump flow and head is available visually on the control keypad read out and digitally for the building communication protocol. When properly selected the flow readout accuracy will be ±5%. Many customers appreciate how this flow readout can eliminate the need for an expensive flow meter.

Pump specific control functions and menus – generic variable frequency drives are used in many different applications including pumps, fans, material handling, lifts etc. Design Envelope pumps use integrated controls specifically for pumping applications. The integrated controls can display real-time load and even differential pressure settings when available from the customer pre-set to the site requirement. Menu interfaces and instructions are factory programmed for the pumping units which result in quicker, easier commissioning and energy efficient operation.

SMALLER SIZE MOTOR AND CONTROLS

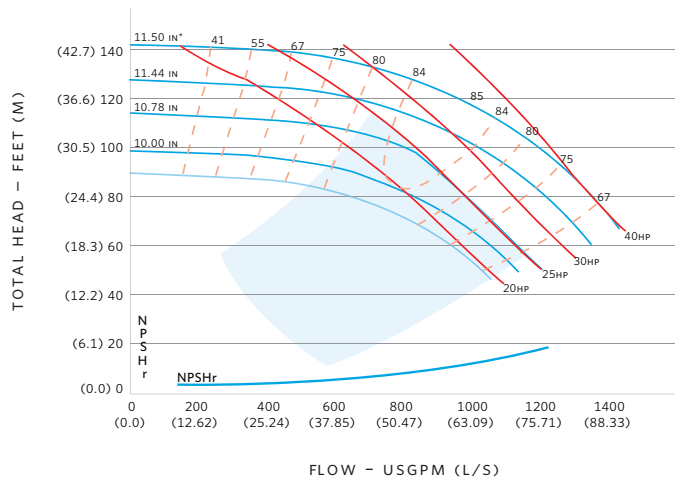

Traditional pumps are selected for non-overloading power to the end of curve, which often results in using larger motor and controls than necessary for the design point. Furthermore, if a bypass is installed on the drive then the motor must be oversized for situations in which the bypass is activated and the motor is operating at full speed. Design Envelope pumps are selected such that they maximize the motor’s full capability while the controls use electronic load limiting logic to prevent overloading. This typically results in a smaller size motor and control. In the example below, a duty point of 900gpm at 90 ft results in a 25hp/20kW versus a 30hp/25kW motor selection. The cost savings between a 25hp/18.5kW and a 30hp/22kW motor and drive is 9%.

WIRING AND VFD MOUNTING BRACKET SAVINGS FROM THE DRIVE ON THE WALL TO THE PUMP



POTENTIAL WIRING SAVINGS

Wiring and vfd mounting bracket savings from the drive on the wall to the pump – As the control is integrated with the pumping unit there is no power wiring required from the drive mounted on a wall to the pumping unit. For a pump with 40hp motor and controls, the savings are estimated to be \$340 per pump.

HARMONIC DISTORTION

- A** Harmonic distortion is directly proportional to motor size. As described above, motor selections for Design Envelope pumps are generally smaller than selections for fixed speed pumps. Harmonic distortion is reduced by 16.6% between a 25 hp /20 kW versus a 30 hp /25 kW motor.
- B** Design Envelope pump controls include built-in DC line reactors. If a drive on a wall is installed without built in DC line reactors, an external AC line reactor often must be installed. The external AC line reactor requires space and a 10 hp is estimated to cost \$500.

EMISSION AND IMMUNITY REQUIREMENTS

Design Envelope pumps include RFI filters to ensure compliance to low emission and immunity requirements EN61800-3 to the 1st environment class C1 (EN55011 unrestricted sales class B). Wall-mounted drives often do not include these and must be provided as an extra.

REFLECTED WAVE VOLTAGE

If the distance between the motor and the control is long; a standing wave can form between the motor and control. These waves can increase the voltage at the motor terminals causing the motor to fail prematurely. Locating the control near the motor can prevent this problem and shaft grounding devices become redundant.

DESIGN ENVELOPE SELECTION REDUCES RISK AND COST

Pumping selections can change many times during a typical large construction project. After the building is occupied, the load changes many times during the building life due to exterior exposure changes and building use changes. Design Envelope pumps are selected for a large envelope of efficient operation. This envelope typically covers changes during design, construction and operation. Traditional pumps are selected for a specific design point and impellers are trimmed to that point. With fixed speed pumps, load changes usually involve a change in impeller trim and sometimes even motor sizing resulting in engineering time to specify the changes and the cost of equipment changes. On a recent major installation it was estimated that **Design Envelope pumps avoided schedule delays and saved \$25,000 during the construction phase alone due to the ability to accommodate changes to the building load.**

ENERGY METERING CAPABILITY

Design Envelope pumps incorporate the ability to record and cumulate pumping unit energy consumption. Normal wall-mounted drives do not have this ability.

SAVES WALL SPACE

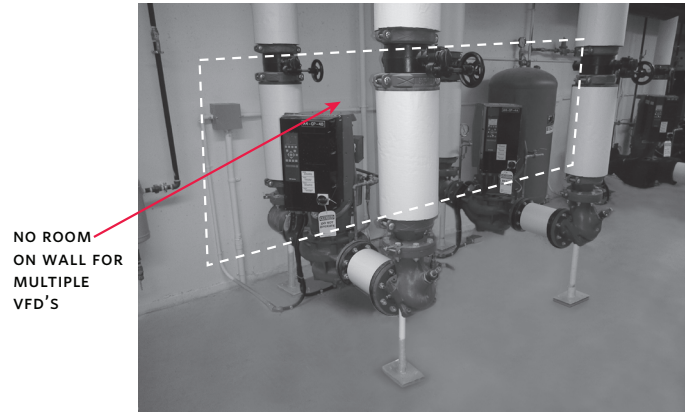

Wall space is as valuable as floor space! Using Design Envelope pumps with integrated controls means valuable wall real estate is not used. Equipment can be positioned closer to the mechanical room perimeter because the walls are kept clear. Also it is often not possible to mount wall drives in the optimum location and wiring costs and reflected wave voltage are increased due to longer distances.

CONCLUSION

The Armstrong Design Envelope Pump offers many advantages over a traditional pump with a wall-mounted VFD. The key advantages are cost savings, reduced harmonics and standing wave voltage, energy savings, reduced design work and improved control.

TORONTO

23 BERTRAND AVENUE
TORONTO, ONTARIO
CANADA
M1L 2P3
+1 416 755 2291

BUFFALO

93 EAST AVENUE
NORTH TONAWANDA, NEW YORK
U.S.A.
14120-6594
+1 716 693 8813

BIRMINGHAM

HEYWOOD WHARF, MUCKLOW HILL
HALESOWEN, WEST MIDLANDS
UNITED KINGDOM
B62 8DJ
+44 (0) 8444 145 145

MANCHESTER

WOLVERTON STREET
MANCHESTER
UNITED KINGDOM
M11 2ET
+44 (0) 8444 145 145

BANGALORE

#59, FIRST FLOOR, 3RD MAIN
MARGOSA ROAD, MALLESWARAM
BANGALORE, INDIA
560 003
+91 (0) 80 4906 3555

SHANGHAI

UNIT 903, 888 NORTH SICHUAN RD.
HONGKOU DISTRICT, SHANGHAI
CHINA
200085
+86 (0) 21 5237 0909

SÃO PAULO

RUA JOSÉ SEMIÃO RODRIGUES AGOSTINHO,
1370 GALPÃO 6
EMBU DAS ARTES
SAO PAULO, BRAZIL
+55 11 4781 5500

ARMSTRONG FLUID TECHNOLOGY
ESTABLISHED 1934

ARMSTRONGFLUIDTECHNOLOGY.COM

MAKING
ENERGY
MAKE
SENSE™