

Vertical Multistage Pumps

VMS 4 B - 2 pole - DIN

SUBMITTAL

JOB: _____	REPRESENTATIVE: _____
_____	_____
ENGINEER: _____	ORDER NO: _____ DATE: _____
CONTRACTOR: _____	SUBMITTED BY: _____ DATE: _____
_____	APPROVED BY: _____ DATE: _____

VM Closed coupled motor Construction type; IM 3619

CONNECTION	MIN. PRESSURE CLASS OPTIONS	MOTOR DIMENSIONS			VMS(S)-/E/V/T		VMS(C/S)F		UNIT WEIGHT
		MODEL	kW	E1	E2	F1	F1	KG	
4/2	PN10	0.37	138	109	420	453	17.6		
4/3		0.55	138	109	441	466	18.1		
4/4		0.55	138	109	463	488	18.5		
4/5		0.75	160	150	528	553	25.2		
4/6		1.1	160	150	550	573	25.6		

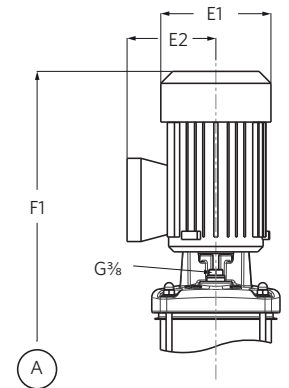

V Long coupled motor Construction type; V18

CONNECTION	MIN. PRESSURE CLASS OPTIONS	MOTOR DIMENSIONS			VMS(S)-/E/V/T		VMS(C/S)F		UNIT WEIGHT
		MODEL	kW	E1	E2	F1	F2	F1	
4/2	PN10	0.37	138	109	472	259	497	284	17.6
4/3		0.55	138	109	493	280	518	305	18.1
4/4		0.55	138	109	515	302	540	327	18.5
4/5		0.75	160	150	590	333	615	358	25.2
4/6		1.1	160	150	612	355	637	380	25.6
4/7		1.1	160	150	633	376	658	401	26.0
4/8		1.5	185	160	661	408	686	433	32.2
4/9		1.5	185	160	682	429	707	454	32.6
4/10		1.5	185	160	704	451	729	476	33.0
4/11		2.2	185	160	754	472	779	497	34.5
4/12	PN16	2.2	185	160	776	494	801	519	35.1
4/14		2.2	185	160	819	537	844	562	36.0
4/16		3	205	175	904	590	929	615	46.6
4/18		3	205	175	947	633	972	658	51.8
4/20	PN25 PN40	3	205	175	990	676	1015	701	52.7
4/22		4	220	190	1042	719	1067	744	60.5
4/24		4	220	190	1085	762	1110	787	61.3
4/26		4	220	190	1128	805	1153	830	77.7

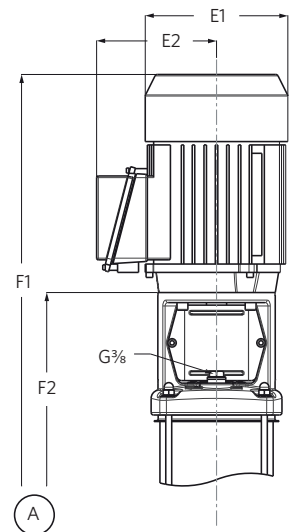

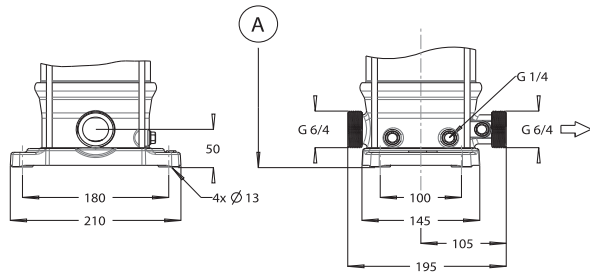

VMS E Male thread -

With non return valve insert at discharge side and pressure measurement plug at upstream side
 Norm: G EN ISO 228
 Size: G 6/4
 Pressure Class: PN16
 Option: Base plate in cast SS 1.4308

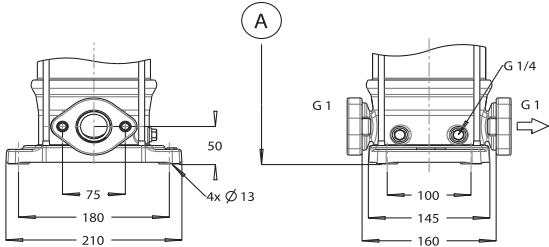

VMS (S)

Counter flange with female thread included
 DPV: Cataphoric coated cast iron
 DPVS: Cast Stainless steel 1.4408
 Norm: G EN ISO 228
 Size: G1
 Pressure Class: PN16
 Option: Base plate & flange in SS 1.4308

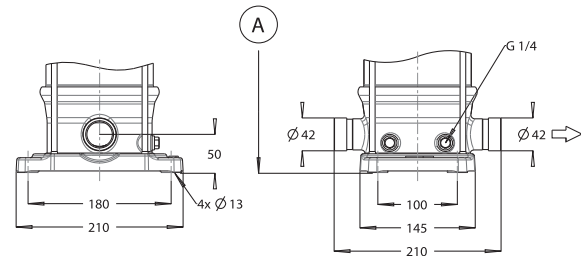

VMS (S) V Victaulic

Norm: -
 Size: 42.2
 Pressure Class: PN25
 Option: Base plate in cast SS 1.4308

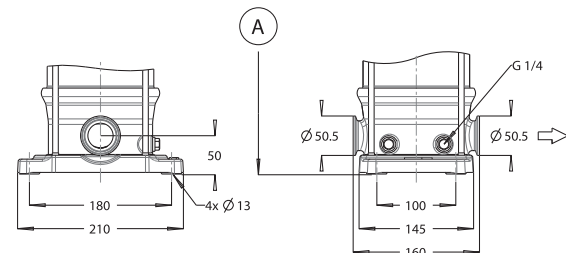

VMS S T Tri-Clamp

Norm: 32676
 Size: DN32
 Pressure Class: PN16
 Option: Base plate in cast SS 1.4308

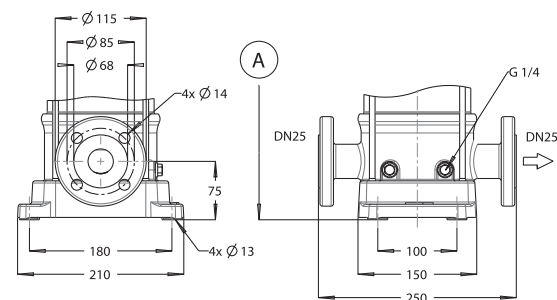

VMS C F Cast Iron Flange

Norm: EN 1092-1/1092-2
 Size: NW25
 Pressure Class: PN40

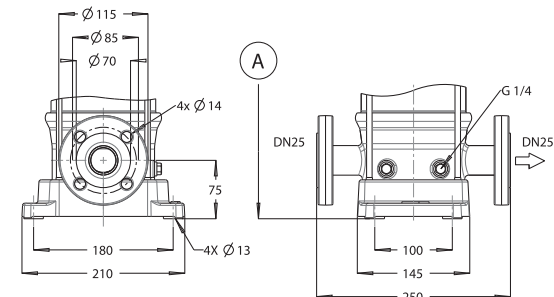

VMS (S) F Round collar flange

Cataphoric coated collar flange
 Norm: EN 1092-1/1092-2
 Size: NW25
 Pressure Class: PN40
 Option: Collar flange and/or base plate in cast SS 1.4308

ARMSTRONG INTEGRATED LIMITED

Wenlock Way
 Manchester
 United Kingdom, M12 5JL
T: +44 (0) 8444 145 145
F: +44 (0) 8444 145 146

S. A. ARMSTRONG LIMITED

23 Bertrand Avenue
 Toronto, Ontario
 Canada, M1L 2P3
T: 416 755 2291
F: 416 759 9101