

# AGE3 CIRCULATOR | SINGLE-HEAD VARIABLE SPEED | 40-120Z | SUBMITTAL

File No: 10.8554IEC  
Date: MAY 10, 2017  
Supersedes: NEW  
Date: NEW

Job: \_\_\_\_\_ Representative: \_\_\_\_\_  
 \_\_\_\_\_ Ordered by: \_\_\_\_\_ Date: \_\_\_\_\_  
 Engineer: \_\_\_\_\_ Submitted by: \_\_\_\_\_ Date: \_\_\_\_\_  
 Contractor: \_\_\_\_\_ Approved by: \_\_\_\_\_ Date: \_\_\_\_\_

## PUMP DETAILS

TAG	MODEL	FLOW	HEAD	SYSTEM	LOCATION

### MOTOR DESIGN DATA

**Motor enclosure:** IP44  
**Power supply:** 230/1/50  
**Insulation class:** F  
**Motor efficiency:**  $EEI \leq 0.21$   
**Inverter/motor type:** ECM/Permanent magnet  
**Motor speed:** Variable speed

### ELECTRICAL DATA

1x230,50HZ, IEC38	P1[W]	I [AMPS]
Auto min.	25	2.6
Auto max.	480	3.8

### ELECTRICAL CONNECTION

**Type:** 3 wires (L,N,Earth)  
**Connector:** 3 pins connector & cable gland

### BMS CONNECTIVITY

**Input /output:** 1 x analogue I/O, 1 x digital I/O and 1 x relay  
**Serial communication:** Modbus RTU and Ethernet

### MATERIALS OF CONSTRUCTION

**Impeller:** PES  
**Casing gasket:** EPDM 70 Shore  
**Bearings:** Grafit  
**Pump casing:** Bronze  
**Shaft:** Stainless steel  
**Can:** Stainless steel

### MECHANICAL CONNECTION

**Type:** Flanged  
**Pressure rating:** PN6/10  
**Size:** DN40

### ENVIRONMENT LIMIT DATA

**Water temp max:** 110°C  
**Water temp min :** 2°C  
**Ambient temp. max:** 40°C  
**Min. pressure:** 0.05 BAR < 75°C,  
 0.28 BAR < 90°C

**DIMENSIONS**

A	B	C	D	E	WEIGHT
mm (inches)					kg (lbs)
260 (10.2)	65 (2.6)	250 (9.8)	75 (3.0)	75 (3.0)	10.2 (22.5)

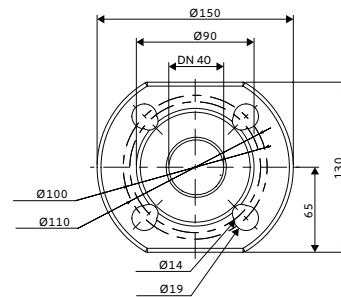
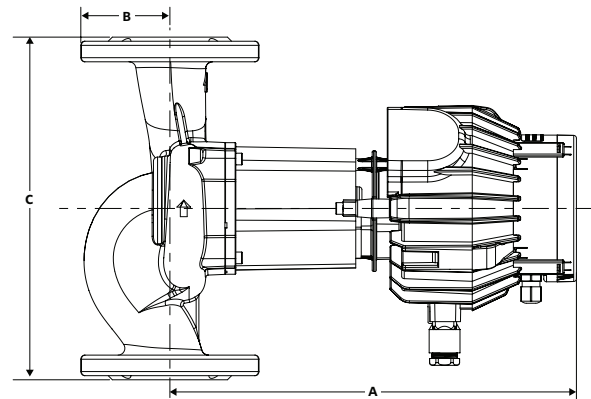
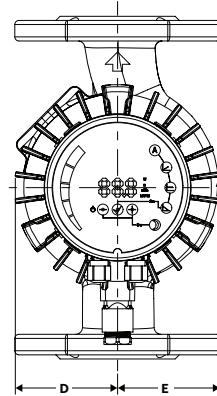
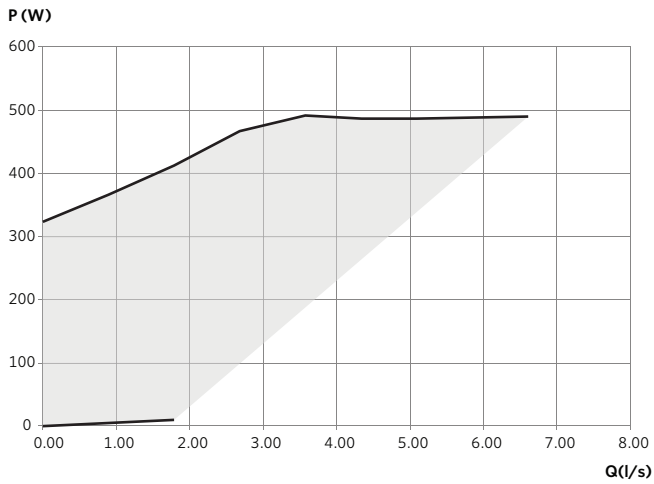
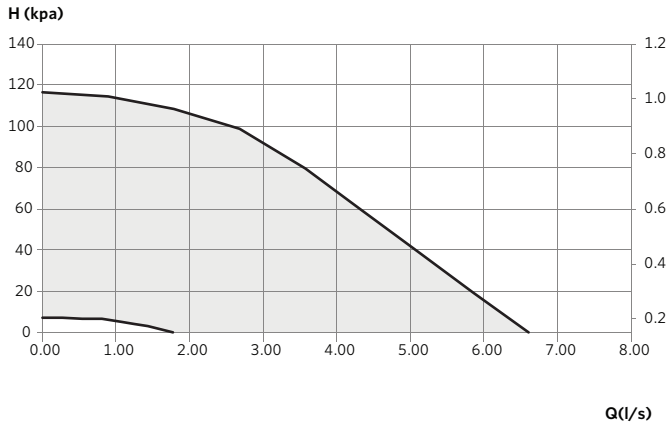

**TORONTO**  
+1 416 755 2291

**BUFFALO**  
+1 716 693 8813

**BIRMINGHAM**  
+44 (0) 8444 145 145

**MANCHESTER**  
+44 (0) 8444 145 145

**BANGALORE**  
+91 (0) 80 4906 3555

**SHANGHAI**  
+86 21 3756 6696

**SÃO PAULO**  
+55 11 4781 5500