

DESIGN ENVELOPE 4300 VIL | 3x3x5 (80-125) | 0305-003.0 | SUBMITTAL

File No: 101.5023
Date: MARCH 25, 2021
Supersedes: 101.5023
Date: APRIL 18, 2018

Job: _____ Representative: _____
 _____ Order No: _____ Date: _____
 Engineer: _____ Submitted by: _____ Date: _____
 Contractor: _____ Approved by: _____ Date: _____

PUMP DESIGN DATA

No. of pumps: _____ Tag: _____
 Capacity: _____ USgpm (L/s) Head: _____ ft (m)
 Liquid: _____ Viscosity: _____
 Temperature: _____ °F (°C) Specific gravity: _____
 Suction: 3" (80 mm) Discharge: 3" (80 mm)

UL STD 778 & CSA STD C22.2 NO.108 certified

Test report is supplied with each pump

MATERIALS OF CONSTRUCTION

- ANSI 125**
CONSTRUCTION: LPDESF
 E-coated ductile iron A536 Gr 65-45-12, stainless fitted
- ANSI 250**
CONSTRUCTION: HPDESF
 E-coated ductile iron A536 Gr 120-90-2, stainless fitted

MAXIMUM PUMP OPERATING CONDITIONS

- ANSI 125**
 175 psig at 150°F (12 bar at 65°C)
 100 psig at 300°F (7 bar at 150°C)
- ANSI 250**
 375 psig at 150°F (26 bar at 65°C)
 260 psig at 300°F (21 bar at 150°C)

MECHANICAL SEAL DESIGN DATA

See file no. 43.50 for standard mechanical seal details as indicated below

Armstrong seal reference number

- c1 (a) Others: _____

DEPM MOTOR AND CONTROL DATA

HP: 3
RPM: 3000
Motor enclosure: TEFC
Volts: _____
Phase: 3
Efficiency: IE5
Orientation: L5 (default) L6
Protocol (standard): BACnet™ MS/TP BACnet™ TCP/IP
 Modbus RTU
Control enclosure: Indoor - UL TYPE 12
 Outdoor - UL TYPE 4X
Fused disconnect switch: Consult factory
EMI/RFI control: Integrated filter designed to meet EN61800-3
Harmonic suppression: Equivalent: 5% AC line reactor - Supporting IEEE 519-1992 requirements**
Cooling: Fan-cooled, surface cooling
Ambient temperature: -10°C to +45°C up to 1000 meters above sea level (+14°F to +113°F, 3300 ft)
Analog I/O: Two inputs, one output. Output can be configured for voltage or current
Digital I/O: Two inputs, two outputs. Outputs can be configured as inputs
Relay outputs: Two programmable
Communication port: 1-RS485

** If supplied with the system electrical details, Armstrong will run a computer simulation of the system wide harmonics. If system harmonic levels are exceeded Armstrong can also recommend additional harmonic mitigation and the costs for such mitigation.

FLOW READOUT ACCURACY

The Design Envelope model selected will provide flow reading on the controls local keypad & digitally for the BMS. The model readout will be factory tested to ensure ±5% accuracy.

OPTIONS

SENSORLESS BUNDLE (STANDARD)



Operation of pump without a remote sensor. Includes:

- Sensorless control
- Flow readout
- Constant flow
- Constant pressure

Minimum system pressure to be maintained _____ ft (m)

* If minimum maintained system pressure is not known: Default to 40% of design head

PARALLEL SENSORLESS



Operation of multiple pumps without a remote sensor

Minimum system pressure to be maintained _____ ft (m)

* If minimum maintained system pressure is not known: Default to 40% of design head

ENERGY PERFORMANCE BUNDLE



Provides energy savings on oversized systems by adjusting pump parameters to on-site conditions. Includes:

- **Auto-flow balancing** - Automatically determines control curve between design flow at on-site system head, and minimum (zero-head) flow for energy savings
- **Maximum flow control** - Limits flow rate to pre-set maximum for potential energy savings

Maximum flow rate _____ gpm (L/s)

*Only available if sensorless bundle is enabled

*Available in single pump operation only

PROTECTION BUNDLE



Protects other flow sensitive equipment by setting limits of pump operation. Includes:

- **Minimum flow control** - Attempts to maintain flow rate to pre-set minimum to protect equipment in system
- **Bypass valve control** - Actuates a bypass valve to protect flow sensitive equipment if pre-set minimum flow rate is reached

Minimum flow rate _____ gpm (L/s)

*Only available if sensorless bundle is enabled

DUAL SEASON SETUP



Pre-sets heating and cooling parameters for pumps in 2-pipe systems

Cooling

Duty point _____ gpm (L/s) at _____ ft (m)

Minimum system pressure to be maintained _____ ft (m)

Heating

Duty point _____ gpm (L/s) at _____ ft (m)

Minimum system pressure to be maintained _____ ft (m)

*Available in single pump operation only

OPTIONAL SERVICES

ON-SITE PUMP COMMISSIONING



PUMP MANAGER



Online service for sustained pump performance and enhanced reliability.

Available in 3 or 5 year terms

* Requires an internet connection to be provided by building

* Includes an extended warranty for parts and labour (wearable parts excluded)

3

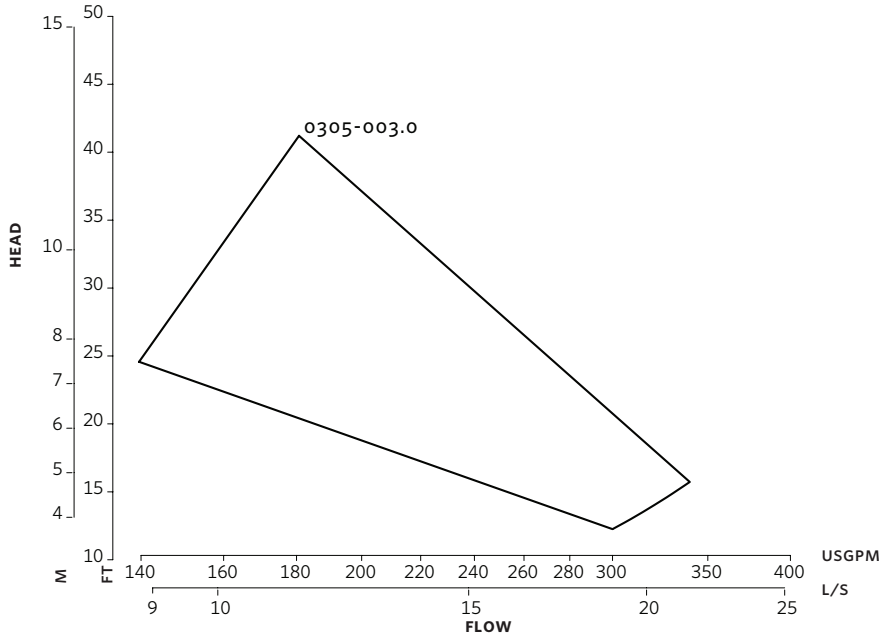

DIMENSION DATA

	INDOOR (UL TYPE 12/TEFC)	OUTDOOR (UL TYPE 4X/TEFC)
Size:	3×3×5	3×3×5
HP:	3	3
RPM:	3000	3000
AB:	21.10 (536)	23.31 (592)
B:	4.81 (122)	4.81 (122)
C:	3.65 (93)	3.65 (93)
CI:	-	5.00 (127)
D:	8.01 (203)	8.01 (203)
E:	8.20 (208)	8.62 (219)
S:	9.25 (235)	9.25 (235)
SD:	17.26 (438)	17.26 (438)
T:	5.00 (127)	5.00 (127)
Weight:	111 (50.3)	111 (50.3)

Dimensions - inch (mm)
Weight - lbs (kg)

Performance curves are for reference only.
Confirm current performance data with Armstrong ADEPT Quote or ADEPT Select selection software.

- Tolerance of ±0.125" (±3 mm) should be used
- For exact installation, data please write factory for certified dimensions

INDOOR

OUTDOOR

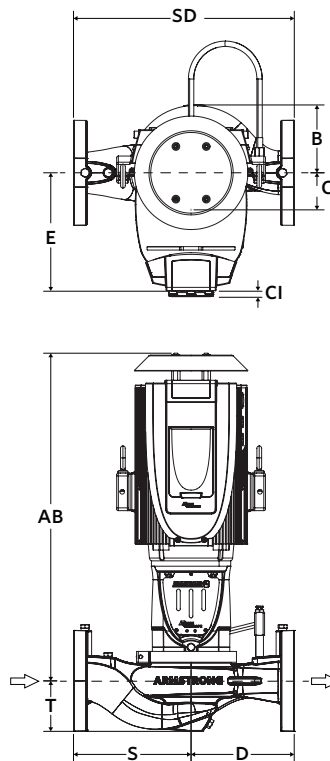
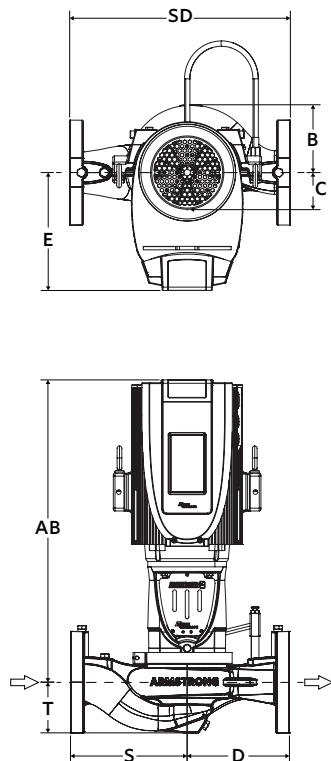

CONTROL ORIENTATIONS

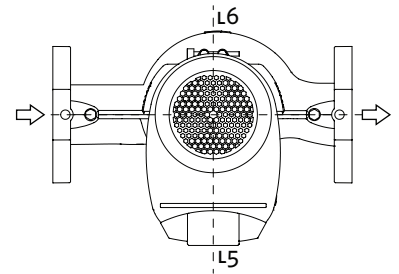

TORONTO

23 BERTRAND AVENUE
TORONTO, ONTARIO
CANADA, M1L 2P3
+1 416 755 2291

BUFFALO

93 EAST AVENUE
NORTH TONAWANDA, NEW YORK
U.S.A., 14120-6594
+1 716 693 8813

DROITWICH SPA

POINTON WAY,
STONEBRIDGE CROSS BUSINESS PARK
DROITWICH SPA, WORCESTERSHIRE
UNITED KINGDOM, WR9 0LW
+44 8444 145 145

MANCHESTER

WOLVERTON STREET
MANCHESTER
UNITED KINGDOM, M11 2ET
+44 8444 145 145

BANGALORE

#59, FIRST FLOOR, 3RD MAIN
MARGOSA ROAD, MALLESWARAM
BANGALORE, INDIA, 560 003
+91 80 4906 3555

SHANGHAI

UNIT 903, 888 NORTH SICHUAN RD.
HONGKOU DISTRICT, SHANGHAI
CHINA, 200085
+86 21 5237 0909

SÃO PAULO

RUA JOSÉ SEMIÃO RODRIGUES AGOSTINHO,
1370 GALPÃO 6 EMBU DAS ARTES
SAO PAULO, BRAZIL
+55 11 4785 1330

LYON

93 RUE DE LA VILLETTE
LYON, 69003 FRANCE
+33 4 26 83 78 74

DUBAI

JAFZA VIEW 19, OFFICE 402
P.O.BOX 18226 JAFZA,
DUBAI - UNITED ARAB EMIRATES
+971 4 887 6775

MANNHEIM

DYNAMOSTRASSE 13
68165 MANNHEIM
GERMANY
+49 621 3999 9858

JIMBOLIA

STR CALEA MOTILOR NR 2C
PO: 305400, JIMBOLIA
ROMANIA
+40 256 360 030

ARMSTRONG FLUID TECHNOLOGY
ESTABLISHED 1934

ARMSTRONGFLUIDTECHNOLOGY.COM