

DESIGN ENVELOPE 4300 VIL SINGLE PHASE | 0306-001.5 | SUBMITTAL

File No: 100.4281
Date: OCTOBER 27, 2014
Supersedes: NEW
Date: NEW

Job: _____ Representative: _____

Order No: _____ Date: _____

Engineer: _____ Submitted by: _____ Date: _____

Contractor: _____ Approved by: _____ Date: _____

PUMP DESIGN DATA

No. of pumps: _____ Tag: _____
Capacity: _____ USgpm (L/s) Head: _____ ft (m)
Liquid: _____ Viscosity: _____
Temperature: _____ °F (°C) Specific gravity: _____
Suction: 3" (75mm) Discharge: 3" (75mm)

MOTOR DESIGN DATA

HP: 1.5 RPM: 1740 Frame size: _____
Enclosure: _____ Volts: 208 Freq: 60 Hz
Phase: 3 Efficiency: NEMA premium

MAXIMUM PUMP OPERATING CONDITIONS

ANSI 125

175 psig at 150°F (12 bars at 65°C)
100 psig at 300°F (7 bars at 150°C)

ANSI 250

375 psig at 150°F (26 bars at 65°C)
260 psig at 300°F (21 bars at 150°C)

- Tolerance of ±0.125" (±3 mm) should be used
- For exact installation, data please write factory for certified dimensions

MECHANICAL SEAL DESIGN DATA

See file no. 43.50 for standard mechanical seal details as indicated below

Armstrong seal reference number

A1 (C) Others: _____

CONTROLS DATA

Power supply: Volts: 200-240VAC
Freq: 50/60Hz Phase: 1

Sensorless Control: Standard

Minimum system pressure to be maintained: _____ ft (m)*

Orientation: L1 (default) L2 L3 L4

Protocol (standard): Modbus RTU BACnet™ MS/TP
 Johnson® N2 Siemens® FLN

Protocol (optional): LonWorks®

Enclosure: Indoor - UL TYPE 12
 Outdoor - UL TYPE 4X with Weather Shield
 Outdoor - UL TYPE 4X less Weather Shield

Disconnect switch: Non-fused

EMI/RFI control: 1-phase IVS102 units do not meet the EN61800-3 directive

Harmonic suppression: Dual DC-link reactors (Equivalent: 5% AC line reactor) Supporting IEEE 519-1992 requirements**

Cooling: Fan-cooled through back channel

Ambient temperature: -10°C to +45°C up to 1000 meters above sea level (-14°F to +113°F, 3300 ft)

Analog I/O: Two current or voltage inputs, one current output

Digital I/O: Six programmable inputs (two can be configured as outputs)

Pulse inputs: Two programmable

Relay outputs: Two programmable

Communication port: 1-RS485, 1-USB

*If minimum maintained system pressure is not known: Default to 40% of design head
**The IVS 102 drive is a low harmonic drive via built-in DC line reactors. This does not guaranty performance to any system wide harmonic specification or the costs to meet a system wide specification. If supplied with the system electrical details, Armstrong will run a computer simulation of the system wide harmonics. If system harmonic levels are exceeded Armstrong can also recommend additional harmonic mitigation and the costs for such mitigation.

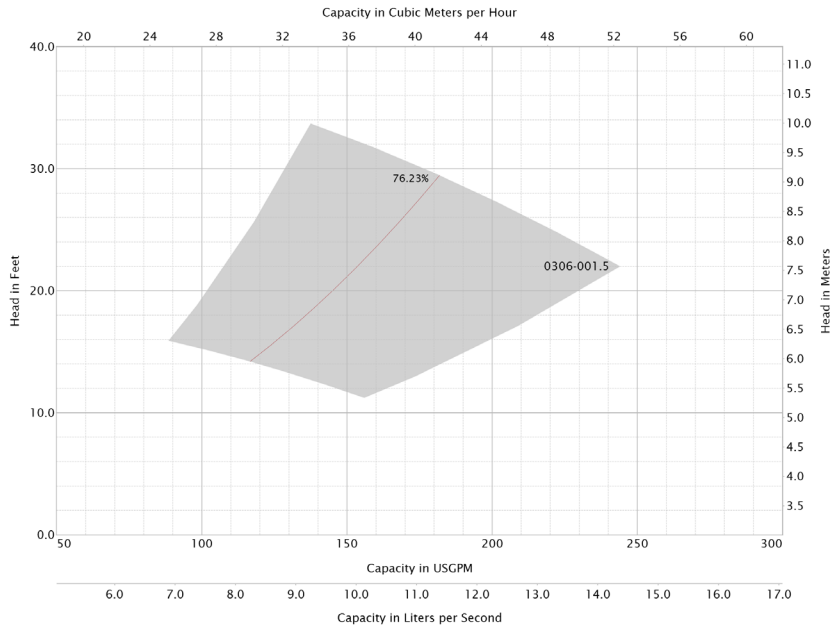

DIMENSION DATA

	INDOOR (UL TYPE 12/ODP)	OUTDOOR (UL TYPE 4X/TEFC)
Frame size:	145	145
Size:	3×3×6	3×3×6
HP:	1.5	1.5
RPM:	1740	1740
AB:	23.83(605)	29.96(761)
B:	5.80(147)	5.80(147)
C:	4.65(118)	4.65(118)
D:	8.25(210)	8.25(210)
E:	12.04(306)	17.19 (437)
F:	12.04(306)	17.19 (437)
P:	8.63(219)	7.28(185)
S:	9.75(248)	9.75(248)
SD:	18.00(457)	18.00(457)
T:	6.06(154)	6.06(154)
XY:	22.03(560)	20.53(521)
Weight:	219(99.3)	227(103.0)

Performance curves are for reference only.
Confirm current performance data with Armstrong ACE Online selection software.

Dimensions - inch (mm)
Weight - lbs (kg)

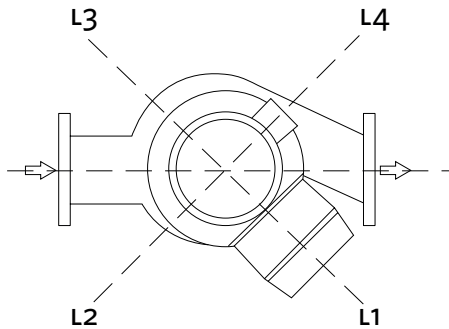

TORONTO
+1 416 755 2291

BUFFALO
+1 716 693 8813

BIRMINGHAM
+44 (0) 8444 145 145

MANCHESTER
+44 (0) 8444 145 145

BANGALORE
+91 (0) 80 4906 3555

SHANGHAI
+86 21 3756 6696

