

DESIGN ENVELOPE 4300 VIL | 50-125 (2x2x5) | 5012-002.2 | SUBMITTAL

File No: 101.5005IEC
Date: MARCH 25, 2021
Supersedes: 101.5005IEC
Date: SEPTEMBER 30, 2019

Job: _____ Representative: _____

_____ Order No: _____ Date: _____

Engineer: _____ Submitted by: _____ Date: _____

Contractor: _____ Approved by: _____ Date: _____

PUMP DESIGN DATA

No. of pumps: _____ Tag: _____

Capacity: _____ L/s (USgpm) Head: _____ m (ft)

Liquid: _____ Viscosity: _____

Temperature: _____ °C (°F) Specific gravity: _____

Suction: 50 mm (2") Discharge: 50 mm (2")

MEI ≥ 0.70

MATERIALS OF CONSTRUCTION

PN 16

CONSTRUCTION: LPDESF

E-coated ductile iron A536 Gr 65-45-12, stainless fitted

PN 25

CONSTRUCTION: HPDESF

E-coated ductile iron A536 Gr 120-90-2, stainless fitted

MAXIMUM PUMP OPERATING CONDITIONS

PN 16

16 bars at 49°C (232 psig at 120°F)

7 bars at 150°C (100 psig at 300°F)

PN 25

25 bars at 65°C (362 psig at 149°F)

21 bars at 150°C (304 psig at 300°F)

MECHANICAL SEAL DESIGN DATA

See file no. 43.50 for standard mechanical seal details as indicated below

Armstrong seal reference number

c1 (a) Others: _____

FLOW READOUT ACCURACY

The Design Envelope model selected will provide flow reading on the controls local keypad & digitally for the BMS. The model readout will be factory tested to ensure ±5% accuracy.

DEPM MOTOR AND CONTROL DATA

kW: 2.2

RPM: 3000

Motor enclosure: TEFC

Volts: _____

Phase: 3

Efficiency: IE5

Orientation: L5 (default) L6

Protocol (standard): BACnet™ MS/TP

BACnet™ TCP/IP

Modbus RTU

Control enclosure: Indoor - IP 55

Outdoor - IP 66

Fused disconnect switch: Consult factory

EMI/RFI control: Integrated filter designed to meet EN61800-3

Harmonic suppression: Equivalent: 5% AC line reactor - Supporting IEEE 519-1992 requirements**

Cooling: Fan-cooled, surface cooling

Ambient temperature: -10°C to +45°C up to 1000 meters above sea level (+14°F to +113°F, 3300 ft)

Analog I/O: Two inputs, one output. Output can be configured for voltage or current

Digital I/O: Two inputs, two outputs. Outputs can be configured as inputs

Relay outputs: Two programmable

Communication port: 1-RS485

** If supplied with the system electrical details, Armstrong will run a computer simulation of the system wide harmonics. If system harmonic levels are exceeded Armstrong can also recommend additional harmonic mitigation and the costs for such mitigation.

OPTIONS

SENSORLESS BUNDLE (STANDARD)



Operation of pump without a remote sensor. Includes:

- Sensorless control
- Flow readout
- Constant flow
- Constant pressure

Minimum system pressure to be maintained _____ m (ft)

* If minimum maintained system pressure is not known:
Default to 40% of design head

PARALLEL SENSORLESS



Operation of multiple pumps without a remote sensor

Minimum system pressure to be maintained _____ m (ft)

* If minimum maintained system pressure is not known:
Default to 40% of design head

ENERGY PERFORMANCE BUNDLE



Provides energy savings on oversized systems by adjusting pump parameters to on-site conditions. Includes:

- **Auto-flow balancing** - Automatically determines control curve between design flow at on-site system head, and minimum (zero-head) flow for energy savings
- **Maximum flow control** - Limits flow rate to pre-set maximum for potential energy savings

Maximum flow rate _____ L/s (gpm)

*Only available if sensorless bundle is enabled

*Available in single pump operation only

PROTECTION BUNDLE



Protects other flow sensitive equipment by setting limits of pump operation. Includes:

- **Minimum flow control** - Attempts to maintain flow rate to pre-set minimum to protect equipment in system
- **Bypass valve control** - Actuates a bypass valve to protect flow sensitive equipment if pre-set minimum flow rate is reached

Minimum flow rate _____ L/s (gpm)

*Only available if sensorless bundle is enabled

DUAL SEASON SETUP



Pre-sets heating and cooling parameters for pumps in 2-pipe systems

Cooling

Duty point _____ L/s (gpm) at _____ m (ft)

Minimum system pressure to be maintained _____ m (ft)

Heating

Duty point _____ L/s (gpm) at _____ m (ft)

Minimum system pressure to be maintained _____ m (ft)

*Available in single pump operation only

OPTIONAL SERVICES

ON-SITE PUMP COMMISSIONING



PUMP MANAGER



Online service for sustained pump performance and enhanced reliability.

Available in 3 or 5 year terms

* Requires an internet connection to be provided by building

* Includes an extended warranty for parts and labour (wearable parts excluded)

3

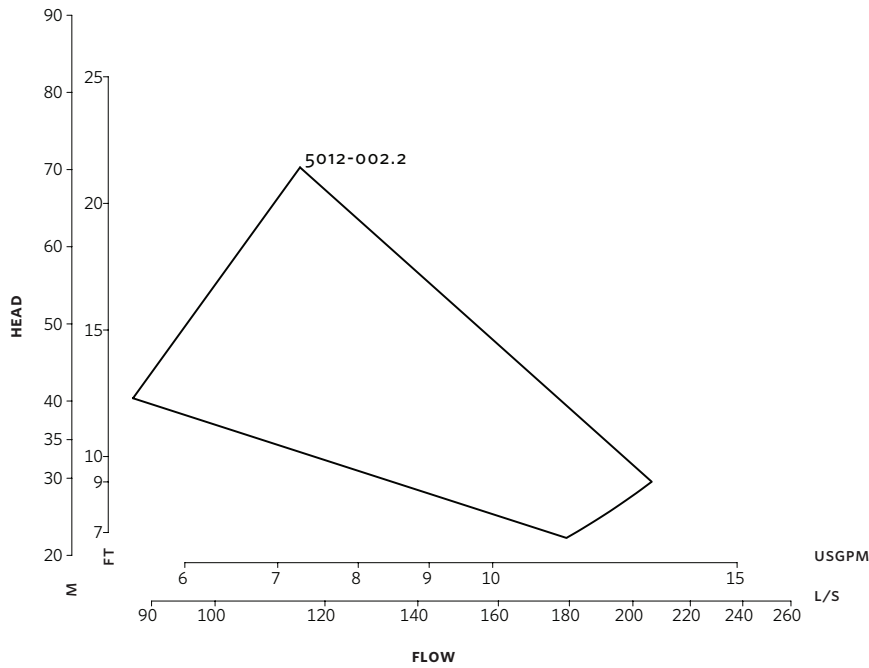

DIMENSION DATA

	INDOOR (IP55/TEFC)	OUTDOOR (IP66/TEFC)
Size:	50-125	50-125
kW:	2.2	2.2
RPM:	3000	3000
AB:	531 (20.90)	587 (23.12)
B:	109 (4.30)	109 (4.30)
C:	89 (3.50)	89 (3.50)
CI:	-	127 (5.00)
D:	153 (6.02)	153 (6.02)
E:	208 (8.20)	219 (8.62)
S:	178 (7.01)	178 (7.01)
SD:	331 (13.03)	331 (13.03)
T:	79 (3.12)	79 (3.12)
Weight:	45.0 (99)	45.0 (99)

Performance curves are for reference only.
Confirm current performance data with Armstrong ADEPT Quote or ADEPT Select selection software.

Dimensions - mm (inch)
Weight - kg (lbs)

- Tolerance of ± 3 mm (± 0.125 ") should be used
- For exact installation, data please write factory for certified dimensions

INDOOR

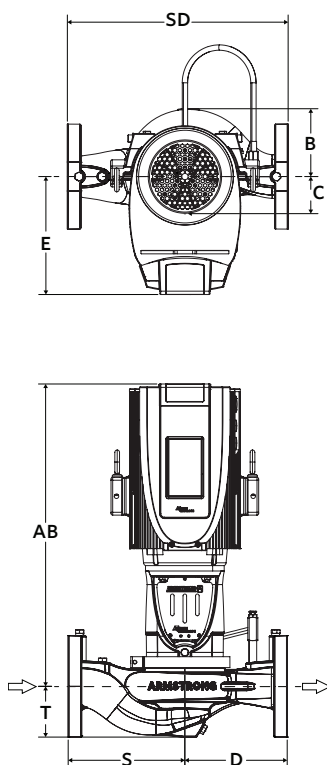

OUTDOOR

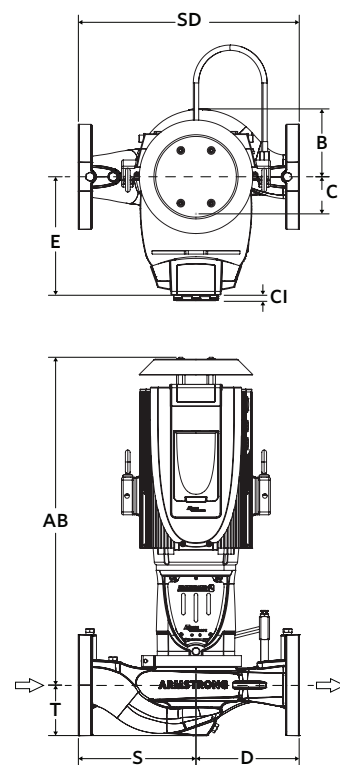

CONTROL ORIENTATIONS

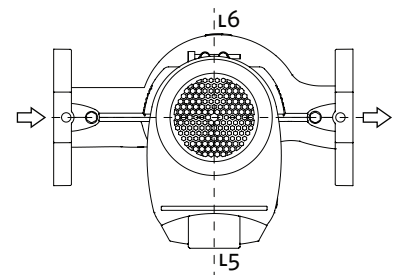

TORONTO

23 BERTRAND AVENUE
TORONTO, ONTARIO
CANADA, M1L 2P3
+1 416 755 2291

BUFFALO

93 EAST AVENUE
NORTH TONAWANDA, NEW YORK
U.S.A., 14120-6594
+1 716 693 8813

DROITWICH SPA

POINTON WAY,
STONEBRIDGE CROSS BUSINESS PARK
DROITWICH SPA, WORCESTERSHIRE
UNITED KINGDOM, WR9 0LW
+44 8444 145 145

MANCHESTER

WOLVERTON STREET
MANCHESTER
UNITED KINGDOM, M11 2ET
+44 8444 145 145

BANGALORE

#59, FIRST FLOOR, 3RD MAIN
MARGOSA ROAD, MALLESWARAM
BANGALORE, INDIA, 560 003
+91 80 4906 3555

SHANGHAI

UNIT 903, 888 NORTH SICHUAN RD.
HONGKOU DISTRICT, SHANGHAI
CHINA, 200085
+86 21 5237 0909

SÃO PAULO

RUA JOSÉ SEMIÃO RODRIGUES AGOSTINHO,
1370 GALPÃO 6 EMBU DAS ARTES
SAO PAULO, BRAZIL
+55 11 4785 1330

LYON

93 RUE DE LA VILLETTE
LYON, 69003 FRANCE
+33 4 26 83 78 74

DUBAI

JAFZA VIEW 19, OFFICE 402
P.O.BOX 18226 JAFZA,
DUBAI - UNITED ARAB EMIRATES
+971 4 887 6775

MANNHEIM

DYNAMOSTRASSE 13
68165 MANNHEIM
GERMANY
+49 621 3999 9858

JIMBOLIA

STR CALEA MOTILOR NR. 2C
JIMBOLIA 305400, JUD.TIMIS
ROMANIA
+40 256 360 030

ARMSTRONG FLUID TECHNOLOGY
ESTABLISHED 1934

ARMSTRONGFLUIDTECHNOLOGY.COM