

DESIGN ENVELOPE 4300 VIL | 1217-350.0 | SUBMITTAL

File No: 101.5351
Date: AUGUST 1, 2018
Supersedes: 101.5205
Date: MARCH 30, 2018

Job: _____ Representative: _____
 _____ Order No: _____ Date: _____
 Engineer: _____ Submitted by: _____ Date: _____
 Contractor: _____ Approved by: _____ Date: _____

PUMP DESIGN DATA

No. of pumps: _____ Tag: _____
 Capacity: _____ USgpm (L/s) Head: _____ ft (m)
 Liquid: _____ Viscosity: _____
 Temperature: _____ °F (°C) Specific gravity: _____
 Suction: 12" (300 mm) Discharge: 12" (300 mm)

OSHDP Seismic Certification OSP-0422-10
UL STD 778 & CSA STD C22.2 NO.108 certified
Test report is supplied with each pump

MOTOR DESIGN DATA

HP: _____ RPM: _____ Frame size: _____ Enclosure: _____
 Volts: _____ Hertz: 60 Hz Phase: 3
 Efficiency: NEMA premium 12.12

MAXIMUM PUMP OPERATING CONDITIONS

ANSI 125 - (CONSTRUCTION: BF)

175 psig at 150°F (12 bar at 65°C)
 100 psig at 300°F (7 bar at 150°C)

ANSI 250 - (CONSTRUCTION: DBF)

375 psig at 150°F (26 bar at 65°C)
 260 psig at 300°F (21 bar at 150°C)

MECHANICAL SEAL DESIGN DATA

See file no. 43.50 for standard mechanical seal details as indicated below

Armstrong seal reference number

c1 (a) Others: _____

FLOW READOUT ACCURACY

The Design Envelope model selected will provide flow reading on the controls local keypad & digitally for the VMS. The model readout will be factory tested to ensure ±5% accuracy.

CONTROLS DATA

Orientation: L1 (default) L2 L3 L4

Protocol (standard): BACnet™ MS/TP
 BACnet™ TCP/IP
 Modbus RTU

Enclosure: Indoor - UL TYPE 12

Fused disconnect switch: N/A

EMI/RFI control: Integrated filter designed to meet EN61800-3

Harmonic suppression: Dual DC-link reactors (Equivalent: 5% AC line reactor) Supporting IEEE 519-1992 requirements**

Cooling: Fan-cooled through back channel

Ambient temperature: -10°C to +45°C up to 1000 meters above sea level (+14°F to +113°F, 3300 ft)

Analog I/O: Two current or voltage inputs, one speed output

Digital I/O: Two inputs, two outputs

Pulse inputs: Two programmable

Relay outputs: Two programmable

Communication port: 1-RS485

**The IVS drive is a low harmonic drive via built-in DC line reactors. This does not guaranty performance to any system wide harmonic specification or the costs to meet a system wide specification. If supplied with the system electrical details, Armstrong will run a computer simulation of the system wide harmonics. If system harmonic levels are exceeded Armstrong can also recommend additional harmonic mitigation and the costs for such mitigation.

OPTIONS

SENSORLESS BUNDLE (STANDARD)



Operation of pump without a remote sensor. Includes:

- Sensorless control
- Flow readout
- Constant flow
- Constant pressure

Minimum system pressure to be maintained _____ ft (m)

* If minimum maintained system pressure is not known: Default to 40% of design head

□ PARALLEL SENSORLESS



Operation of multiple pumps without a remote sensor

Minimum system pressure to be maintained _____ ft (m)

* If minimum maintained system pressure is not known: Default to 40% of design head

□ ENERGY PERFORMANCE BUNDLE



Provides energy savings on oversized systems by adjusting pump parameters to on-site conditions. Includes:

- **Auto-flow balancing** – Automatically determines control curve between design flow at on-site system head, and minimum (zero-head) flow for energy savings
- **Maximum flow control** – Limits flow rate to pre-set maximum for potential energy savings

Maximum flow rate _____ gpm (L/s)

*Only available if sensorless bundle is enabled

□ PROTECTION BUNDLE



Protects other flow sensitive equipment by setting limits of pump operation. Includes:

- **Minimum flow control** – Attempts to maintain flow rate to pre-set minimum to protect equipment in system
- **Bypass valve control** – Actuates a bypass valve to protect flow sensitive equipment if pre-set minimum flow rate is reached

Minimum flow rate _____ gpm (L/s)

*Only available if sensorless bundle is enabled

□ ZONE OPTIMIZATION BUNDLE



Controls pumps to ensure multiple zones are satisfied for heating or cooling

- **2 sensor control** – Controls pumps in a 2-zone application to ensure both zones are always satisfied for heating or cooling

□ DUAL SEASON SETUP



Pre-sets heating and cooling parameters for pumps in 2-pipe systems

Cooling

Duty point _____ gpm (L/s) at _____ ft (m)

Minimum system pressure to be maintained _____ ft (m)

Heating

Duty point _____ gpm (L/s) at _____ ft (m)

Minimum system pressure to be maintained _____ ft (m)

OPTIONAL SERVICES

ON-SITE PUMP COMMISSIONING



Where purchased and applicable, onsite commissioning by an Armstrong representative will include setting up communication with the Pump (not wiring to BAS), adjusting parameters to match on-site conditions, register the pumps for enhanced warranty and connect the pumps to the router as part of the activation of Pump Manager.

PUMP MANAGER



As a Performance Management Service, Pump Manager is an online automated fault detection and diagnostic service for sustained performance and enhanced reliability. It includes advanced trending, alerts of variance in performance and automated reports.

Available in yearly increments. Includes an option for a price discount on the Extended Warranty Service.

*The Service requires an active internet connection.

3

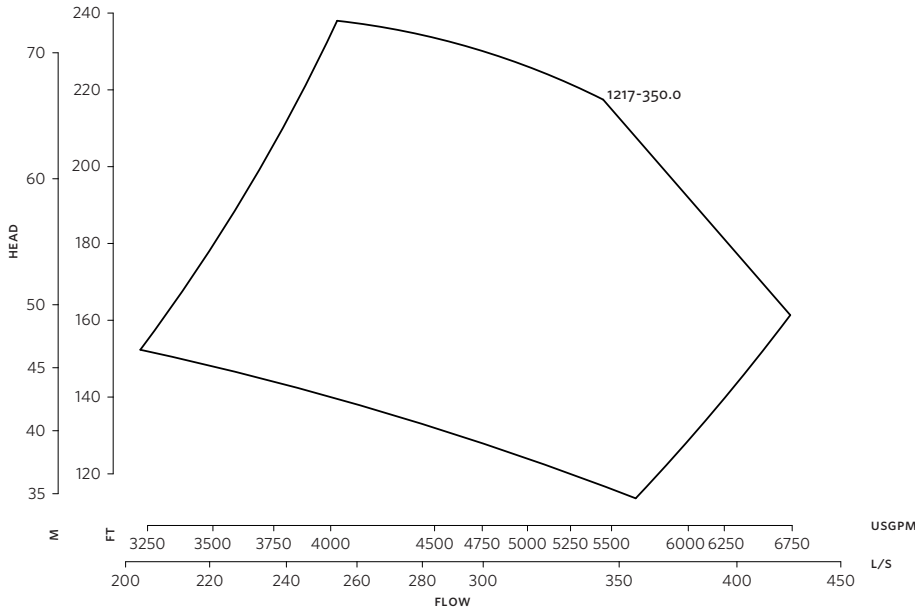

DIMENSION DATA

INDOOR (UL TYPE 12/ODP)

- Size:** 12×12×17
- HP:** 350
- RPM:** 1780
- AB:** 64.87(1648)
- B:** 17.50(445)
- C:** 13.20(335)
- D:** 27.00(686)
- E:** 25.05(636)
- P:** 22.44(570)
- F:** 25.05(636)
- S:** 25.00(635)
- SD:** 52.00(1321)
- T:** 13.80(351)
- XY:** 64.83(1647)
- Weight:** 4810(2181.8)

Performance curves are for reference only.
Confirm current performance data with Armstrong ACE Online selection software.

Dimensions - inch (mm)
Weight - lbs (kg)

INDOOR

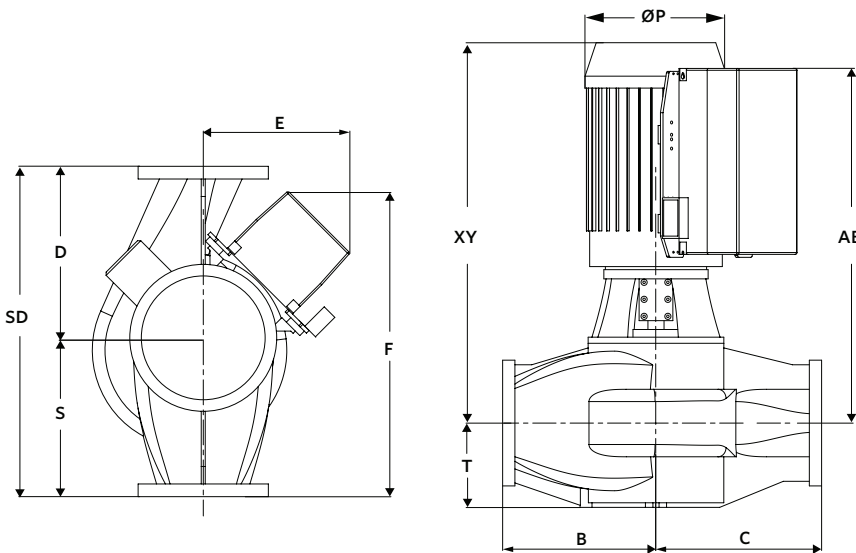

- Tolerance of ±0.125" (±3 mm) should be used
- For exact installation, data please write factory for certified dimensions

CONTROL ORIENTATIONS

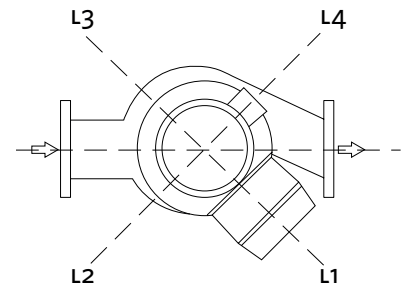

TORONTO

23 BERTRAND AVENUE
TORONTO, ONTARIO
CANADA
M1L 2P3
+1 416 755 2291

BUFFALO

93 EAST AVENUE
NORTH TONAWANDA, NEW YORK
U.S.A.
14120-6594
+1 716 693 8813

BIRMINGHAM

HEYWOOD WHARF, MUCKLOW HILL
HALESOWEN, WEST MIDLANDS
UNITED KINGDOM
B62 8DJ
+44 (0) 8444 145 145

MANCHESTER

WOLVERTON STREET
MANCHESTER
UNITED KINGDOM
M11 2ET
+44 (0) 8444 145 145

BANGALORE

#59, FIRST FLOOR, 3RD MAIN
MARGOSA ROAD, MALLESWARAM
BANGALORE, INDIA
560 003
+91 (0) 80 4906 3555

SHANGHAI

UNIT 903, 888 NORTH SICHUAN RD.
HONGKOU DISTRICT, SHANGHAI
CHINA
200085
+86 (0) 21 5237 0909

SÃO PAULO

RUA JOSÉ SEMIÃO RODRIGUES AGOSTINHO,
1370 GALPÃO 6
EMBU DAS ARTES
SAO PAULO, BRAZIL
+55 11 4785 1330

ARMSTRONG FLUID TECHNOLOGY
ESTABLISHED 1934

ARMSTRONGFLUIDTECHNOLOGY.COM

**MAKING
ENERGY
MAKE
SENSE™**