

**DESIGN ENVELOPE 4322 TANGO** |  
40-125 (1.5x1.5x5) | 4012-001.1 | **SUBMITTAL**

**File No:** 102.5074IEC  
**Date:** NOVEMBER 08, 2021  
**Supersedes:** NEW  
**Date:** NEW

Job: \_\_\_\_\_ Representative: \_\_\_\_\_  
\_\_\_\_\_  
Order No: \_\_\_\_\_ Date: \_\_\_\_\_  
Engineer: \_\_\_\_\_ Submitted by: \_\_\_\_\_ Date: \_\_\_\_\_  
Contractor: \_\_\_\_\_ Approved by: \_\_\_\_\_ Date: \_\_\_\_\_

**PUMP DESIGN DATA**

No. of pumps: \_\_\_\_\_ Tag: \_\_\_\_\_  
Total system design flow: \_\_\_\_\_ L/s (USgpm)  
Head: \_\_\_\_\_ m (ft) Capacity split \_\_\_\_\_ %  
Flow per pump head: \_\_\_\_\_ L/s (USgpm)  
Parallel flow: \_\_\_\_\_ L/s (USgpm)  
Liquid: \_\_\_\_\_ Viscosity: \_\_\_\_\_  
Temperature: \_\_\_\_\_ °C (°F) Specific gravity: \_\_\_\_\_  
Suction: 40 mm (1.5") Discharge: 40 mm (1.5")  
MEI ≥ 0.70

**MATERIALS OF CONSTRUCTION**

**PN 16**  
CONSTRUCTION: LPDEF  
E-coated ductile iron A536 Gr 65-45-12, stainless fitted  
 **PN 25**  
CONSTRUCTION: HPDEF  
E-coated ductile iron A536 Gr 120-90-2, stainless fitted

**MAXIMUM PUMP OPERATING CONDITIONS**

**PN 16**  
16 bars at 49°C (232 psig at 120°F)  
7 bars at 150°C (100 psig at 300°F)  
 **PN 25**  
25 bars at 65°C (362 psig at 149°F)  
21 bars at 150°C (304 psig at 300°F)

**MECHANICAL SEAL DESIGN DATA**

See file no. 43.50 for standard mechanical seal details as indicated below  
Armstrong seal reference number  
 c1 (a)  Others: \_\_\_\_\_

**FLOW READOUT ACCURACY**

The Design Envelope model selected will provide flow reading on the controls local keypad & digitally for the BMS. The model readout will be factory tested to ensure ±5% accuracy.

**DEPM MOTOR AND CONTROL DATA**

**kW:** 1.1  
**RPM:** 3000  
**Motor enclosure:** TEFC  
**Volts /Phase:**  200-240V/1ph  380-480V/3ph  
For 200-240V/3ph or 575V/3ph, see File #: 102.5061IEC  
**Efficiency:** IE5  
**Orientation:** Standard  
**Protocol (standard):**  BACnet™ MS/TP  
 BACnet™ TCP/IP  
 Modbus RTU  
**Control enclosure:**  Indoor - IP 55  
 Outdoor - IP 66  
**Fused disconnect switch:** See File 100.8131  
**EMI/RFI control:** Integrated filter designed to meet EN61800-3  
**Harmonic suppression:** Equivalent: 5% AC line reactor - Supporting IEEE 519-1992 requirements\*\*  
**Cooling:** Fan-cooled, surface cooling  
**Ambient temperature:** -10°C to +40°C up to 1000 meters above sea level (+14°F to +104°F, 3300 ft)  
**Analog I/O:** Two inputs, one output. Output can be configured for voltage or current  
**Digital I/O:** Two inputs, two outputs. Outputs can be configured as inputs  
**Relay outputs:** Two programmable  
**Communication port:** 1-RS485

\*\* If supplied with the system electrical details, Armstrong will run a computer simulation of the system wide harmonics. If system harmonic levels are exceeded Armstrong can also recommend additional harmonic mitigation and the costs for such mitigation.

## OPTIONS

### SENSORLESS BUNDLE (STANDARD)



Operation of pump without a remote sensor. Includes:

- Sensorless control
- Flow readout
- Constant flow
- Constant pressure

Minimum system pressure to be maintained \_\_\_\_\_ m (ft)

\* If minimum maintained system pressure is not known:  
Default to 40% of design head

### PARALLEL SENSORLESS



Operation of multiple pumps without a remote sensor

Minimum system pressure to be maintained \_\_\_\_\_ m (ft)

\* If minimum maintained system pressure is not known:  
Default to 40% of design head

### ENERGY PERFORMANCE BUNDLE



Provides energy savings on oversized systems by adjusting pump parameters to on-site conditions. Includes:

- **Auto-flow balancing** - Automatically determines control curve between design flow at on-site system head, and minimum (zero-head) flow for energy savings
- **Maximum flow control** - Limits flow rate to pre-set maximum for potential energy savings

Maximum flow rate \_\_\_\_\_ L/s (gpm)

\*Only available if sensorless bundle is enabled

\*Available in single pump operation only

### PROTECTION BUNDLE



Protects other flow sensitive equipment by setting limits of pump operation. Includes:

- **Minimum flow control** - Attempts to maintain flow rate to pre-set minimum to protect equipment in system
- **Bypass valve control** - Actuates a bypass valve to protect flow sensitive equipment if pre-set minimum flow rate is reached

Minimum flow rate \_\_\_\_\_ L/s (gpm)

\*Only available if sensorless bundle is enabled

### DUAL SEASON SETUP



Pre-sets heating and cooling parameters for pumps in 2-pipe systems

#### Cooling

Duty point \_\_\_\_\_ L/s (gpm) at \_\_\_\_\_ m (ft)

Minimum system pressure to be maintained \_\_\_\_\_ m (ft)

#### Heating

Duty point \_\_\_\_\_ L/s (gpm) at \_\_\_\_\_ m (ft)

Minimum system pressure to be maintained \_\_\_\_\_ m (ft)

\*Available in single pump operation only

## OPTIONAL SERVICES

### ON-SITE PUMP COMMISSIONING



### PUMP MANAGER



Online service for sustained pump performance and enhanced reliability.

Available in 3 or 5 year terms

\* Requires an internet connection to be provided by building

\* Includes an extended warranty for parts and labour (wearable parts excluded)

3

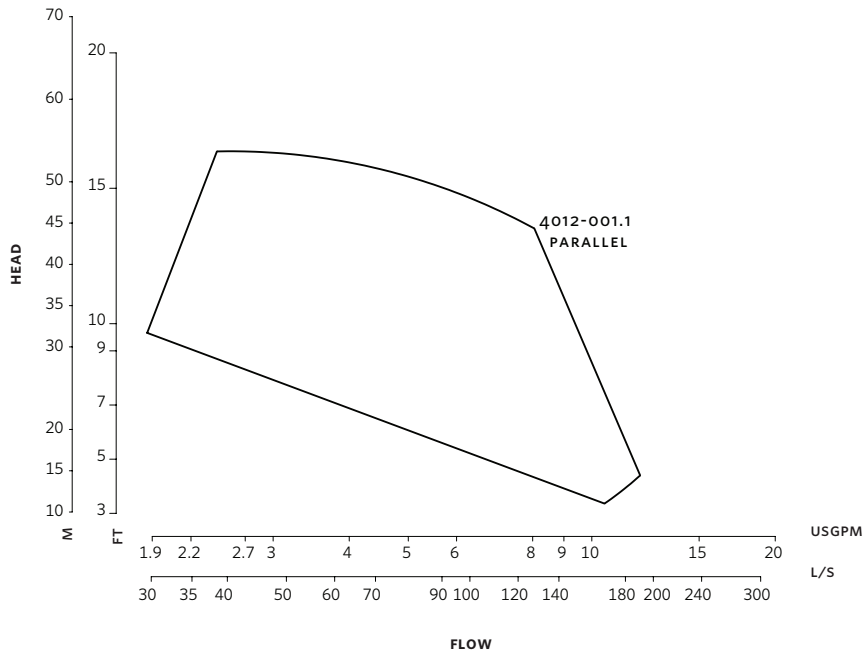

**DIMENSION DATA**

	INDOOR (IP55/TEFC)	OUTDOOR (IP66/TEFC)
<b>Size:</b>	40-125	40-125
<b>kW:</b>	1.1	1.1
<b>RPM:</b>	3000	3000
<b>Frame:</b>	71	71
<b>AB:</b>	435 (17.12)	464 (18.27)
<b>B1:</b>	149 (5.86)	149 (5.86)
<b>B2:</b>	149 (5.86)	149 (5.86)
<b>C1:</b>	279 (11.00)	279 (11.00)
<b>C2:</b>	279 (11.00)	279 (11.00)
<b>CI:</b>	-	70 (2.75)
<b>D:</b>	102 (4.00)	102 (4.00)
<b>E:</b>	152 (5.98)	162 (6.38)
<b>S:</b>	178 (7.02)	178 (7.02)
<b>SD:</b>	280 (11.02)	280 (11.02)
<b>T:</b>	89 (3.50)	89 (3.50)
<b>Weight:</b>	55.0 (121)	55.0 (121)

Dimensions - mm (inch)  
Weight - kg (lbs)

Performance curves are for reference only.  
Confirm current performance data with Armstrong ADEPT Quote or ADEPT Select selection software.

- Tolerance of  $\pm 3$  mm ( $\pm 0.125$ " ) should be used
- For exact installation, data please write factory for certified dimensions

**INDOOR**

**OUTDOOR**

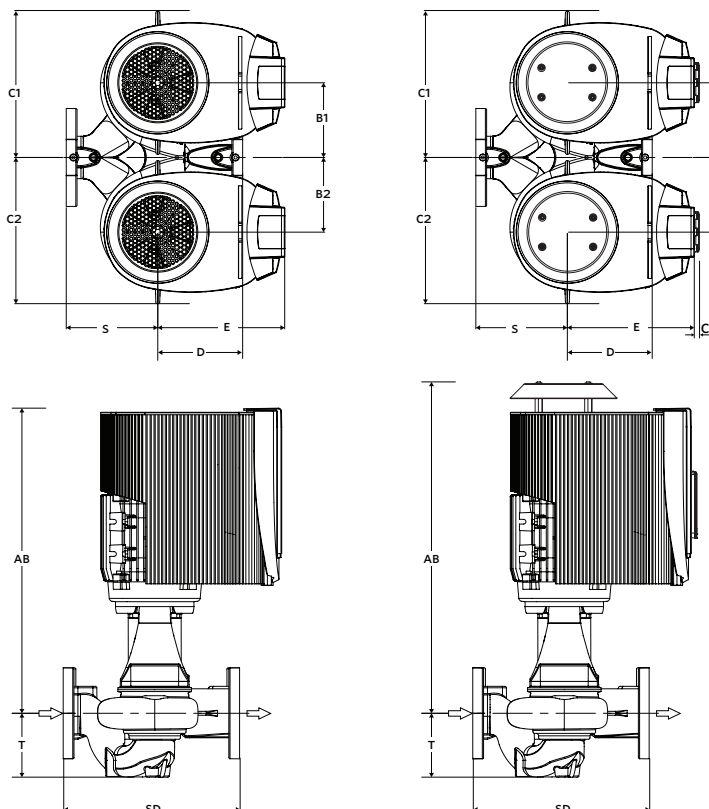

**TORONTO**

23 BERTRAND AVENUE  
TORONTO, ONTARIO  
CANADA, M1L 2P3  
+1 416 755 2291

**BUFFALO**

93 EAST AVENUE  
NORTH TONAWANDA, NEW YORK  
U.S.A., 14120-6594  
+1 716 693 8813

**DROITWICH SPA**

POINTON WAY,  
STONEBRIDGE CROSS BUSINESS PARK  
DROITWICH SPA, WORCESTERSHIRE  
UNITED KINGDOM, WR9 0LW  
+44 8444 145 145

**MANCHESTER**

WOLVERTON STREET  
MANCHESTER  
UNITED KINGDOM, M11 2ET  
+44 8444 145 145

**BANGALORE**

#59, FIRST FLOOR, 3RD MAIN  
MARGOSA ROAD, MALLESWARAM  
BANGALORE, INDIA, 560 003  
+91 80 4906 3555

**SHANGHAI**

UNIT 903, 888 NORTH SICHUAN RD.  
HONGKOU DISTRICT, SHANGHAI  
CHINA, 200085  
+86 21 5237 0909

**SÃO PAULO**

RUA JOSÉ SEMIÃO RODRIGUES AGOSTINHO,  
1370 GALPÃO 6 EMBU DAS ARTES  
SAO PAULO, BRAZIL  
+55 11 4785 1330

**LYON**

93 RUE DE LA VILLETTE  
LYON, 69003 FRANCE  
+33 4 26 83 78 74

**DUBAI**

JAFZA VIEW 19, OFFICE 402  
P.O.BOX 18226 JAFZA,  
DUBAI - UNITED ARAB EMIRATES  
+971 4 887 6775

**MANNHEIM**

DYNAMOSTRASSE 13  
68165 MANNHEIM  
GERMANY  
+49 621 3999 9858

**JIMBOLIA**

STR CALEA MOTILOR NR. 2C  
JIMBOLIA 305400, JUD.TIMIS  
ROMANIA  
+40 256 360 030

ARMSTRONG FLUID TECHNOLOGY  
ESTABLISHED 1934

ARMSTRONGFLUIDTECHNOLOGY.COM