

DESIGN ENVELOPE 4372 TANGO |

40-80 (1.5x1.5x3) | 4080-00.75 | SUBMITTAL

File No: 102.51901EC
 Date: NOVEMBER 08, 2021
 Supersedes: NEW
 Date: NEW

Job: _____ Representative: _____
 _____ Order No: _____ Date: _____
 Engineer: _____ Submitted by: _____ Date: _____
 Contractor: _____ Approved by: _____ Date: _____

PUMP DESIGN DATA

No. of pumps: _____ Tag: _____
 Total system design flow: _____ L/s (USgpm)
 Head: _____ m (ft) Capacity split _____ %
 Flow per pump head: _____ L/s (USgpm)
 Parallel flow: _____ L/s (USgpm)
 Liquid: _____ Viscosity: _____
 Temperature: _____ °C (°F) Specific gravity: _____
 Suction: 40 mm (1.5") Discharge: 40 mm (1.5")
 MEI ≥ 0.70

MATERIALS OF CONSTRUCTION

- PN 16**
 CONSTRUCTION: LPDESF
 E-coated ductile iron A536 Gr 65-45-12, stainless fitted
- PN 25**
 CONSTRUCTION: HPDESF
 E-coated ductile iron A536 Gr 120-90-2, stainless fitted

MAXIMUM PUMP OPERATING CONDITIONS

- PN 16**
 16 bars at 49°C (232 psig at 120°F)
 7 bars at 150°C (100 psig at 300°F)
- PN 25**
 25 bars at 65°C (362 psig at 149°F)
 21 bars at 150°C (304 psig at 300°F)

FLOW READOUT ACCURACY

The Design Envelope model selected will provide flow reading on the controls local keypad & digitally for the BMS. The model readout will be factory tested to ensure ±5% accuracy.

MECHANICAL SEAL DESIGN DATA

Seal type: 2A Stationary seat: Silicone carbide Secondary seal: EPDM Spring: Stainless steel Rotating hardware: Stainless steel

FLUID TYPE	ALL GLYCOLS > 30% WT CONC		ALL OTHER NON-POTABLE FLUIDS		POTABLE (DRINKING) WATER	
Temperature	up to 93°C / 200°F	over 93°C / 200°F	up to 93°C / 200°F	over 93°C / 200°F	up to 93°C / 200°F	over 93°C / 200°F
Rotating face	Silicone carbide		Resin bonded carbon	Antimony loaded carbon	Resin bonded carbon	
Seat elastomer	EPDM (L-cup)	EPDM (O-ring)	EPDM (L-cup)	EPDM (O-ring)	EPDM (L-cup)	EPDM (O-ring)
Material code	SCSc L EPSS 2A	SCSc O EPSS 2A	C-sc L EPSS 2A	ACSc O EPSS 2A	C-sc L EPSS 2A	C-sc O EPSS 2A

DEPM MOTOR AND CONTROL DATA

kW: 0.75
RPM: 3600
Motor enclosure: TEFC
Volts /Phase: 200-240V/1ph 380-480V/3ph
 For 200-240V/3ph or 575V/3ph, see File #: 102.51011EC
Efficiency: IE5
Orientation: Standard
Protocol (standard): BACnet™ MS/TP BACnet™ TCP/IP Modbus RTU
Control enclosure: Indoor - IP 55 Outdoor - IP 66
Fused disconnect switch: See File 100.8131
EMI/RFI control: Integrated filter designed to meet EN61800-3
Harmonic suppression: Equivalent: 5% AC line reactor - Supporting IEEE 519-1992 requirements**
Cooling: Fan-cooled, surface cooling
Ambient temperature: -10°C to +40°C up to 1000 meters above sea level (+14°F to +104°F, 3300 ft)
Analog I/O: Two inputs, one output. Output can be configured for voltage or current
Digital I/O: Two inputs, two outputs. Outputs can be configured as inputs
Relay outputs: Two programmable
Communication port: 1-RS485

** If supplied with the system electrical details, Armstrong will run a computer simulation of the system wide harmonics. If system harmonic levels are exceeded Armstrong can also recommend additional harmonic mitigation and the costs for such mitigation.

OPTIONS

SENSORLESS BUNDLE (STANDARD)



Operation of pump without a remote sensor. Includes:

- Sensorless control
- Flow readout
- Constant flow
- Constant pressure

Minimum system pressure to be maintained _____ m (ft)

* If minimum maintained system pressure is not known:
Default to 40% of design head

PARALLEL SENSORLESS



Operation of multiple pumps without a remote sensor

Minimum system pressure to be maintained _____ m (ft)

* If minimum maintained system pressure is not known:
Default to 40% of design head

ENERGY PERFORMANCE BUNDLE



Provides energy savings on oversized systems by adjusting pump parameters to on-site conditions. Includes:

- **Auto-flow balancing** - Automatically determines control curve between design flow at on-site system head, and minimum (zero-head) flow for energy savings
- **Maximum flow control** - Limits flow rate to pre-set maximum for potential energy savings

Maximum flow rate _____ L/s (gpm)

*Only available if sensorless bundle is enabled
*Available in single pump operation only

PROTECTION BUNDLE



Protects other flow sensitive equipment by setting limits of pump operation. Includes:

- **Minimum flow control** - Attempts to maintain flow rate to pre-set minimum to protect equipment in system
- **Bypass valve control** - Actuates a bypass valve to protect flow sensitive equipment if pre-set minimum flow rate is reached

Minimum flow rate _____ L/s (gpm)

*Only available if sensorless bundle is enabled

DUAL SEASON SETUP



Pre-sets heating and cooling parameters for pumps in 2-pipe systems

Cooling

Duty point _____ L/s (gpm) at _____ m (ft)

Minimum system pressure to be maintained _____ m (ft)

Heating

Duty point _____ L/s (gpm) at _____ m (ft)

Minimum system pressure to be maintained _____ m (ft)

*Available in single pump operation only

OPTIONAL SERVICES

ON-SITE PUMP COMMISSIONING



PUMP MANAGER



Online service for sustained pump performance and enhanced reliability.

Available in 3 or 5 year terms

* Requires an internet connection to be provided by building

* Includes an extended warranty for parts and labour (wearable parts excluded)

3

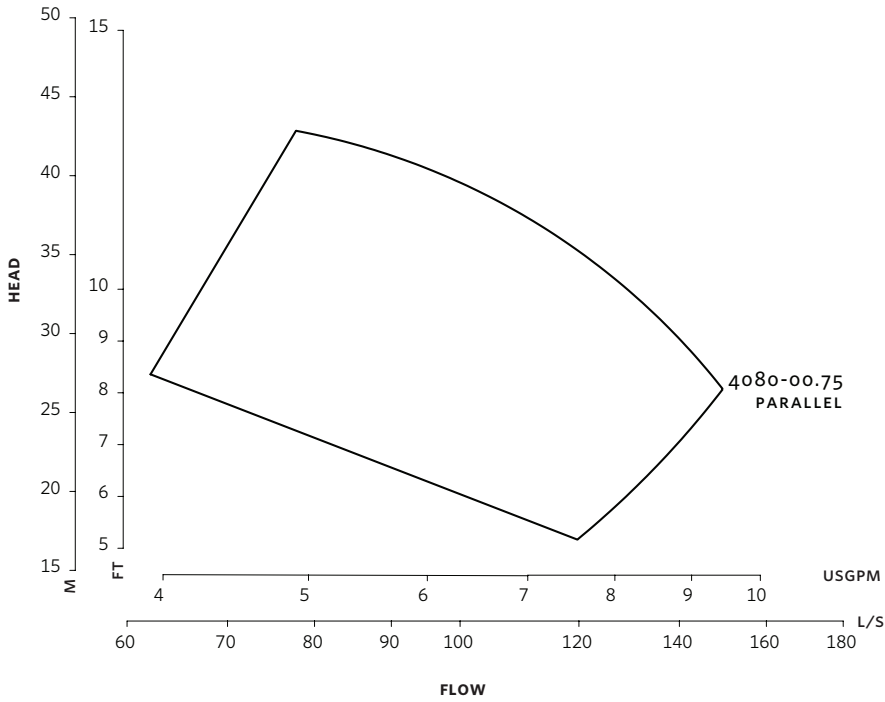

DIMENSION DATA

	INDOOR (IP55/TEFC)	OUTDOOR (IP66/TEFC)
Size:	40-80	40-80
kW:	0.75	0.75
RPM:	3600	3600
Frame:	71	71
AB:	340 (13.38)	369 (14.53)
B1:	124 (4.71)	124 (4.71)
B2:	124 (4.71)	124 (4.71)
C1:	254 (10.00)	254 (10.00)
C2:	254 (10.00)	254 (10.00)
CI:	-	70 (2.75)
D:	80 (3.15)	80 (3.15)
E:	152 (5.98)	163 (6.42)
S:	170 (6.69)	170 (6.69)
SD:	250 (9.84)	250 (9.84)
T:	71 (3.54)	71 (3.54)
Weight:	38.0 (83)	38.0 (83)

Performance curves are for reference only.
Confirm current performance data with Armstrong ADEPT Quote or ADEPT Select selection software.

Dimensions - mm (inch)
Weight - kg (lbs)

- Tolerance of ± 3 mm (± 0.125 ") should be used
- For exact installation, data please write factory for certified dimensions

INDOOR

OUTDOOR

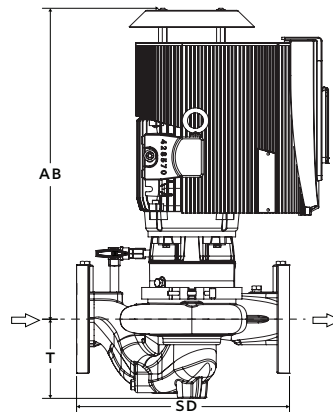
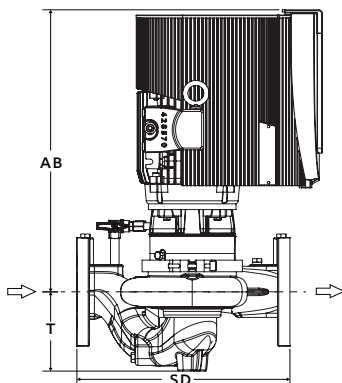
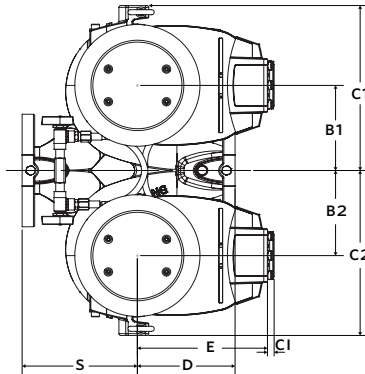
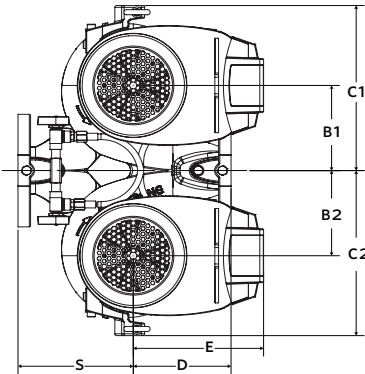

TORONTO

23 BERTRAND AVENUE
TORONTO, ONTARIO
CANADA, M1L 2P3
+1 416 755 2291

BUFFALO

93 EAST AVENUE
NORTH TONAWANDA, NEW YORK
U.S.A., 14120-6594
+1 716 693 8813

DROITWICH SPA

POINTON WAY,
STONEBRIDGE CROSS BUSINESS PARK
DROITWICH SPA, WORCESTERSHIRE
UNITED KINGDOM, WR9 0LW
+44 8444 145 145

MANCHESTER

WOLVERTON STREET
MANCHESTER
UNITED KINGDOM, M11 2ET
+44 8444 145 145

BANGALORE

#59, FIRST FLOOR, 3RD MAIN
MARGOSA ROAD, MALLESWARAM
BANGALORE, INDIA, 560 003
+91 80 4906 3555

SHANGHAI

UNIT 903, 888 NORTH SICHUAN RD.
HONGKOU DISTRICT, SHANGHAI
CHINA, 200085
+86 21 5237 0909

SÃO PAULO

RUA JOSÉ SEMIÃO RODRIGUES AGOSTINHO,
1370 GALPÃO 6 EMBU DAS ARTES
SAO PAULO, BRAZIL
+55 11 4785 1330

LYON

93 RUE DE LA VILLETTE
LYON, 69003 FRANCE
+33 4 26 83 78 74

DUBAI

JAFZA VIEW 19, OFFICE 402
P.O.BOX 18226 JAFZA,
DUBAI - UNITED ARAB EMIRATES
+971 4 887 6775

MANNHEIM

DYNAMOSTRASSE 13
68165 MANNHEIM
GERMANY
+49 621 3999 9858

JIMBOLIA

STR CALEA MOTILOR NR. 2C
JIMBOLIA 305400, JUD.TIMIS
ROMANIA
+40 256 360 030

ARMSTRONG FLUID TECHNOLOGY
ESTABLISHED 1934

ARMSTRONGFLUIDTECHNOLOGY.COM