

DESIGN ENVELOPE 4380 VIL

SINGLE PHASE | 0310-007.5 | SUBMITTAL

File No: 100.4397
 Date: OCTOBER 27, 2014
 Supersedes: NEW
 Date: NEW

Job: _____ Representative: _____
 _____ Order No: _____ Date: _____
 Engineer: _____ Submitted by: _____ Date: _____
 Contractor: _____ Approved by: _____ Date: _____

PUMP DESIGN DATA

No. of pumps: _____ Tag: _____
 Capacity: _____ USgpm (L/s) Head: _____ ft (m)
 Liquid: _____ Viscosity: _____
 Temperature: _____ °F (°C) Specific gravity: _____
 Suction: 3" (75mm) Discharge: 3" (75mm)

MOTOR DESIGN DATA

HP: 7.5 RPM: 1740 Frame size: _____
 Enclosure: _____ Volts: 208 Freq: 60 Hz
 Phase: 3 Efficiency: NEMA premium 12.12

MAXIMUM PUMP OPERATING CONDITIONS

ANSI 125

175 psig at 150°F (12 bars at 65°C)
 140 psig at 250°F (10 bars at 121°C)

ANSI 250

300 psig at 150°F (20 bars at 65°C)
 250 psig at 250°F (17 bars at 121°C)

- Tolerance of ±0.125" (±3 mm) should be used
- For exact installation, data please write factory for certified dimensions

MECHANICAL SEAL DATA

Seal type: 2A
 Stationary seat: Silicone carbide
 Secondary seal: EPDM
 Rotating hardware: Stainless steel
 Spring: Stainless steel

CONTROLS DATA

Power supply: Volts: 200-240VAC
 Freq: 50/60Hz Phase: 1

Sensorless control: Standard

Minimum system pressure to be maintained: _____ ft (m)*

Orientation: L1 (default) L2 L3 L4

Protocol (standard): Modbus RTU BACnet™ MS/TP
 Johnson® N2 Siemens® FLN

Protocol (optional): LonWorks®

Enclosure: Indoor - UL TYPE 12
 Outdoor - UL TYPE 4X with weather shield
 Outdoor - UL TYPE 4X less weather shield

Disconnect switch: Non-fused

EMI/RFI control: 1-phase IVS102 units do not meet the EN61800-3 directive

Harmonic suppression: Dual DC-link reactors (equivalent: 5% AC line reactor) supporting IEEE 519-1992 requirements**

Cooling: Fan-cooled through back channel

Ambient temperature: -10°C to +45°C up to 1000 meters above sea level (-14°F to +113°F, 3300 ft)

Analog i/o: Two current or voltage inputs, one current output

Digital i/o: Six programmable inputs (two can be configured as outputs)

Pulse inputs: Two programmable

Relay outputs: Two programmable

Communication port: 1-RS485, 1-USB

*If minimum maintained system pressure is not known: Default to 40% of design head
 **The IVS102 drive is a low harmonic drive via built-in DC line reactors. This does not guaranty performance to any system wide harmonic specification or the costs to meet a system wide specification. If supplied with the system electrical details, Armstrong will run a computer simulation of the system wide harmonics. If system harmonic levels are exceeded Armstrong can also recommend additional harmonic mitigation and the costs for such mitigation.

FLUID TYPE	ALL GLYCOLS > 30% WT CONC		ALL OTHER NON-POTABLE FLUIDS		POTABLE (DRINKING) WATER	
Temperature	up to 200°F / 93°C	over 200°F / 93°C	up to 200°F / 93°C	over 200°F / 93°C	up to 200°F / 93°C	over 200°F / 93°C
Rotating face	Silicone carbide		Resin bonded carbon	Antimony loaded carbon	Resin bonded carbon	
Seat elastomer	EPDM (L-cup)	EPDM (O-ring)	EPDM (L-cup)	EPDM (O-ring)	EPDM (L-cup)	EPDM (O-ring)
Material code	SCSc L EPSS 2A	SCSc O EPSS 2A	C-Sc L EPSS 2A	ACSc O EPSS 2A	C-Sc L EPSS 2A	C-Sc O EPSS 2A

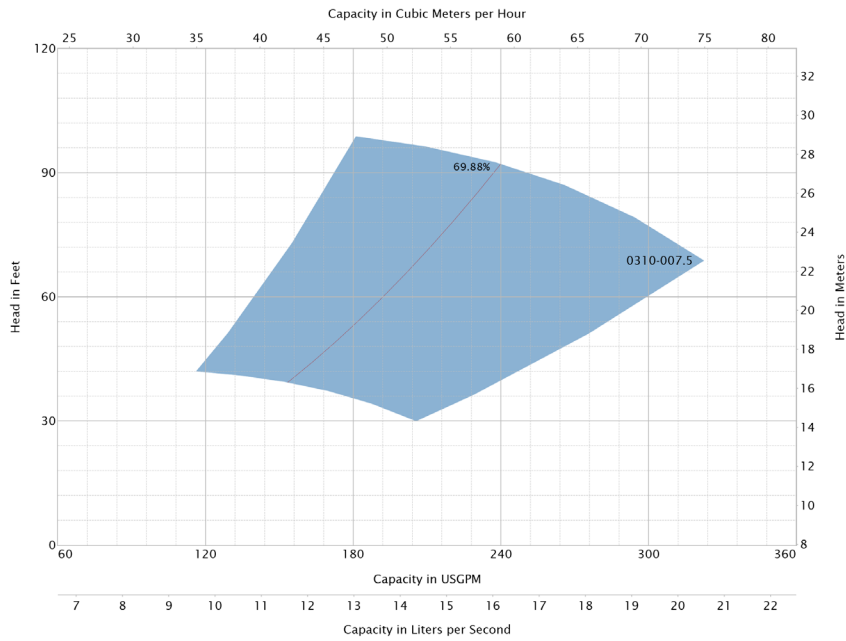

DIMENSION DATA

	INDOOR (UL TYPE 12/ODP)	OUTDOOR (UL TYPE 4X/TEFC)
Frame size:	213	213
Size:	3×3×10	3×3×10
HP:	7.5	7.5
RPM:	1740	1740
AB:	27.18(690)	33.22(844)
B:	7.16(182)	7.16(182)
C:	6.37(162)	6.37(162)
D:	9.50(241)	9.50(241)
E:	12.80(325)	15.92(404)
F:	16.44(418)	20.15(512)
P:	12.13(308)	11.25(286)
S:	11.50(292)	11.50(292)
SD:	21.00(533)	21.00(533)
T:	5.40(137)	5.40(137)
XY:	25.49(647)	26.61(676)
Weight:	406(184.2)	456(206.8)

Performance curves are for reference only.
Confirm current performance data with Armstrong ACE Online selection software.

Dimensions - inch (mm)
Weight - lbs (kg)

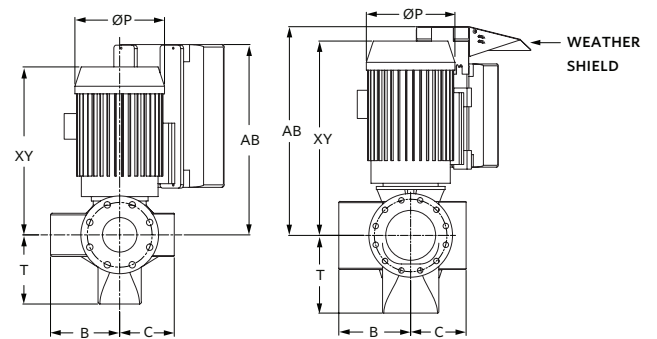
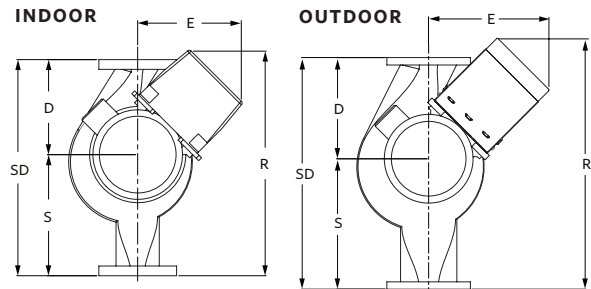
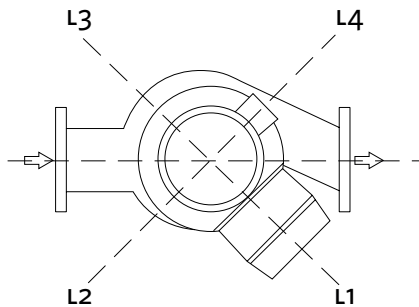

TORONTO
+416 755 2291

BUFFALO
+716 693 8813

BIRMINGHAM
+44 (0) 8444 145 145

MANCHESTER
+44 (0) 8444 145 145

BANGALORE
+91 (0) 80 4906 3555

SHANGHAI
+86 21 3756 6696