

DESIGN ENVELOPE DEPM IVS 4380 VIL | 0307-020.0 | SUBMITTAL

File No: 101.5770
Date: FEBRUARY 08, 2024
Supersedes: NEW
Date: NEW

Job: _____ Representative: _____
 _____ Order No: _____ Date: _____
 Engineer: _____ Submitted by: _____ Date: _____
 Contractor: _____ Approved by: _____ Date: _____

PUMP DESIGN DATA

No. of pumps: _____ Tag: _____
 Capacity: _____ USgpm (L/s) Head: _____ ft (m)
 Liquid: _____ Viscosity: _____
 Temperature: _____ °F (°C) Specific gravity: _____
 Suction: 3" (75mm) Discharge: 3" (75mm)

UL STD 778 & CSA STD C22.2 NO.108 certified

Test report is supplied with each pump

MATERIALS OF CONSTRUCTION

- ANSI 125**
CONSTRUCTION: SF
 E-coated cast iron, 316 stainless steel fitted
 Upgrade impeller to duplex stainless steel fitted (DF)
- ANSI 250**
CONSTRUCTION: DSF
 E-coated ductile iron, 316 stainless steel fitted
 Upgrade impeller to duplex stainless steel fitted (DDF)

MAXIMUM PUMP OPERATING CONDITIONS

- ANSI 125**
 175 psig at 150°F (12 bar at 65°C)
 140 psig at 250°F (10 bar at 121°C)
- ANSI 250**
 300 psig at 150°F (20 bar at 65°C)
 250 psig at 250°F (17 bar at 121°C)

MECHANICAL SEAL DESIGN DATA

Seal type: 2A **Stationary seat:** Silicone carbide
Secondary seal: EPDM **Spring:** Stainless steel
Rotating hardware: Stainless steel

DEPMH MOTOR AND CONTROLS DATA

HP: 20
Motor enclosure: TEFC
Volts: _____
Phase: 3
Efficiency: IE5
Orientation: L2 (default) L4
Protocol (standard): BACnet™ MS/TP BACnet™ TCP/IP
 Modbus RTU
Enclosure: Indoor - UL TYPE 12
 Outdoor - UL TYPE 4X with Weather Shield
Touchscreen cover: Option for Indoor units
Fused disconnect switch:
EMI/RFI control: Integrated filter designed to meet EN61800-3
Harmonic suppression: Dual DC-link reactors (Equivalent: 5% AC line reactor) Supporting IEEE 519-1992 requirements**
Cooling: Fan-cooled through back channel
Ambient temperature: -10°C to +45°C up to 1000 meters above sea level (+14°F to +113°F, 3300 ft)
Analog I/O: Two current or voltage inputs, one speed output
Digital I/O: Two inputs, two outputs
Pulse inputs: Two programmable
Relay outputs: Two programmable
Communication port: 1-RS485

**The IVS drive is a low harmonic drive via built-in DC line reactors. This does not guaranty performance to any system wide harmonic specification or the costs to meet a system wide specification. If supplied with the system electrical details, Armstrong will run a computer simulation of the system wide harmonics. If system harmonic levels are exceeded Armstrong can also recommend additional harmonic mitigation and the costs for such mitigation.

FLOW READOUT ACCURACY

The Design Envelope model selected will provide flow reading on the controls local keypad & digitally for the BMS and Pump Manager. The model readout will be factory tested to ensure ±5% accuracy.

FLUID TYPE	ALL GLYCOLS > 30% WT CONC		ALL OTHER NON-POTABLE FLUIDS		POTABLE (DRINKING) WATER	
Temperature	up to 200°F / 93°C	over 200°F / 93°C	up to 200°F / 93°C	over 200°F / 93°C	up to 200°F / 93°C	over 200°F / 93°C
Rotating face	Silicone carbide		Resin bonded carbon	Antimony loaded carbon	Resin bonded carbon	
Seat elastomer	EPDM (L-cup)	EPDM (O-ring)	EPDM (L-cup)	EPDM (O-ring)	EPDM (L-cup)	EPDM (O-ring)
Material code	SCSc L EPSS 2A	SCSc O EPSS 2A	C-SC L EPSS 2A	ACSc O EPSS 2A	C-SC L EPSS 2A	C-SC O EPSS 2A

OPTIONS

SENSORLESS BUNDLE (STANDARD)



Operation of pump without a remote sensor. Includes:

- Sensorless control
- Flow readout
- Constant flow
- Constant pressure

Minimum system pressure to be maintained _____ ft (m)

* If minimum maintained system pressure is not known: Default to 40% of design head

□ PARALLEL SENSORLESS



Operation of multiple pumps without a remote sensor

Minimum system pressure to be maintained _____ ft (m)

* If minimum maintained system pressure is not known: Default to 40% of design head

□ ENERGY PERFORMANCE BUNDLE



Provides energy savings on oversized systems by adjusting pump parameters to on-site conditions. Includes:

- **Auto-flow balancing** – Automatically determines control curve between design flow at on-site system head, and minimum (zero-head) flow for energy savings
- **Maximum flow control** – Limits flow rate to pre-set maximum for potential energy savings

Maximum flow rate _____ gpm (L/s)

*Only available if sensorless bundle is enabled

□ PROTECTION BUNDLE



Protects other flow sensitive equipment by setting limits of pump operation. Includes:

- **Minimum flow control** – Attempts to maintain flow rate to pre-set minimum to protect equipment in system
- **Bypass valve control** – Actuates a bypass valve to protect flow sensitive equipment if pre-set minimum flow rate is reached

Minimum flow rate _____ gpm (L/s)

*Only available if sensorless bundle is enabled

□ ZONE OPTIMIZATION BUNDLE



Controls pumps to ensure multiple zones are satisfied for heating or cooling

- **2 sensor control** – Controls pumps in a 2-zone application to ensure both zones are always satisfied for heating or cooling

□ DUAL SEASON SETUP



Pre-sets heating and cooling parameters for pumps in 2-pipe systems

Cooling

Duty point _____ gpm (L/s) at _____ ft (m)

Minimum system pressure to be maintained _____ ft (m)

Heating

Duty point _____ gpm (L/s) at _____ ft (m)

Minimum system pressure to be maintained _____ ft (m)

OPTIONAL SERVICES

ON-SITE PUMP COMMISSIONING



When purchased and applicable, onsite commissioning by an Armstrong representative will include setting up communication with the Pump (not wiring to BAS), adjusting parameters to match on-site conditions, register the pumps for enhanced warranty and connect the pumps to the router as part of the activation of Pump Manager.

PUMP MANAGER



As a Performance Management Service, Pump Manager is an online automated fault detection and diagnostic service for sustained performance and enhanced reliability. It includes advanced trending, alerts of variance in performance and automated reports.

Available in yearly increments. Includes an option for a price discount on the Extended Warranty Service.

*The Service requires an active internet connection.

PERFORMANCE CURVES

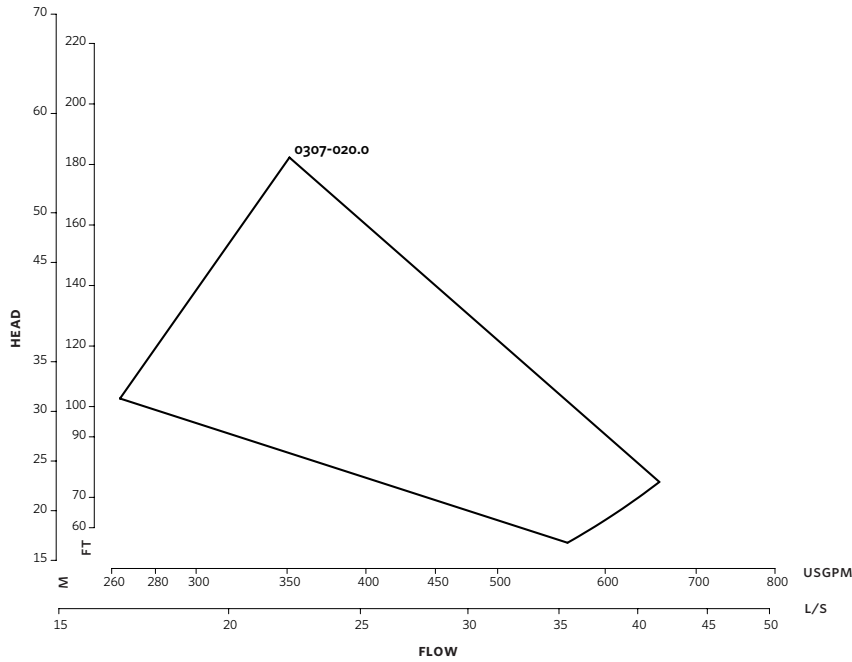

Performance curves are for reference only.
Confirm current performance data with Armstrong ADEPT Quote or ADEPT Select selection software.

DIMENSION DATA

	INDOOR (UL TYPE 12/TEFC)	OUTDOOR (UL TYPE 4X/TEFC)
Size:	3×3×7.5	3×3×7.5
HP:	20	20
AB:	38.00 (965)	41.00 (1041)
D:	10.00 (254)	10.00 (254)
E:	17.87 (454)	17.87 (454)
F:	30.00 (762)	30.00 (762)
P:	11.42 (290)	11.42 (290)
S:	12.00 (305)	12.00 (305)
SD:	22.00 (559)	22.00 (559)
T:	6.70 (170)	6.70 (170)
XY:	39.00 (991)	39.00 (991)
Weight:	479 (217.0)	482 (218.4)

Dimensions - inch (mm)
Weight - lbs (kg)

- Tolerance of ±0.125" (±3 mm) should be used
- For exact installation, data please write factory for certified dimensions

INDOOR

OUTDOOR

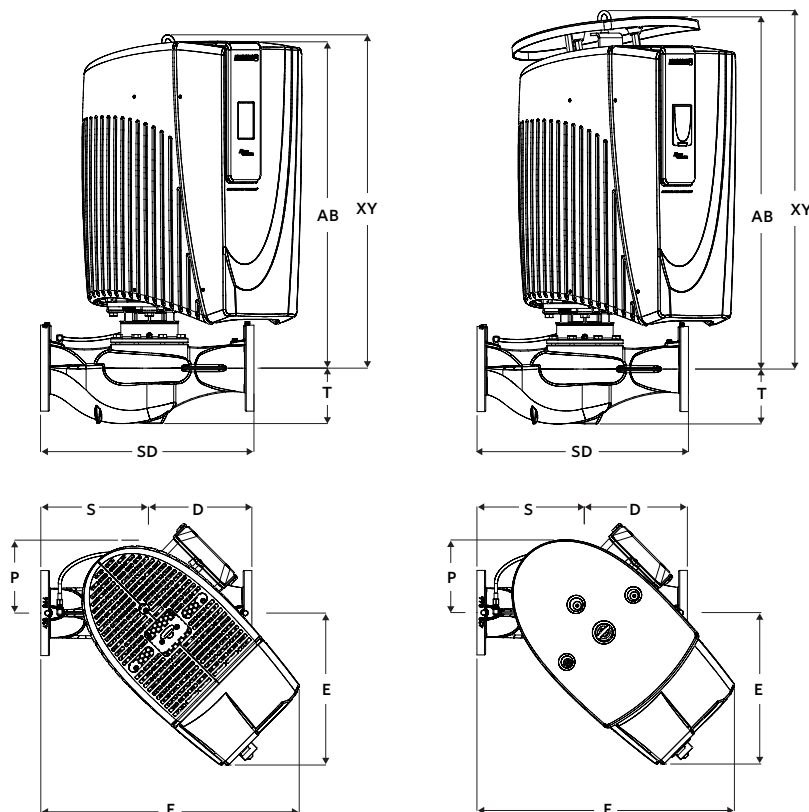

CONTROL ORIENTATIONS

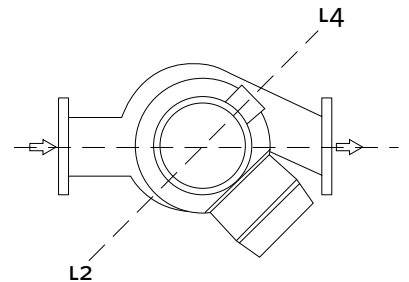

TORONTO

23 BERTRAND AVENUE,
TORONTO, ONTARIO,
CANADA, M1L 2P3
+1 416 755 2291

BUFFALO

93 EAST AVENUE, NORTH
TONAWANDA, NEW YORK,
USA, 14120-6594
+1 716 693 8813

DROITWICH SPA

POINTON WAY, STONEBRIDGE CROSS
BUSINESS PARK, DROITWICH SPA,
WORCESTERSHIRE,
UNITED KINGDOM, WR9 0LW
+44 121 550 5333

MANCHESTER

WOLVERTON STREET, MANCHESTER
UNITED KINGDOM, M11 2ET
+44 161 223 2223

BANGALORE

#18, LEWIS WORKSPACE, 3RD FLOOR,
OFF MILLERS - NANDIDURGA ROAD,
JAYAMAHAL CBD, BENSON TOWN,
BANGALORE, INDIA 560 046
+91 80 4906 3555

SHANGHAI

UNIT 903, 888 NORTH SICHUAN RD.
HONGKOU DISTRICT, SHANGHAI
CHINA, 200085
+86 21 5237 0909

BEIJING

ROOM 1612, NANYIN BUILDING NO.2
NORTH EAST THRID RING ROAD
CHAOYANG DISTRICT, BEIJING,
CHINA 100027
+86 21 5237 0909

SÃO PAULO

RUA JOSÉ SEMIÃO RODRIGUES
AGOSTINHO, 1370 GALPÃO 6 EMBU
DAS ARTES, SAO PAULO, BRAZIL
+55 11 4785 1330

LYON

93 RUE DE LA VILLETTE
LYON, 69003 FRANCE
+33 4 26 83 78 74

DUBAI

JAFZA VIEW 19, OFFICE 402
P.O. BOX 18226 JAFZA,
DUBAI - UNITED ARAB EMIRATES
+971 4 887 6775

JIMBOLIA

STR CALEA MOTILOR NR. 2C
JIMBOLIA 305400, JUD.TIMIS
ROMANIA
+40 256 360 030

FRANKFURT

WESTERBACHSTRASSE 32,
D-61476 KRONBERG IM TAUNUS
GERMANY
+49 6173 999 77 55

ARMSTRONG FLUID TECHNOLOGY®
ESTABLISHED 1934

ARMSTRONGFLUIDTECHNOLOGY.COM