

DESIGN ENVELOPE 4382 DUALARM | 0808-005.0 | SUBMITTAL

File No: 100.4652
 Date: OCTOBER 30, 2015
 Supersedes: NEW
 Date: NEW

Job: _____ Representative: _____

Order No: _____ Date: _____

Engineer: _____ Submitted by: _____ Date: _____

Contractor: _____ Approved by: _____ Date: _____

PUMP DESIGN DATA

No. of pumps: _____ Tag: _____
 Capacity: _____ USgpm (L/s) Head: _____ ft (m)
 Liquid: _____ Viscosity: _____
 Temperature: _____ °F (°C) Specific gravity: _____
 Suction: 8" (200mm) Discharge: 8" (200mm)

OSHPD Seismic Certification OSP-0422-10
UL STD 778 & CSA STD C22.2 NO.108 certified

MOTOR DESIGN DATA

HP: _____ RPM: _____ Frame size: _____ Enclosure: _____
 Volts: _____ Hertz: 60 Hz Phase: 3
 Efficiency: NEMA premium 12.12

MAXIMUM PUMP OPERATING CONDITIONS

ANSI 125

175 psig at 150°F (12 bars at 65°C)
 140 psig at 250°F (10 bars at 121°C)

ANSI 250

250 psig at 150°F (17 bars at 65°C)
 250 psig at 250°F (17 bars at 121°C)

- Tolerance of ±0.125" (±3 mm) should be used
- For exact installation, data please write factory for certified dimensions

MECHANICAL SEAL DATA

Seal Type: 2A Stationary Seat: Silicon carbide
 Secondary Seal: EPDM Rotating Hardware: Stainless steel
 Spring: Stainless steel

CONTROLS DATA

Sensorless Control: Standard
Minimum system pressure to be maintained: _____ ft (m)*
Protocol (standard): Modbus RTU BACnet™ MS/TP
 Johnson® N2 Siemens® FLN
Protocol (optional): LonWorks®
Enclosure: Indoor - UL TYPE 12
 Outdoor - UL TYPE 4X with Weather Shield
 Outdoor - UL TYPE 4X less Weather Shield
Fused disconnect switch:
Duty/standby pre-wired bridge:
EMI/RFI control: Integrated filter designed to meet EN61800-3
Harmonic suppression: Dual dc-link reactors (Equivalent: 5% AC line reactor) Supporting IEEE 519-1992 requirements**
Cooling: Fan-cooled through back channel
Ambient temperature: -10°C to +45°C up to 1000 meters above sea level (-14°F to +113°F, 3300 ft)
Analog I/O: Two current or voltage inputs, one current output
Digital I/O: Six programmable inputs (two can be configured as outputs)
Pulse inputs: Two programmable
Relay outputs: Two programmable
Communication port: 1-RS485, 1-USB

*If minimum maintained system pressure is not known: Default to 40% of design head
 **The Ivs 102 drive is a low harmonic drive via built-in dc line reactors. This does not guaranty performance to any system wide harmonic specification or the costs to meet a system wide specification. If supplied with the system electrical details, Armstrong will run a computer simulation of the system wide harmonics. If system harmonic levels are exceeded Armstrong can also recommend additional harmonic mitigation and the costs for such mitigation.

FLUID TYPE	ALL GLYCOLS > 30% WT CONC		ALL OTHER NON-POTABLE FLUIDS		POTABLE (DRINKING) WATER	
Temperature	up to 200°F / 93°C	over 200°F / 93°C	up to 200°F / 93°C	over 200°F / 93°C	up to 200°F / 93°C	over 200°F / 93°C
Rotating Face	Silicon carbide		Resin bonded carbon	Antimony loaded carbon	Resin bonded carbon	
Seat Elastomer	EPDM (L-cup)	EPDM (O-ring)	EPDM (L-cup)	EPDM (O-ring)	EPDM (L-cup)	EPDM (O-ring)
Material Code	SCsc L EPSS 2A	SCsc O EPSS 2A	C-sc L EPSS 2A	ACsc O EPSS 2A	C-sc L EPSS 2A	C-sc O EPSS 2A

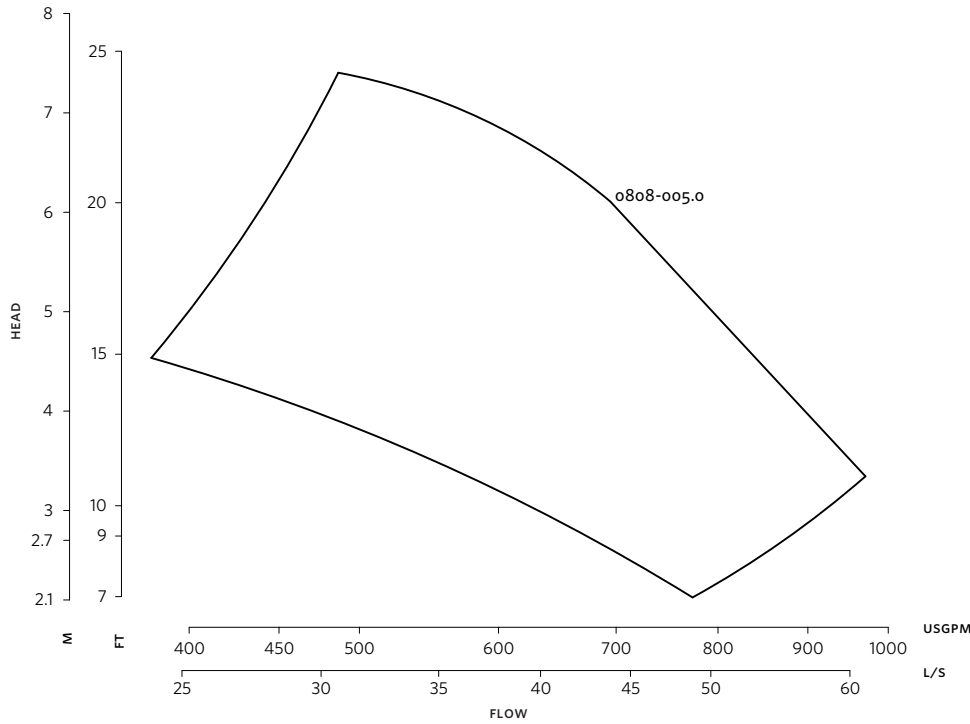

DIMENSION DATA

	INDOOR (UL TYPE 12/ODP)	OUTDOOR (UL TYPE 4X/TEFC)
Frame size:	213	213
Size:	8×8×8	8×8×8
HP:	5	5
RPM:	1500	1500
AB:	29.22(742)	29.22(742)
B1:	10.00(254)	10.00(254)
B2:	9.00(229)	9.00(229)
C1:	18.50(470)	18.50(470)
C2:	18.60(472)	18.60(472)
D1:	18.50(470)	18.50(470)
D2:	23.00(584)	23.00(584)
E:	8.25(210)	8.25(210)
F:	16.77(426)	16.77(426)
P:	11.25(286)	11.25(286)
SD:	45.50(1156)	45.50(1156)
T:	9.47(240)	9.47(240)
XY:	27.21(691)	27.21(691)
Weight:	1178(534.3)	1237(561.0)

Performance curves are for reference only.
Confirm current performance data with Armstrong ACE Online selection software.

Dimensions - inch (mm)
Weight - lbs (kg)

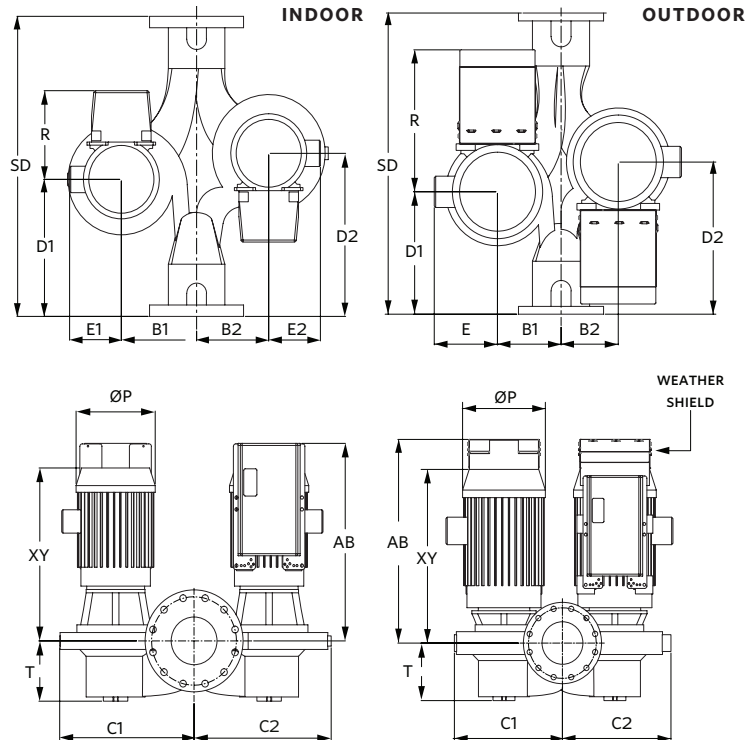

TORONTO
+1 416 755 2291

BUFFALO
+1 716 693 8813

BIRMINGHAM
+44 (0) 8444 145 145

MANCHESTER
+44 (0) 8444 145 145

BANGALORE
+91 (0) 80 4906 3555

SHANGHAI
+86 21 3756 6696