

Cross Reference

Manual

File No: 9.06

Date: NOVEMBER 2013

Supersedes: NEW

Date: NEW

—

—

—







—

CONTENTS







B&G to Armstrong	1
Circulator parts	37
Flanges (circulators)	77
Base mounted pump parts	81
Motor mounted pump parts	105
VIL centrifugal pumps	123
Shell & Tube heat exchangers	127









B&G TO ARMSTRONG CROSS REFERENCE

New B&G numbers sorted numerically:









NEW B&G	OLD B&G	ARMSTRONG	DESCRIPTION	UPC CODE
A24600	AC3-1227	833615-010	FLANGE PD39 CAST IRON	 6 72807 28750 4
111031	P4Z-4	817025-001	1/6 HP POWER PACK - 1PH 115V	 6 72807 28628 6
111034	P-115Z-3	805316-010	1/12 HP POWER PACK - 1PH 115V	 6 72807 28124 3
111036	P115Z-4	817025-001	1/6 HP POWER PACK - 1PH 115V	 6 72807 28628 6
111040	P115Z-10	817025-007	3/4 HP POWER PACK - 1PH 115V	 6 72807 28630 9
111044	PDH1530Z-14	811757-001	1/2 HP POWER PACK 1PH/60/115/230	 6 72807 28380 3
111046	PWH-931-6Z-1296	811757-020	1/2 HP POWER PACK 3PH/60/208/230/460	
111047	PDH1530Z-16	811757-002	3/4 HP POWER PACK 1PH/60/115/230	 6 72807 28381 0
111049	P922-6PDZ-1296	811757-024	3/4 HP POWER PACK 3PH/60/208/230/460	





2

NEW B&G	OLD B&G	ARMSTRONG	DESCRIPTION	UPC CODE
111050	PDH1530Z-18	811757-007	1 HP POWER PACK 1PH/60/115/230	 6 72807 28384 1
111051	PD2628Z-1296	811757-028	1 HP POWER PACK 3PH/60/208/230/460	
111052	PWH-2641Z-1296	816678-069	1 ½ HP POWER PACK 3PH/60/208/230/460	 6 72807 28598 2
111061		817025-005	1/6 HP POWER PACK (B&G PUMPS ONLY)	 6 72807 28629 3
118065	F-818	805209-000	FLANGE GASKET 2"	 6 72807 28123 6
118066	F-827	806074-011	FLANGE 60-14, 60-18 TO 60-21 CAST IRON	
118097	FB-827	806074-041	FLANGE 60-14, 60-18 TO 60-21 BRONZE	
118129	G86500	805201-000	FLANGE GASKET 2 ½, LD3, HD3, PD35, 37, 39	 6 72807 28122 9
118339	P00350	805482-011	C.I. BODY 75-150	 6 72807 28126 7
118347	P2-327ST	816013-041	FLANGE #75 BRONZE	







NEW B&G	OLD B&G	ARMSTRONG	DESCRIPTION	UPC CODE
118356	P8-427CB	816012-041	FLANGE #100 BRONZE	
118368	P-518	805176-000	FLANGE GASKET 1PR, 60-11, 60-12, 60-13	 6 72807 28116 8
118373	P-618	804034-000	FLANGE GASKET 1 1/2, HV, 60-15 TO 60-17	 6 72807 28103 8
118378	P-818	816117-000	FLANGE GASKET 60-14, 60-18 TO 60-21	 6 72807 28445 9
118413	P06440	805482-041	BRONZE BODY 75-150	 6 72807 28127 4
118431	P07680	812961-041	BRONZE IMPELLER 75-150	 6 72807 28404 6
118435		806331-111	NORYL IMPELLER 1 1/2"	 6 72807 28155 7
118436		816556-041	BRONZE IMPELLER 2", HV	 6 72807 28569 2
118440	P07900	816305-058	BRONZE IMPELLER 2 1/2", LD3	 6 72807 28503 6
118447	PB4Z-12351	816027-002	SEAL BRG. ASSY. (A.B.)	 6 72807 28433 6





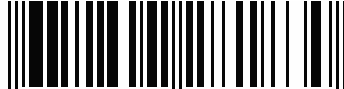
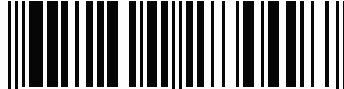





4

NEW B&G	OLD B&G	ARMSTRONG	DESCRIPTION	UPC CODE
118449	P08420	804133-011	C.I. BODY PD35-PD37	 6 72807 28104 5
118452 (CI)		816311-041	BRONZE IMPELLER, 6", FITS PD-38, 39, 40	 6 72807 28511 1
118453 (BR)		816311-041	BRONZE IMPELLER, 6", FITS PD-38, 39, 40	 6 72807 28511 1
118473	PDZ-12291	807436-000	COUPLER 60-1 60-2 (OLD) 60-11 (NEW)	 6 72807 28170 0
118476	PD27-12291	816665-000	COUPLER 5/8" x 5/8"	 6 72807 28594 4
118612	P40490	816301-055	BRONZE IMPELLER 1" PR	 6 72807 28455 8
118626	P56810	816304-047	BRONZE IMPELLER 60-14	 6 72807 28487 9
118627	P56830	816304-051	BRONZE IMPELLER PD35	 6 72807 28488 6
118629		816304-027	STEEL IMPELLER 60-14	 6 72807 28486 2
118630	P61570	816304-021	STEEL IMPELLER PD35	 6 72807 28485 5









NEW B&G	OLD B&G	ARMSTRONG	DESCRIPTION	UPC CODE
118637	P63760	811240-011	C.I. BODY 1" PR	 6 72807 28373 5
118641		816402-011	C.I. BODY 1 1/2", HV	 6 72807 28560 9
118642		816402-041	BRZ. BODY 1 1/2", HV	 6 72807 28561 6
118644	P2Z-121	805484-011	C.I. BODY S45, S46	 6 72807 28128 1
118666		806331-111	NORYL IMPELLER 1 1/2"	 6 72807 28155 7
118668		816556-011	STEEL IMPELLER 2", HV	 6 72807 28568 5
118676	P65290	816305-028	STEEL IMPELLER 2 1/2", LD3	 6 72807 28501 2
118681		816706-021	SEAL KIT 75 TO PD37, HV TO 60-14	 6 72807 28602 6
118705	PZ-4291	806026-001	COUPLER 75-150, 1 1/2, 2, HV, PR	 6 72807 28131 1
118708	P2Z-491	806140-000	COUPLER 1/2" x 3/4" PD35-PD37	 6 72807 28145 8

6

NEW B&G	OLD B&G	ARMSTRONG	DESCRIPTION	UPC CODE
118709	P4Z-4291	806137-000	COUPLER PD35-PD37	 6 72807 28143 4
118723	P2Z-12291	806168-001	COUPLER 2 1/2, LD3, HD3	 6 72807 28148 9
118830	PRZ-435	816301-025	STEEL IMPELLER 1 PR	 6 72807 28454 1
118840	P3500S-0311Z	812961-011	STEEL IMPELLER 75-150	 6 72807 28403 9
118844	PZ OR PAZ-3351	810119-001	SEAL BRG. ASSY. (STD./B.F.)	 6 72807 28183 0
169005		816678-062	1 1/2 HP POWER PACK 1PH/60/115/230	 6 72807 28597 5
169038	PDH1530Z	816141-002	1/3 HP POWER PACK 1PH/60/115/230	 6 72807 28449 7
169091	PDH82040Z-20	816678-069	1 1/2 HP POWER PACK 3PH/60/208/230/460	 6 72807 28598 2
169092		816678-069	1 1/2 HP POWER PACK 3PH/60/208/230/460	 6 72807 28598 2
185011	977075	819359-002	BEARING FRAME ASSEMBLY B.F. - A.I.	 6 72807 28656 9









NEW B&G	OLD B&G	ARMSTRONG	DESCRIPTION	UPC CODE
185012	P77222	819359-002	BEARING FRAME ASSEMBLY B.F. - A.I.	 6 72807 28656 9
185013	P77226	819360-002	BEARING FRAME ASSEMBLY A.B.	 6 72807 28657 6
185014	P77074	819310-071	BEARING FRAME ASSEMBLY A.B. - B.F - A.I.	 6 72807 28638 5
185015	P77229	819310-071	BEARING FRAME ASSEMBLY A.B. - B.F - A.I.	 6 72807 28638 5
185016	P77228	819310-071	BEARING FRAME ASSEMBLY A.B. - B.F - A.I.	 6 72807 28638 5
185021	PW-2438AB	810150-152	SHAFT SLEEVE 1 5/8" B.F. - A.B.	 6 72807 28367 4
185022	PW-2438SS	810150-153	SHAFT SLEEVE 1 5/8" A.I.	 6 72807 28368 1
185024	PW1-538AB	835085-001	SHAFT SLEEVE 1 1/4" B.F. - A.B.	 6 72807 28753 5
185025	PW4-538SS	835085-002	SHAFT SLEEVE 1 1/4" A.I.	 6 72807 28754 2
185232	PD26Z-12351	816133-000	SEAL BRG. ASSY. (STD./B.F.)	 6 72807 28446 6











8









NEW B&G	OLD B&G	ARMSTRONG	DESCRIPTION	UPC CODE
185234	PD27Z-12351	816134-000	SEAL BRG. ASSY. (A.B.)	 6 72807 28447 3
185260		816133-000	SEAL BRG. ASSY. (STD./B.F.)	 6 72807 28446 6
185262		816134-000	SEAL BRG. ASSY. (A.B.)	 6 72807 28447 3
186359	PWB13Z-335	816302-049	BRONZE IMPELLER 60-2, 60-11	 6 72807 28463 3
186360	PWB13Z-335	816302-049	BRONZE IMPELLER 60-11	 6 72807 28463 3
186368	P61010	816303-047	BRONZE IMPELLER 60-13	 6 72807 28476 3
186384	PWH-41	816337-011	C.I. BODY 60-1 (OLD) 60-11 (NEW)	 6 72807 28518 0
186385	PWHB-41	816337-041	BRONZE BODY 60-1 (OLD) 60-11 (NEW)	 6 72807 28519 7
186386	PWH-41	816337-011	C.I. BODY 60-2 (OLD)	 6 72807 28518 0
186392	PWH-81	816338-011	C.I. BODY 60-4 (OLD) 60-14 (NEW)	 6 72807 28520 3



NEW B&G	OLD B&G	ARMSTRONG	DESCRIPTION	UPC CODE
186410	PWHZ-6291	812734-000	COUPLER 1/2" x 5/8" FLEX 60-15 TO 60-21	6 72807 28399 5
186441	PW13Z-335	816302-019	STEEL IMPELLER 60-2	6 72807 28458 9
186482	PW4Z-544	409564-011	COVERPLATE 1 3/4A TO 4AB C.I.	6 72807 04822 8
186495	PW6Z-1044	409563-011	COVERPLATE 1 3/4BB TO 5BB C.I.	6 72807 04812 9
186499		810120-009	3/4" MECHANICAL SEAL KIT	6 72807 28198 4
186526	PWz-5282	409026-012	M/P BRKT. 1 3/4AB-4AB B.F. - A.I.	6 72807 04802 0
186528	PW2Z-5282	406931-012	M/P BRKT. 1 3/4AB-4AB B.F. - A.I.	6 72807 04763 4
186530	PW4Z-5282	406948-012	M/P BRKT. 1 3/4BB-5BB B.F. - A.I.	6 72807 04778 8
186533	PW8Z-5282	409023-012	M/P BRKT. 1 3/4BB-5BB B.F. - A.I.	6 72807 04798 6
186543		811339-000	#8 MECHANICAL SEAL KIT	6 72807 28376 6

10



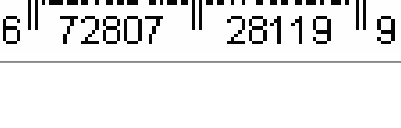



NEW B&G	OLD B&G	ARMSTRONG	DESCRIPTION	UPC CODE
186544		811866-000	#9 MECHANICAL SEAL KIT	 6 72807 28395 7
186681		816706-021	½" MECHANICAL SEAL KIT A.I.	 6 72807 28602 6
186860		825458-001	#4 MECHANICAL SEAL KIT	 6 72807 28676 7
186862		825458-001	#1 MECHANICAL SEAL KIT	 6 72807 28676 7
186863	PD2Z-12351	816032-000	SEAL BRG. ASSY. (STD./B.F.)	 6 72807 28437 4
186864	PD6Z-12351	816032-000	SEAL BRG. ASSY. (A.B.)	 6 72807 28437 4
186868	PW54Z-4291	819340-002	COUPLER 4J	 6 72807 28641 5
186869	PW55Z-4291	819341-002	COUPLER 4J	 6 72807 28642 2
186870	PW56Z-4291	819342-002	COUPLER 5J	 6 72807 28643 9
186871	PW58Z-4291	819344-002	COUPLER 6J	 6 72807 28645 3

NEW B&G	OLD B&G	ARMSTRONG	DESCRIPTION	UPC CODE
186872		819344-012	COUPLER 6J	 6 72807 28645 3
186873	PW59Z-4291	819347-002	COUPLER 7J	 6 72807 28647 7
189034	PB1Z-3351	810119-001	SEAL BRG. ASSY. (A.B.)	 6 72807 28183 0
189100	P7Z-4351	810119-003	SEAL BRG. ASSY. (STD./B.F.)	 6 72807 28184 7
189101	P8Z-4351	810119-003	SEAL BRG. ASSY. (STD./B.F.)	 6 72807 28184 7
189102	P15Z-4351	810119-003	SEAL BRG. ASSY. (STD./B.F.)	 6 72807 28184 7
189103	PB10Z-4351	810119-003	SEAL BRG. ASSY.(A.B.)	 6 72807 28184 7
189105	P3Z-12351	816027-002	SEAL BRG. ASSY.(STD./B.F.)	 6 72807 28433 6
189106	PB47-12351	816027-002	SEAL BRG. ASSY.. (A.B.)	 6 72807 28433 6
189110	P11Z-4291	806026-001	COUPLER ½" x ½" 75 TO 150, 1 ½, 2, HV, PR	 6 72807 28131 1

NEW B&G	OLD B&G	ARMSTRONG	DESCRIPTION	UPC CODE
189120		816023-001	SEAL BRG. ASSY. (STD./B.F.) B&G PUMPS ONLY	 6 72807 28432 9
189121		816023-001	SEAL BRG. ASSY. (STD./B.F.) B&G PUMPS ONLY	 6 72807 28432 9
189122		816023-001	SEAL BRG. ASSY. (STD./B.F.) B&G PUMPS ONLY	 6 72807 28432 9
189129		816023-001	SEAL BRG. ASSY. (STD./B.F.) B&G PUMPS ONLY	 6 72807 28432 9
189131		816023-001	SEAL BRG. ASSY. (A.B.) B&G PUMPS ONLY	 6 72807 28432 9
189132	P4Z-335	812961-111	NORYL IMPELLER 75-150	 6 72807 28405 3
F74000	FLG2-1227CI	805188-011	FLANGE Pd 35, Pd37, 3LD, 3HD CAST IRON	 6 72807 28118 2
F74800	FLG82-1227	805188-041	FLANGE PD35, PD37, 3LD, 3HD BRONZE	 6 72807 28119 9
PO0740	P2-327ST	816013-011	FLANGE #75 CAST IRON	
PO01500	P5-427	806073-011	FLANGE 1" HV CAST IRON	 6 72807 28137 3









NEW B&G	OLD B&G	ARMSTRONG	DESCRIPTION	UPC CODE
P01510	P7-427ST	816012-011	FLANGE #100 CAST IRON	
P03250	P1-525ST	816011-011	FLANGE #125 CAST IRON	
P03300	P5-527ST	804300-011	FLANGE 1 ¼" HV CAST IRON	 6 72807 28106 9
P03410	P2-627ST	804301-011	FLANGE 60-15 TO 60-17 CAST IRON	 6 72807 28110 6
P03410	P2-627ST	804301-011	FLANGE 1 ½ HV CAST IRON	 6 72807 28110 6
P03430	P3-627CI	816009-011	FLANGE 60-13 CAST IRON	
P03430	P3-627CI	816009-011	FLANGE #150 CAST IRON	
P03450	P3-627CB	816009-041	FLANGE 60-13 BRONZE	
P03450	P3-627CB	816009-041	FLANGE #150 BRONZE	
P03560	P1-1027CI	805189-011	FLANGE 2 ½" CAST IRON	



14

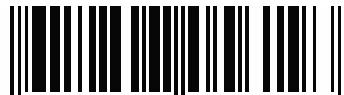









NEW B&G	OLD B&G	ARMSTRONG	DESCRIPTION	UPC CODE
P04080	P-3133	104442-000	BODY GASKET 75-150	 6 72807 01077 5
P04890	P-4133	106049-000	BODY GASKET 1 ½, 2, HV	 6 72807 01132 1
P05800	P1-12133	106050-000	BODY GASKET 2 ½, LD3, HD3, 1PR	 6 72807 01133 8
P06620	PB4-427CB	806073-041	FLANGE 1" HV BRONZE	 6 72807 28138 0
P06640	PB2-527	816011-041	FLANGE #125 BRONZE	
P06660	PB4-527	804300-041	FLANGE 1 ¼" HV BRONZE	 6 72807 28107 6
P06690	PB1-627CB	804301-041	FLANGE 60-15 TO 60-17 BRONZE	 6 72807 28111 3
P06690	PB1-627CB	804301-041	FLANGE 1 ½ HV BRONZE	
P06750	PB1-1027CB	805189-041	FLANGE 2 ½" BRONZE	
P07570	PB9Z-41	811240-041	BRONZE BODY 1'PR	 6 72807 28374 2

NEW B&G	OLD B&G	ARMSTRONG	DESCRIPTION	UPC CODE
P07610	PB2Z-121	805484-041	BRONZE BODY 2 ½, LD3, HD3	6 72807 28129 8
P09290	PDB1-121	804133-041	BRONZE BODY PD35-PD37	6 72807 28105 2
P14120	PW6-81CI	419153-011	VOLUTE U2B & 2BB CAST IRON	6 72807 05416 8
P14120	PW6-81CI	419153-011	VOLUTE U2B & 2BB CAST IRON	6 72807 05416 8
P41200	PW1-51CI	415290-011	VOLUTE 1 ¼AB CAST IRON	6 72807 05313 0
P41220	PW1-51CB	415290-041	VOLUTE 1 ¼AB BRONZE	6 72807 05315 4
P41240	PW2-51CI	415291-011	VOLUTE 1 ¼AB & U1 ¼A CAST IRON	6 72807 05317 8
P41260	PW2-51CB	415291-041	VOLUTE 1 ¼AB & U1 ¼A BRONZE	6 72807 05319 2
P41410	PW6-51CI	416168-011	VOLUTE U1 ¼B & 1 ¼BB CAST IRON	6 72807 05374 1
P41430	PW6-51CB	416168-041	VOLUTE U1 ¼B & 1 ¼BB BRONZE	6 72807 05376 5











NEW B&G	OLD B&G	ARMSTRONG	DESCRIPTION	UPC CODE
P41490	PW8-51CI	416167-011	VOLUTE 1 1/4BB CAST IRON	6 72807 05369 7
P41510	PW8-51CB	416167-041	VOLUTE 1 1/4BB BRONZE	6 72807 05372 7
P41690	PW1-61CI	415293-011	VOLUTE 1 1/2AB & U1 1/2A CAST IRON	6 72807 05325 3
P41710	PW1-61CB	415293-041	VOLUTE 1 1/2AB & U1 1/2A BRONZE	6 72807 05328 4
P41730	PW2-61CI	415292-011	VOLUTE 1 1/2AB CAST IRON	6 72807 05321 5
P41750	PW2-61CB	415292-041	VOLUTE 1 1/2AB BRONZE	6 72807 05323 9
P41780	PW3-61CI	425147-011	VOLUTE U1 1/2B & 1 1/2BB CAST IRON	6 72807 05644 5
P41800	PW3-61CB	425147-041	VOLUTE U1 1/2B & 1 1/2BB BRONZE	6 72807 05649 0
P41820	PW4-61CI	425146-011	VOLUTE 1 1/2BB CAST IRON	6 72807 05634 6
P41840	PW4-61CB	425146-041	VOLUTE 1 1/2BB BRONZE	6 72807 05639 1







NEW B&G	OLD B&G	ARMSTRONG	DESCRIPTION	UPC CODE
P41979	PW1-161CI	415299-011	VOLUTE 4AB & U4A CAST IRON	 6 72807 05342 0
P42030	PW2-81CI	425140-011	VOLUTE 2AB CAST IRON.I.	 6 72807 05613 1
P42050	PW2-81CB	425140-041	VOLUTE 2AB BRONZE	 6 72807 05615 5
P42070	PW3-81CI	425141-011	VOLUTE 2AB & U2A CAST IRON	 6 72807 05617 9
P42090	PW3-81CB	425141-041	VOLUTE 2AB & U2ABRONZE	 6 72807 05619 3
P42140	PW6-81CI	419153-011	VOLUTE U2B & 2BB CAST IRON	 6 72807 05416 8
P42160	PW6-81CB	419153-041	VOLUTE U2B & 2BB BRONZE	
P42200	PW8-81CI	419152-011	VOLUTE 2BB CAST IRON	 6 72807 05412 0
P42220	PW8-81CB	419152-041	VOLUTE 2BB BRONZE	 6 72807 05414 4
P42360	PW1-101CI	425143-011	VOLUTE 2 1/2A & U2 1/2A CAST IRON	 6 72807 05625 4







NEW B&G	OLD B&G	ARMSTRONG	DESCRIPTION	UPC CODE
P42380	PW1-101CB	425143-041	VOLUTE 2 ½A & U2 ½A BRONZE	 6 72807 05627 8
P42400	PW2-101CI	425142-011	VOLUTE 2 ½A CAST IRON	 6 72807 05621 6
P42440	PW2-101CB	415296-011	VOLUTE 2 ½B CAST IRON	 6 72807 05330 7
P42480	PW4-101CI	415297-011	VOLUTE U2 ½B & 2 ½B CAST IRON	 6 72807 05334 5
P42740	PW4-121CI	416180-011	VOLUTE U3B & 3BB CAST IRON	 6 72807 05382 6
P42770	PW4-121CB	416180-041	VOLUTE U3B & 3BB BRONZE	 6 72807 05384 0
P42820	PW6-121CI	416179-011	VOLUTE 3BB CAST IRON	 6 72807 05378 9
P42840	PW6-121CB	416179-041	VOLUTE 3BB BRONZE	 6 72807 05380 2
P43230	PW-161CI	415298-011	VOLUTE 4AB CAST IRON	 6 72807 05338 3
P43250	PW2-161CI	415300-011	VOLUTE 4BB CAST IRON	 6 72807 05346 8











NEW B&G	OLD B&G	ARMSTRONG	DESCRIPTION	UPC CODE
P43310	PW3-161CI	415301-011	VOLUTE U4B & 4BB CAST IRON	 6 72807 05350 5
P43590	PW-201CI	415302-011	VOLUTE 5BB CAST IRON	 6 72807 05352 9
P43620	PW1-201CI	415303-011	VOLUTE U5B & 5BB CAST IRON	 6 72807 05354 3
P43730	PW-241CI	416188-011	VOLUTE U6B & 6BB CAST IRON	 6 72807 05388 8
P43770	PW1-241CI	416187-011	VOLUTE 6BB CAST IRON	 6 72807 05386 4
P46510	PW17-535CI	411852-011	IMPELLER 1 ¼ AB CAST IRON	 6 72807 05241 6
P46510	PW17-535CI	411852-011	IMPELLER 1 ¼A CAST IRON	 6 72807 05241 6
P46630	PW27-535CB	411852-041	IMPELLER 1 ¼ AB BRONZE	 6 72807 05243 0
P46630	PW27-535CB	411852-041	IMPELLER 1 ¼A BRONZE	 6 72807 05243 0
P47810	PW8-635CI	411860-011	IMPELLER 1 ½AB CAST IRON	 6 72807 05245 4











NEW B&G	OLD B&G	ARMSTRONG	DESCRIPTION	UPC CODE
P47810	PW8-635CI	411860-011	IMPELLER 2AB CAST IRON	 6 72807 05245 4
P47810	PW8-635CI	411860-011	IMPELLER 1 1/2A CAST IRON	 6 72807 05245 4
P47810	PW8-635CI	411860-011	IMPELLER U2A CAST IRON	 6 72807 05245 4
P47950	PW13-635CBZ	411860-041	IMPELLER 1 1/2AB BRONZE	 6 72807 05247 8
P47950	PW13-635CBZ	411860-041	IMPELLER 2AB BRONZE	 6 72807 05247 8
P47950	PW13-635CBZ	411860-041	IMPELLER 1 1/2A BRONZE	 6 72807 05247 8
P47950	PW13-635CBZ	411860-041	IMPELLER U2A BRONZE	 6 72807 05247 8
P48050	PW18-635CI	419229-011	IMPELLER 1 1/2AB CAST IRON	 6 72807 05443 4
P48050	PW18-635CI	419229-011	IMPELLER 2ABCAST IRON	 6 72807 05443 4
P48070	PW18-635CB	419229-041	IMPELLER 1 1/2AB BRONZE	 6 72807 05445 8









NEW B&G	OLD B&G	ARMSTRONG	DESCRIPTION	UPC CODE
P48070	PW18-635CB	419229-041	IMPELLER 2AB BRONZE	 6 72807 05445 8
P48690	PW-854	406604-000	VOLUTE GASKET 1 1/4BB TO 5BB	 6 72807 04727 6
P48690	PW-854	406604-000	VOLUTE GASKET 1 1/4BB TO 6BB	 6 72807 04727 6
P48770	PW-1035CI	406642-011	IMPELLER 2 1/2A CAST IRON	 6 72807 04743 6
P48770	PW-1035CI	406642-011	IMPELLER 2 1/2A CAST IRON	 6 72807 04743 6
P48770	PW-1035CI	406642-011	IMPELLER 2 1/2A CAST IRON	 6 72807 04743 6
P48770	PW-1035CI	406642-011	IMPELLER 2 1/2A CAST IRON	 6 72807 04743 6
P48770	PW-1035CI	406642-011	IMPELLER 2 1/2A CAST IRON	 6 72807 04743 6
P48980	PW14-1035CI	419232-011	IMPELLER 2 1/2A CAST IRON	 6 72807 05447 2
P49000	PW15-1035CB	406642-041	IMPELLER 2 1/2A BRONZE	 6 72807 04745 0











NEW B&G	OLD B&G	ARMSTRONG	DESCRIPTION	UPC CODE
P49000	PW15-1035CB	406642-041	IMPELLER 2 1/2A BRONZE	 6 72807 04745 0
P49000	PW15-1035CB	406642-041	IMPELLER 2 1/2A BRONZE	 6 72807 04745 0
P49000	PW15-1035CB	406642-041	IMPELLER 2 1/2A BRONZE	 6 72807 04745 0
P49000	PW15-1035CB	406642-041	IMPELLER 2 1/2A BRONZE	 6 72807 04745 0
P49040	PW17-1035CBZ	419232-041	IMPELLER 2 1/2A BRONZE	 6 72807 05449 6
P49480	PW7-1235CI	411868-011	IMPELLER 3A CAST IRON	 6 72807 05250 8
P49500	PW7-1235CB	411868-041	IMPELLER 3A BRONZE	 6 72807 05252 2
P49520	PW8-1235CI	419234-011	IMPELLER 3A CAST IRON	 6 72807 05451 9
P49540	PW8-1235CB	419234-041	IMPELLER 3A BRONZE	 6 72807 05453 3
P49600	PW10-1235CI	419465-011	IMPELLER 3BB CAST IRON	 6 72807 05548 6









NEW B&G	OLD B&G	ARMSTRONG	DESCRIPTION	UPC CODE
P49600	PW10-1235CI	419465-011	IMPELLER 3B CAST IRON	 6 72807 05548 6
P49620	PW10-1235CB	419465-041	IMPELLER 3BB BRONZE	 6 72807 05550 9
P49620	PW10-1235CB	419465-041	IMPELLER 3B BRONZE	 6 72807 05550 9
P49640	PW11-1235CB	419241-041	IMPELLER 3BB BRONZE	 6 72807 05469 4
P49660	PW11-1235CI	419241-011	IMPELLER 3BB CAST IRON	 6 72807 05467 0
P49680	PW14-1035CI	419008-011	IMPELLER 3C CAST IRON	 6 72807 05400 7
P49700	PW1Z-1235CB	419008-041	IMPELLER 3C BRONZE	 6 72807 05402 1
P49940	PW1-1244CI	414498-011	COVERPLATE 3A TO 4AB C.I.	 6 72807 05298 0
P49960	PW1-1244CB	414498-041	COVERPLATE 3A TO 4AB BRZ.	 6 72807 05300 0
P50270	PW-1635CI	411874-041	IMPELLER 4 AB BRONZE	 6 72807 05256 0







NEW B&G	OLD B&G	ARMSTRONG	DESCRIPTION	UPC CODE
P50270	PW-1635CI	411874-041	IMPELLER 4A BRONZE	 6 72807 05256 0
P50270	PW-1635CI	411874-041	IMPELLER U6T BRONZE	 6 72807 05256 0
P50290	PW2-1635CI	419236-011	IMPELLER 4 AB CAST IRON	 6 72807 05455 7
P50310	PW2-1635CB	419236-041	IMPELLER 4 AB BRONZE	 6 72807 05457 1
P50330	PW3-1635CI	419243-011	IMPELLER 4BB CAST IRON	 6 72807 05471 7
P50390	PW8-1635CI	411940-011	IMPELLER 4BB CAST IRON	 6 72807 05273 7
P50390	PW8-1635CI	411940-011	IMPELLER U4B CAST IRON	 6 72807 05273 7
P50390	PW8-1635CI	411940-011	IMPELLER U11T CAST IRON	 6 72807 05273 7
P50430	PW5-1635CI	419009-011	IMPELLER 4C ACST IRON	 6 72807 05404 5
P50450	PW5-1635CB	419009-041	IMPELLER 4C BRONZE	 6 72807 05406 9









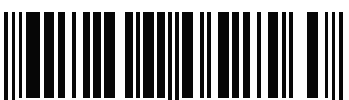

NEW B&G	OLD B&G	ARMSTRONG	DESCRIPTION	UPC CODE
P50550	PW8-1635CB	411940-041	IMPELLER 4BB BRONZE	 6 72807 05275 1
P50550	PW8-1635CB	411940-041	IMPELLER U4B BRONZE	 6 72807 05275 1
P50550	PW8-1635CB	411940-041	IMPELLER U11T BRONZE	 6 72807 05275 1
P50570	PW9-1635CBZ	419243-041	IMPELLER 4BB BRONZE	 6 72807 05473 1
P50670	PW-1644CI	419467-011	COVERPLATE 2C TO 8C C.I.	 6 72807 05552 3
P50910	PW-2035CI	411941-011	IMPELLER 5BB CAST IRON	 6 72807 05277 5
P50910	PW-2035CI	411941-011	IMPELLER U5B CAST IRON	 6 72807 05277 5
P50910	PW-2035CI	411941-011	IMPELLER U8T CAST IRON	 6 72807 05277 5
P50910	PW-2035CI	411941-011	IMPELLER U10T CAST IRON	 6 72807 05277 5
P50910	PW-2035CI	411941-011	IMPELLER U12T CAST IRON	 6 72807 05277 5

NEW B&G	OLD B&G	ARMSTRONG	DESCRIPTION	UPC CODE
P50930	PW-2035CB	411941-041	IMPELLER 5BB BRONZE	 6 72807 05279 9
P50930	PW-2035CB	411941-041	IMPELLER U5B BRONZE	 6 72807 05279 9
P50930	PW-2035CB	411941-041	IMPELLER U8T BRONZE	 6 72807 05279 9
P50930	PW-2035CB	411941-041	IMPELLER U10T BRONZE	 6 72807 05279 9
P50930	PW-2035CB	411941-041	IMPELLER U12T BRONZE	 6 72807 05279 9
P50950	PW1-2035CI	419245-011	IMPELLER 5BB CAST IRON	 6 72807 05475 5
P50970	PW1-2035CB	419245-041	IMPELLER 5BB BRONZE	 6 72807 05477 9
P51270	PW-2435CI	419247-011	IMPELLER 6BB CAST IRON	 6 72807 05479 3
P51270	PW-2435CI	419247-011	IMPELLER U6B ACST IRON	 6 72807 05479 3
P51270	PW-2435CI	419247-011	IMPELLER U13 OR 14T CAST IRON	 6 72807 05479 3

NEW B&G	OLD B&G	ARMSTRONG	DESCRIPTION	UPC CODE
P51290	PW-2435CB	419247-041	IMPELLER 6BB BRONZE	 6 72807 05481 6
P51290	PW-2435CB	419247-041	IMPELLER U6B BRONZE	 6 72807 05481 6
P51290	PW-2435CB	419247-041	IMPELLER U13 OR 14T BRONZE	 6 72807 05481 6
P51350	PW2-2435CI	419541-011	IMPELLER 6C CAST IRON	 6 72807 05562 2
P51370	PW2-2435CB	419541-041	IMPELLER 6C CAST IRON	 6 72807 05564 6
P51540	PW-2444CI	411896-011	COVERPLATE 1 1/4BB TO 6BB C.I.	 6 72807 05265 2
P51560	PW-2444CB	411896-041	COVERPLATE 1 1/4BB TO 6BB BRZ.	 6 72807 05269 0
P53020	PW15-5282CI	419166-012	M/P BRKT. 1 1/4BB-6BB B.F. - A.I.	 6 72807 05425 0
P53040	PW15-5282CB	419170-042	M/P BRKT. 1 1/4BB-6BB A.B.	 6 72807 05430 4
P53500	PW-6282CI	411883-012	M/P BRKT. 1 1/4BB-6BB B.F. - A.I.	 6 72807 05262 1





NEW B&G	OLD B&G	ARMSTRONG	DESCRIPTION	UPC CODE
P53540	PWB-6282	419171-042	M/P BRKT. 1 ¼BB-6BB A.B.	 6 72807 05431 1
P53550	PW-6286	406622-000	WATER SLINGER 1 ¼"	 6 72807 04736 8
P53690	PW-8282CI	419164-012	M/P BRKT. 1 ¼AB-4AB B.F. - A.I.	 6 72807 05419 9
P53710	PW-8282CB	419168-042	M/P BRKT. 1 ¼AB-4AB A.B.	 6 72807 05428 1
P53720	PW-8286	419315-000	WATER SLINGER 1 ⅝"	 6 72807 05499 1
P53880	PW-12282CI	419165-012	M/P BRKT. 1 ¼AB-4AB B.F. - A.I.	 6 72807 05422 9
P53900	PW-12282CB	419165-042	M/P BRKT. 1 ¼AB-4AB A.B.	
P55150	PWB2-101	425142-041	VOLUTE 2 ½A BRONZE	 6 72807 05623 0
P55170	PWB3-101	415296-041	VOLUTE 2 ½B BRONZE.	 6 72807 05332 1
P55190	PW4-101CB	415297-041	VOLUTE U2 ½B & 2 ½B BRONZE	 6 72807 05336 9

NEW B&G	OLD B&G	ARMSTRONG	DESCRIPTION	UPC CODE
P55190	PWB4-101	415297-041	VOLUTE U2 ½B & 2 ½B BRONZE	 6 72807 05336 9
P55250	PWB-161	415298-041	VOLUTE 4AB BRONZE.	 6 72807 05340 6
P55280	PWB1-161	415299-041	VOLUTE 4AB & U4A BRONZE.	 6 72807 05344 4
P55300	PWB2-161	415300-041	VOLUTE 4BB BRONZE.	 6 72807 05348 2
P55320	PWB3-161	415301-041	VOLUTE U4B & 4BB BRONZE.	
P55340	PWB-201	415302-041	VOLUTE 5BB BRONZE.	
P55360	PWB1-201	415303-041	VOLUTE U5B & 5BB BRONZE.	 6 72807 05355 0
P56140	PW-1635CB	411874-041	IMPELLER 4 AB BRONZE	 6 72807 05256 0
P56140	PW-1635CB	411874-041	IMPELLER 4A BRONZE	 6 72807 05256 0
P56140	PW-1635CB	411874-041	IMPELLER U6T BRONZE	 6 72807 05256 0











NEW B&G	OLD B&G	ARMSTRONG	DESCRIPTION	UPC CODE
P56779	PWB4Z-544	409564-041	COVERPLATE 1 3/4A TO 4AB A.B.	 6 72807 04826 6
P56799	PWB6Z-1044	409563-041	COVERPLATE 1 3/4BB TO 5BB A.B.	 6 72807 04815 0
P56929	PWBZ-5282	409026-042	M/P BRKT. 1 3/4AB-4AB A.B.	 6 72807 04806 8
P56939	PWB2Z-5282	406931-042	M/P BRKT. 1 3/4AB-4AB A.B.	 6 72807 04766 5
P56949	PWB4Z-5282	406953-042	M/P BRKT. 1 3/4BB-5BB A.B.	 6 72807 04783 2
P56969	PWB8Z-5282	409023-042	M/P BRKT. 1 3/4BB-5BB A.B.	 6 72807 04800 6
P57200	PWHB-81	816338-041	BRONZE BODY 60-4 (OLD) 60-14 (NEW)	 6 72807 28521 0
P57410	PWH1-554	106158-000	BODY GASKET PD35, PD37, 60-11 TO 60-14	 6 72807 01167 3
P57440 (CI)		816309-041	BRONZE IMPELLER, 7", FITS 60 1-3/2A	 6 72807 28509 8
P57445 (BR)		816309-041	BRONZE IMPELLER, 7", FITS 60 1-3/2A	 6 72807 28509 8





NEW B&G	OLD B&G	ARMSTRONG	DESCRIPTION	UPC CODE
P57450 (BR)		816310-041	BRONZE IMPELLER, 7", FITS 60 2A	6 72807 28510 4
P57580 (CI)		816310-041	BRONZE IMPELLER, 7", FITS 60 2A	6 72807 28510 4
P57700	PWH-1054	106592-000	BODY GASKET PD39, 60-15 TO 60-21	6 72807 01282 3
P57700	PWH-1054	106592-000	VOLUTE GASKET 1 3/4A TO 4AB	6 72807 01282 3
P57770	PWH-1654	419016-000	VOLUTE GASKET 2C TO 8C	6 72807 05410 6
P61010	PW23Z-535	816303-017	STEEL IMPELLER 60-13	6 72807 28472 5
P63239		819348-002	COUPLER 7J	6 72807 28648 4
P63242		819349-002	COUPLER 8J	6 72807 28649 1
P63245		819350-002	COUPLER 9E	6 72807 28650 7
P77073	P2600C-1658R	425392-042	M/P BRKT. 1 3/4AB-4AB A.B.	6 72807 05739 8

NEW B&G	OLD B&G	ARMSTRONG	DESCRIPTION	UPC CODE
P77073	P2600C-1658R	425392-042	M/P BRKT. 1 ¼AB-4AB A.B.	6 72807 05739 8
P77076	P2600T-1658P	425392-012	M/P BRKT. 1 ¼AB-4AB B.F. - A.I.	6 72807 05737 4
P77166	P2601T-1658P	425393-012	M/P BRKT. 1 ¼BB-6BB B.F. - A.I.	6 72807 05740 4
P77169	P2601C-1658P	425393-042	M/P BRKT. 1 ¼BB-6BB A.B.	6 72807 05741 1
P77265		816665-000	COUPLER 5/8" x 5/8" FLEX	6 72807 28594 4
P77497		419543-041	IMPELLER 2C BRONZE	6 72807 05572 1
P77499		419543-011	IMPELLER 2CCAST IRON	6 72807 05570 7
P78251	PW6-635CB	419238-041	IMPELLER 1 ¼BB BRONZE	6 72807 05461 8
P78251	PW6-635CB	419238-041	IMPELLER 1 ½BBBRONZE	6 72807 05461 8
P78253	PW7-635CI	407922-011	IMPELLER 1 ¼BB CAST IRON	6 72807 04791 7

NEW B&G	OLD B&G	ARMSTRONG	DESCRIPTION	UPC CODE
P78253	PW7-635CI	407922-011	IMPELLER 1 1/2" B CAST IRON	 6 72807 04791 7
P78253	PW7-635CI	407922-011	IMPELLER 1 1/4" B CAST IRON	 6 72807 04791 7
P78253	PW7-635CI	407922-011	IMPELLER U1 1/2" B CAST IRON	 6 72807 04791 7
P78255	PW9-1035CB	419239-041	IMPELLER 2 1/2" B BRONZE	 6 72807 05465 6
P78257	PW9-1035CI	419239-011	IMPELLER 2" B B CAST IRON	 6 72807 05463 2
P78257	PW9-1035CI	419239-011	IMPELLER 2 1/2" B CAST IRON	 6 72807 05463 2
P78486	PW4-1035CI	411881-011	IMPELLER 2" B B CAST IRON	 6 72807 05258 4
P78486	PW4-1035CI	411881-011	IMPELLER 2" B B ACST IRON	 6 72807 05258 4
P78486	PW4-1035CI	411881-011	IMPELLER 2" B CAST IRON	 6 72807 05258 4
P78486	PW4-1035CI	411881-011	IMPELLER U2 1/2" B CAST IRON	 6 72807 05258 4

NEW B&G	OLD B&G	ARMSTRONG	DESCRIPTION	UPC CODE
P78486	PW4-1035CI	411881-011	IMPELLER U5T CAST IRON	 6 72807 05258 4
P78486	PW4-1035CI	411881-011	IMPELLER U7T CAST IRON	 6 72807 05258 4
P78486	PW4-1035CI	411881-011	IMPELLER U9T CAST IRON	 6 72807 05258 4
P78522	PW9-635CI	419238-011	IMPELLER 1 ¼BB CAST IRON	 6 72807 05459 5
P78522	PW9-635CI	419238-011	IMPELLER 1 ½BB CAST IRON	 6 72807 05459 5
P78523	PW10-635CB	407922-041	IMPELLER 1 ¼BB BRONZE	 6 72807 04793 1
P78523	PW10-635CB	407922-041	IMPELLER 1 ½BB BRONZE	 6 72807 04793 1
P78523	PW10-635CB	407922-041	IMPELLER 1 ¾B BRONZE	 6 72807 04793 1
P78523	PW10-635CB	407922-041	IMPELLER U1 ½B BRONZE	 6 72807 04793 1
P78525	PW11-1035CBZ	411881-041	IMPELLER 2BB BRONZE	 6 72807 05260 7

NEW B&G	OLD B&G	ARMSTRONG	DESCRIPTION	UPC CODE
P78525	PW11-1035CBZ	411881-041	IMPELLER 2BB BRONZE	 6 72807 05260 7
P78525	PW11-1035CBZ	411881-041	IMPELLER 2BB BRONZE	 6 72807 05260 7
P78525	PW11-1035CBZ	411881-041	IMPELLER 2B BRONZE	 6 72807 05260 7
P78525	PW11-1035CBZ	411881-041	IMPELLER U2 1/2B BRONZE	 6 72807 05260 7
P78525	PW11-1035CBZ	411881-041	IMPELLER U5T BRONZE	 6 72807 05260 7
P78525	PW11-1035CBZ	411881-041	IMPELLER U7T BRONZE	 6 72807 05260 7
P78525	PW11-1035CBZ	411881-041	IMPELLER U9T BRONZE	 6 72807 05260 7
P78729		875000-802	COUPLER INSERT 5J	 6 72807 28819 8
P78791		875000-803	COUPLER INSERT 6J	 6 72807 28820 4
P78792		875000-804	COUPLER INSERT 7J	 6 72807 28821 1







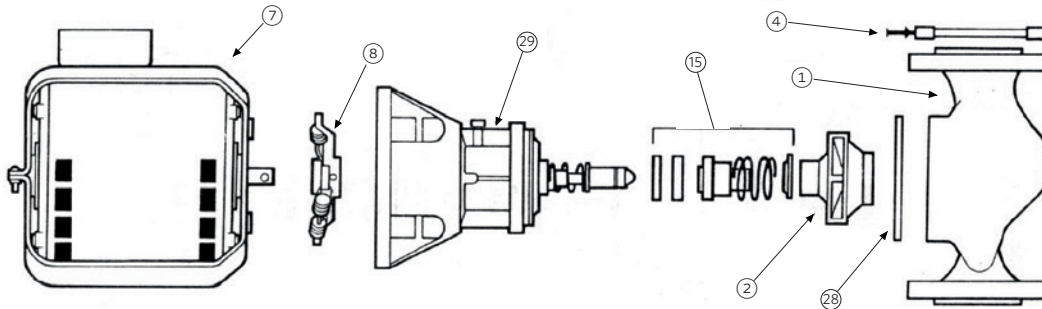

NEW B&G	OLD B&G	ARMSTRONG	DESCRIPTION	UPC CODE
P78794		875000-805	COUPLER INSERT 8J	 6 72807 28822 8
P78796		875000-807	COUPLER INSERT 9J	 6 72807 28823 5
P78804		875000-801	COUPLER INSERT 4J	 6 72807 28818 1
PW-121CI	PW-121CI	425145-011	VOLUTE3A & U3A CAST IRON	 6 72807 05631 5
PW1-121CB	PW1-121CB	425144-041	VOLUTE 3A BRONZE	
PW1-121CI	PW1-121CI	425144-011	VOLUTE 3A CAST IRON	 6 72807 05629 2
PWB-121	PWB-121	425145-041	VOLUTE3A & U3A BRONZE	

CIRCULATORS PARTS CROSS REFERENCE

Armstrong S-25 STD/BF/AB

MODEL NUMBER	
ITT / B&G 75 TO 150	ARMSTRONG S-25 STD/BF/AB



ITEM NO.	PART DESCRIPTION	PART NUMBER		UPC CODE
		ARMSTRONG	B&G	
7	1/12 HP MOTOR	805316-010	111034	
29	UNIVERSAL SEAL BEARING ASSEMBLY (W/NORYL IMPELLER)	810119-001	118844	
29	UNIVERSAL SEAL BEARING ASSEMBLY (W/NORYL IMPELLER)	810119-001	189034	
2	BRONZE IMPELLER	812961-041	118431	
2	STEEL IMPELLER	812961-011	118840	
2	NORYL IMPELLER	812961-111	189132	
8	COUPLER	806026-001	189110/118705	
28	BODY GASKET	104442-000	P04080	
4	FLANGE GASKET	805176-000*	118368	

ITEM NO.	PART DESCRIPTION	PART NUMBER		UPC CODE
		ARMSTRONG	B&G	
4	FLANGE GASKET KIT	816653-000	ARMSTRONG ONLY	6 72807 28593 7
15	SEAL KIT	816706-021	118681	6 72807 28602 6
1	BRONZE BODY	805482-041	118413	6 72807 28127 4
1	CAST IRON BODY	805482-011	118339	6 72807 28126 7

NOTE: *Gasket kit contains 2 - 116653-000 Gaskets and 2 - 105176-000 Gaskets.
For Flanges: See Flanges cross reference sheet.

Armstrong S-34 STD/BF/AB







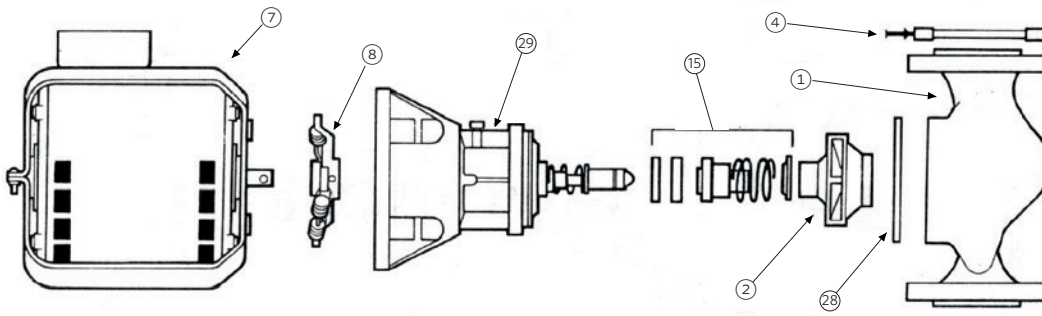

MODEL NUMBER

ITT / B&G 1 1/2" (DISCONTINUED 12/76)

ARMSTRONG S-34 STD/BF/AB



ITEM NO.	PART DESCRIPTION	PART NUMBER		UPC CODE
		ARMSTRONG	B&G	
7	1/2 HP MOTOR	817025-001	111036, 111031	6 72807 28628 6
29	UNIVERSAL SEAL BEARING ASSEMBLY (W/NORYL IMPELLER)	810119-003	189101	6 72807 28184 7
29	UNIVERSAL SEAL BEARING ASSEMBLY (W/NORYL IMPELLER)	810119-003	189103	6 72807 28184 7

ITEM NO.	PART DESCRIPTION	PART NUMBER		UPC CODE
		ARMSTRONG	B&G	
2	BRONZE IMPELLER	816322-042	N/A	 6 72807 28513 5
2	STEEL IMPELLER	816322-012	N/A	N/A
2	NORYL IMPELLER	806331-111	118435/118666	 6 72807 28155 7
8	COUPLER	806026-001	118705/189110	 6 72807 28131 1
28	BODY GASKET	106049-000	P04890	 6 72807 01132 1
4	FLANGE GASKET PRIOR 1967	804034-000	118373	 6 72807 28103 8
4	FLANGE GASKET NEW	N/A	N/A	N/A
15	SEAL KIT	816706-021	118681	 6 72807 28602 6
1	BRONZE BODY	816402-041	N/A	 6 72807 28561 6
1	CAST IRON BODY	816402-011	N/A	 6 72807 28560 9

Armstrong S-35 BF/AB

MODEL NUMBER

ITT / B&G 2" (MFTD. PRIOR TO 7/76, DATE CODE GT)

ARMSTRONG S-35 BF/AB

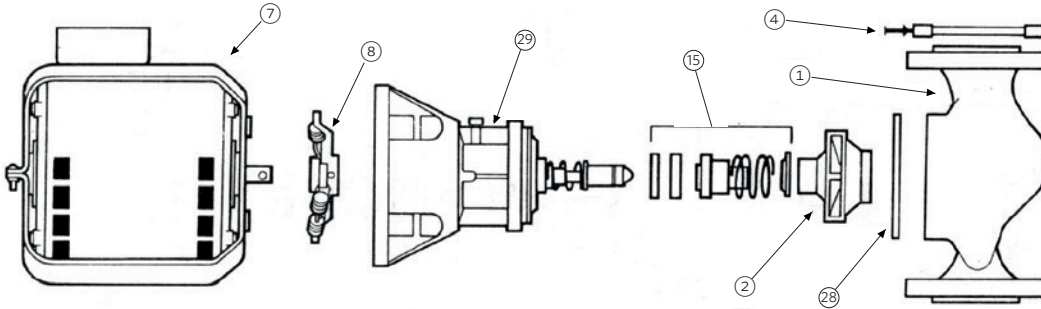

ITEM NO.	PART DESCRIPTION	PART NUMBER		UPC CODE
		ARMSTRONG	B&G	
7	1/2 HP MOTOR	817025-001	111036, 111031	6 72807 28628 6
29	UNIVERSAL SEAL BEARING ASSEMBLY (W/NORYL IMPELLER)	810119-003	189100	6 72807 28184 7
29	UNIVERSAL SEAL BEARING ASSEMBLY (W/NORYL IMPELLER)	810119-003	189103	6 72807 28184 7
2	BRONZE IMPELLER	816556-041	118436	6 72807 28569 2
2	STEEL IMPELLER	816556-011	118668	6 72807 28568 5
8	COUPLER	806026-001	118705/189110	6 72807 28131 1
28	BODY GASKET	106049-000	P04890	6 72807 01132 1
4	FLANGE GASKET PRIOR 1967	805209-000	118065	6 72807 28123 6
4	FLANGE GASKET NEW	N/A	N/A	N/A

ITEM NO.	PART DESCRIPTION	PART NUMBER		UPC CODE
		ARMSTRONG	B&G	
15	SEAL KIT	816706-021	118681	6 72807 28602 6
1	BRONZE BODY	816327-041	N/A	6 72807 28517 3
1	CAST IRON BODY	816327-011	N/A	6 72807 28516 6

NOTE: For Flanges: See Flanges cross reference sheet.

Armstrong H-32 BF/AB

MODEL NUMBER





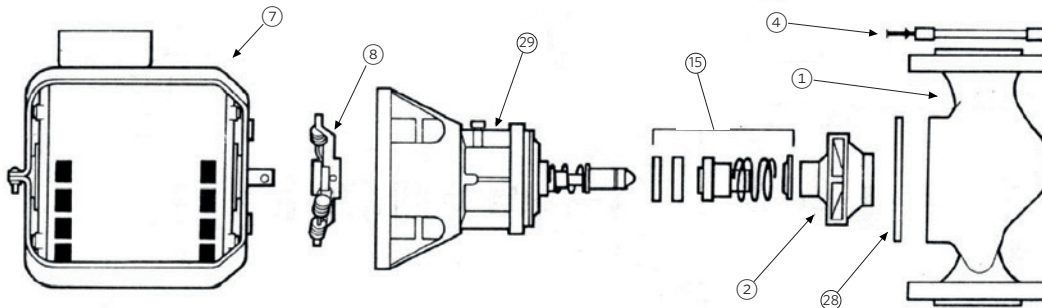



ITT / B&G HV (MFTD. PRIOR TO 4/76, DATE CODE DT)

ARMSTRONG H-32 BF/AB



ITEM NO.	PART DESCRIPTION	PART NUMBER		UPC CODE
		ARMSTRONG	B&G	
7	1/2 HP MOTOR	817025-001	111036, 111031	6 72807 28628 6
29	UNIVERSAL SEAL BEARING ASSEMBLY (W/NORYL IMPELLER)	810119-003	189101/189102	6 72807 28184 7
29	UNIVERSAL SEAL BEARING ASSEMBLY (W/NORYL IMPELLER)	810119-003	189103	6 72807 28184 7
2	BRONZE IMPELLER	816322-041	118436	6 72807 28513 5

42

ITEM NO.	PART DESCRIPTION	PART NUMBER		UPC CODE
		ARMSTRONG	B&G	
2	STEEL IMPELLER	816322-011	118668	
2	NORYL IMPELLER	816322-111	N/A	
8	COUPLER	806026-001	118705/189110	
28	BODY GASKET	106049-000	P04890	
4	FLANGE GASKET PRIOR 1967	804034-000	118373	
4	FLANGE GASKET NEW	N/A	N/A	N/A
15	SEAL KIT	816706-021	118681	
1	BRONZE BODY	816402-041	118642	
1	CAST IRON BODY	816402-011	118641	

NOTE: For Flanges: See Flanges cross reference sheet.

Armstrong S-35 FOR B&G PUMPS ONLY

MODEL NUMBER

ITT / B&G 2" (MFTD. 7/76 OR AFTER, DATE CODE DT)

ARMSTRONG S-35 FOR B&G PUMPS ONLY

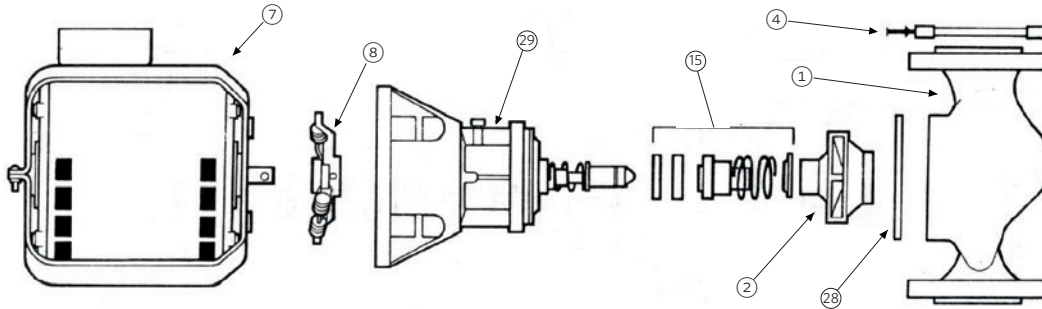

ITEM NO.	PART DESCRIPTION	PART NUMBER		UPC CODE
		ARMSTRONG	B&G	
7	½ HP MOTOR	817025-005	111061	6 72807 28629 3
29	SEAL BEARING ASSEMBLY (STD./B.F.)	816023-001	189120,21,22,29	6 72807 28432 9
29	SEAL BEARING ASSEMBLY (A.B.)	816023-001	189131	6 72807 28432 9
2	BRONZE IMPELLER	N/A	189128	N/A
2	STEEL IMPELLER	N/A	P07792	N/A
2	NORYL IMPELLER	N/A	N/A	N/A
8	COUPLER	806026-001	118705/189110	6 72807 28131 1
28	BODY GASKET	106049-000	P04890	6 72807 01132 1
4	FLANGE GASKET	805209-000	118065	6 72807 28123 6
4	FLANGE GASKET NEW	N/A	N/A	N/A





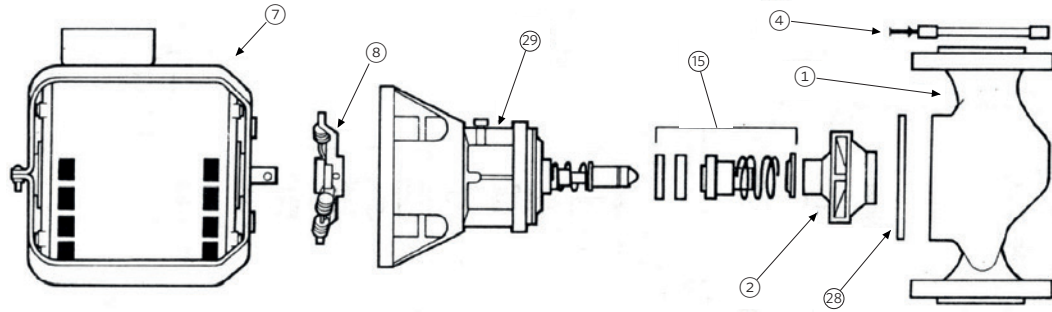

ITEM NO.	PART DESCRIPTION	PART NUMBER		UPC CODE
		ARMSTRONG	B&G	
15	SEAL KIT	816706-021	118681	6 72807 28602 6
1	BRONZE BODY	N/A	189127	N/A
1	CAST IRON BODY	N/A	189126	N/A

Armstrong S-45 BF 2 1/2" FLANGE

MODEL NUMBER	
ITT / B&G 2 1/2"	ARMSTRONG S-45 BF 2 1/2" FLANGE



ITEM NO.	PART DESCRIPTION	PART NUMBER		UPC CODE
		ARMSTRONG	B&G	
7	1/4 HP MOTOR	817025-007	111040	6 72807 28630 9
29	SEAL BEARING ASSEMBLY (STD./B.F.)	816027-002	189105	6 72807 28433 6
29	SEAL BEARING ASSEMBLY (A.B.)	816027-002	118447/189106	6 72807 28433 6
2	BRONZE IMPELLER	816305-058	118440	6 72807 28503 6
2	STEEL IMPELLER	816305-028	118676	6 72807 28501 2
2	NORYL IMPELLER	816305-328	N/A	6 72807 28505 0

ITEM NO.	PART DESCRIPTION	PART NUMBER		UPC CODE
		ARMSTRONG	B&G	
8	COUPLER	806168-001	118723	 6 72807 28148 9
28	BODY GASKET	106050-000	P05800	 6 72807 01133 8
4	FLANGE GASKET	805201-000	118129	 6 72807 28122 9
4	FLANGE GASKET NEW	N/A	N/A	N/A
15	SEAL KIT	816706-021	118681	 6 72807 28602 6
1	BRONZE BODY	805484-041	P07610	 6 72807 28129 8
1	CAST IRON BODY	805484-011	118644	 6 72807 28128 1

Armstrong s-45 3" FLANGE

MODEL NUMBER

ITT / B&G LD3

ARMSTRONG S-45 3" FLANGE

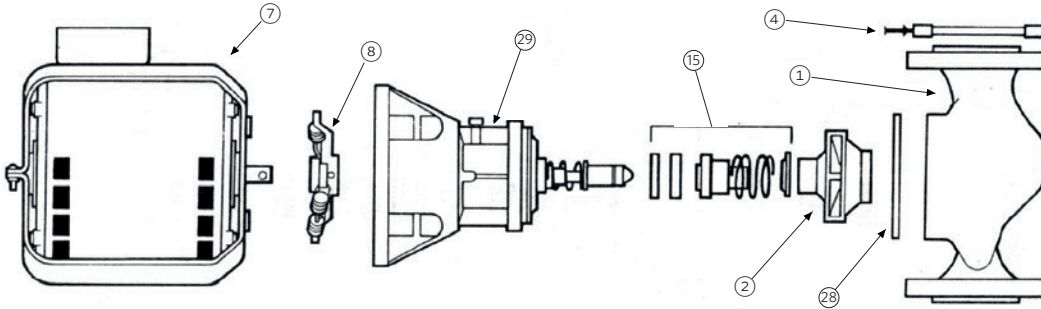

ITEM NO.	PART DESCRIPTION	PART NUMBER		UPC CODE
		ARMSTRONG	B&G	
7	¼ HP MOTOR	817025-007	111040	6 72807 28630 9
29	SEAL BEARING ASSEMBLY (STD./B.F.)	816027-002	189105	6 72807 28433 6
29	SEAL BEARING ASSEMBLY (A.B.)	816027-002	118447/189106	6 72807 28433 6
2	BRONZE IMPELLER	816305-058	118440	6 72807 28503 6
2	STEEL IMPELLER	816305-028	118676	6 72807 28501 2
2	NORYL IMPELLER	816305-328	N/A	6 72807 28505 0
8	COUPLER	806168-001	118723	6 72807 28148 9
28	BODY GASKET	106050-000	P05800	6 72807 01133 8
4	FLANGE GASKET	805201-000	118129	6 72807 28122 9

ITEM NO.	PART DESCRIPTION	PART NUMBER		UPC CODE
		ARMSTRONG	B&G	
4	FLANGE GASKET NEW	N/A	N/A	N/A
15	SEAL KIT	816706-021	118681	6 72807 28602 6
1	BRONZE BODY	805484-041	P07610	6 72807 28129 8
1	CAST IRON BODY	805484-011	118644	6 72807 28128 1

Armstrong s-46

MODEL NUMBER

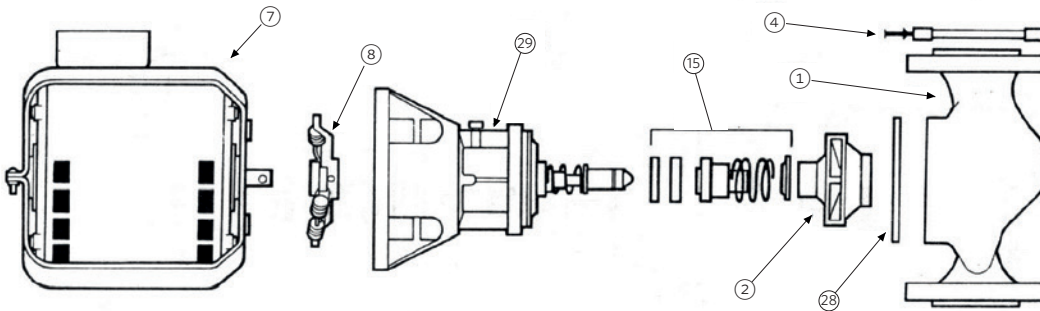

ITT / B&G HD3

ARMSTRONG S-46



ITEM NO.	PART DESCRIPTION	PART NUMBER		UPC CODE
		ARMSTRONG	B&G	
7	1/2 HP MOTOR	817025-013	111042	6 72807 28631 6
29	SEAL BEARING ASSEMBLY (STD./B.F.)	816027-002	189105	6 72807 28433 6
29	SEAL BEARING ASSEMBLY (A.B.)	816027-002	118447/189106	6 72807 28433 6
2	BRONZE IMPELLER	816322-041	118439	6 72807 28502 9

48

ITEM NO.	PART DESCRIPTION	PART NUMBER		UPC CODE
		ARMSTRONG	B&G	
2	STEEL IMPELLER	816305-025	118675	 6 72807 28500 5
2	NORYL IMPELLER	816305-328	N/A	 6 72807 28505 0
8	COUPLER	806168-001	118723	 6 72807 28148 9
28	BODY GASKET	106050-000	P05800	 6 72807 01133 8
4	FLANGE GASKET	805201-000	118129	 6 72807 28122 9
4	FLANGE GASKET NEW	N/A	N/A	N/A
15	SEAL KIT	816706-021	118681	 6 72807 28602 6
1	BRONZE BODY	805484-041	P07610	 6 72807 28129 8
1	CAST IRON BODY	805484-011	118644	 6 72807 28128 1

Armstrong H-41 BF & AB

MODEL NUMBER

ITT / B&G 1 PR

ARMSTRONG H-41 BF & AB

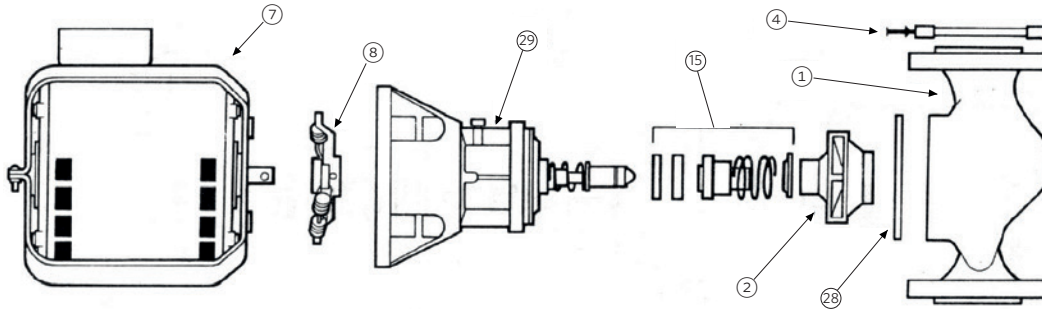

ITEM NO.	PART DESCRIPTION	PART NUMBER		UPC CODE
		ARMSTRONG	B&G	
7	½ HP MOTOR	817025-001	111036/111031	6 72807 28628 6
29	SEAL BEARING ASSEMBLY (STD./B.F.)	816027-002	189105	6 72807 28433 6
29	SEAL BEARING ASSEMBLY (A.B.)	816027-002	118447/189106	6 72807 28433 6
2	BRONZE IMPELLER	816301-055	118612	6 72807 28455 8
2	STEEL IMPELLER	816301-025	118830	6 72807 28454 1
2	NORYL IMPELLER	816301-325	N/A	6 72807 28456 5
8	COUPLER	806026-001	118705/189110	6 72807 28131 1
28	BODY GASKET	106050-000	P05800	6 72807 01133 8
4	FLANGE GASKET	805176-000	118368	6 72807 28116 8
4	FLANGE GASKET NEW	N/A	N/A	N/A

50







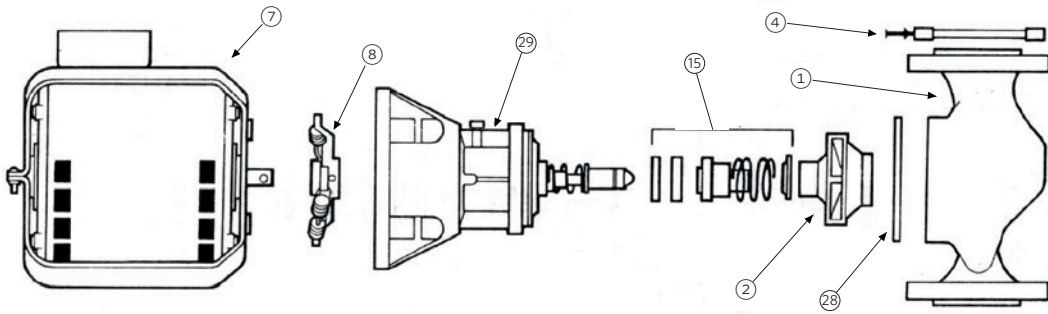

ITEM NO.	PART DESCRIPTION	PART NUMBER		UPC CODE
		ARMSTRONG	B&G	
15	SEAL KIT	816706-021	118681	6 72807 28602 6
1	BRONZE BODY	811240-041	P07570	6 72807 28374 2
1	CAST IRON BODY	811240-011	118637	6 72807 28373 5

Armstrong S-55 (STANDARD CONSTRUCTION IS BRONZE FITTED)

MODEL NUMBER	ARMSTRONG S-55 (STANDARD CONSTRUCTION IS BRONZE FITTED)
ITT / B&G PD-35	



ITEM NO.	PART DESCRIPTION	PART NUMBER		UPC CODE
		ARMSTRONG	B&G	
7	½ HP MOTOR 1PH/60/115/230	811757-001	111044	6 72807 28380 3
7	½ HP MOTOR 3PH/60/208/230/460	811757-020	111046	N/A
29	SEAL BEARING ASSEMBLY (STD./B.F.)	816032-000	186863	6 72807 28437 4
29	SEAL BEARING ASSEMBLY (A.B.)	816032-000	186864	6 72807 28437 4
2	BRONZE IMPELLER	816304-051	118627	6 72807 28488 6

ITEM NO.	PART DESCRIPTION	PART NUMBER		UPC CODE
		ARMSTRONG	B&G	
2	STEEL IMPELLER	816304-021	118630	 6 72807 28485 5
8	NORYL IMPELLER	816304-321	N/A	 6 72807 28491 6
8	COUPLER 1/2" x 5/8"	806137-000	118709	 6 72807 28143 4
8	COUPLER 1/2" x 3/4"	806140-000	118708	 6 72807 28145 8
28	BODY GASKET	106158-000	P57410	 6 72807 01167 3
4	FLANGE GASKET	805201-000	118129	 6 72807 28122 9
15	SEAL KIT	816706-021	118681	 6 72807 28602 6
1	BRONZE BODY	804133-041	P09290	 6 72807 28105 2
1	CAST IRON BODY	804133-011	118449	 6 72807 28104 5

Armstrong S-57 (STANDARD CONSTRUCTION IS BRONZE FITTED)



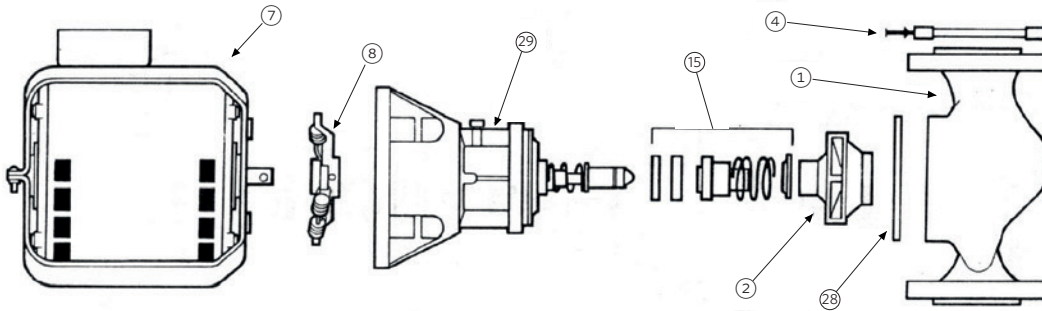

MODEL NUMBER

ITT / B&G PD-37

ARMSTRONG S-57 (STANDARD CONSTRUCTION IS BRONZE FITTED)



ITEM NO.	PART DESCRIPTION	PART NUMBER		UPC CODE
		ARMSTRONG	B&G	
7	¾ HP MOTOR 1PH/60/115/230	811757-002	111047	6 72807 28381 0
7	¾ HP MOTOR 3PH/60/208/230/460	811757-024	111049	N/A
29	SEAL BEARING ASSEMBLY (STD./B.F.)	816032-000	186863	6 72807 28437 4
29	SEAL BEARING ASSEMBLY (A.B.)	816032-000	186864	6 72807 28437 4
2	BRONZE IMPELLER	816304-047	118626	6 72807 28487 9
2	STEEL IMPELLER	816304-027	118629	6 72807 28486 2
2	NORYL IMPELLER	816304-317	N/A	6 72807 28484 8
8	COUPLER ½" x ⅝"	806137-000	118709	6 72807 28143 4
8	COUPLER ½" x ¾"	806140-000	118708	6 72807 28145 8

ITEM NO.	PART DESCRIPTION	PART NUMBER		UPC CODE
		ARMSTRONG	B&G	
28	BODY GASKET	106158-000	P57410	 6 72807 01167 3
4	FLANGE GASKET	805201-000	118129	 6 72807 28122 9
15	SEAL KIT	816706-021	118681	 6 72807 28602 6
1	BRONZE BODY	804133-041	P09290	 6 72807 28105 2
1	CAST IRON BODY	804133-011	118449	 6 72807 28104 5

Armstrong H-51 (STANDARD CONSTRUCTION IS BRONZE FITTED)

MODEL NUMBER

ITT / B&G 60-1 (OLD), 60-11 (NEW)

ARMSTRONG H-51 (STANDARD CONSTRUCTION IS BRONZE FITTED)

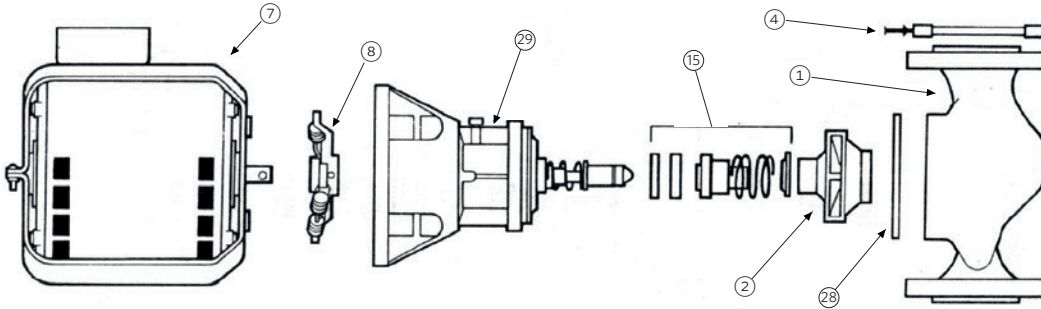

ITEM NO.	PART DESCRIPTION	PART NUMBER		UPC CODE
		ARMSTRONG	B&G	
7	¼ HP MOTOR 1PH/60/115/230	816141-001	111040	6 72807 28448 0
29	SEAL BEARING ASSEMBLY (STD./B.F.)	816032-000	186863	6 72807 28437 4
29	SEAL BEARING ASSEMBLY (A.B.)	816032-000	186864	6 72807 28437 4
2	BRONZE IMPELLER	816302-049	186359/186360	6 72807 28463 3
2	STEEL IMPELLER	816302-019	186441	6 72807 28458 9
2	NORYL IMPELLER	816302-319	N/A	6 72807 28468 8
8	COUPLER	807436-000	118473	6 72807 28170 0
28	BODY GASKET	106158-000	P57410	6 72807 01167 3
4	FLANGE GASKET	805176-000	118368	6 72807 28116 8

ITEM NO.	PART DESCRIPTION	PART NUMBER		UPC CODE
		ARMSTRONG	B&G	
15	SEAL KIT	816706-021	118681	6 72807 28602 6
1	BRONZE BODY	816337-041	186385	6 72807 28519 7
1	CAST IRON BODY	816337-011	186384	6 72807 28518 0

Armstrong H-52 BF SINGLE PHASE (STANDARD CONSTRUCTION IS BRONZE FITTED)

MODEL NUMBER





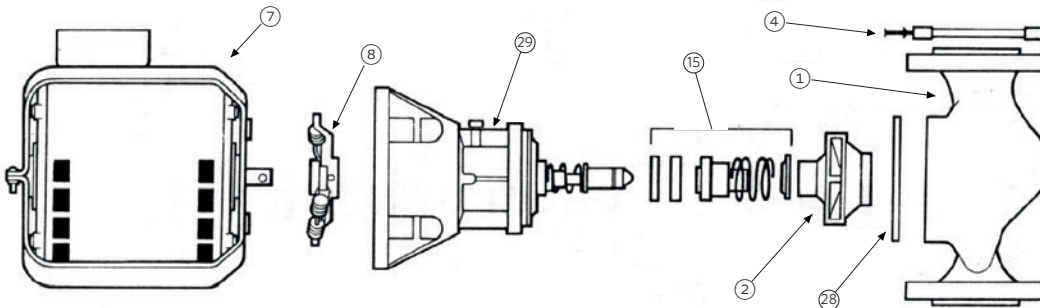

ITT / B&G 60-2 (OLD)

ARMSTRONG H-52 BF SINGLE PHASE
(STANDARD CONSTRUCTION IS BRONZE FITTED)



ITEM NO.	PART DESCRIPTION	PART NUMBER		UPC CODE
		ARMSTRONG	B&G	
7	1/2 HP MOTOR 1PH/60/115/230	816141-002	169038	6 72807 28449 7
29	SEAL BEARING ASSEMBLY (STD./B.F.)	816032-000	186863	6 72807 28437 4
29	SEAL BEARING ASSEMBLY (A.B.)	816032-000	186864	6 72807 28437 4
2	BRONZE IMPELLER	816302-047	186359	6 72807 28462 6
2	STEEL IMPELLER	816302-017	186441	6 72807 28457 2

56

ITEM NO.	PART DESCRIPTION	PART NUMBER		UPC CODE
		ARMSTRONG	B&G	
2	NORYL IMPELLER	816302-317	N/A	 6 72807 28467 1
8	COUPLER	807436-000	118473	 6 72807 28170 0
28	BODY GASKET	106158-000	P57410	 6 72807 01167 3
4	FLANGE GASKET	805176-000	118368	 6 72807 28116 8
15	SEAL KIT	816706-021	118681	 6 72807 28602 6
1	BRONZE BODY	816337-041	N/A	 6 72807 28519 7
1	CAST IRON BODY	816337-011	186386	 6 72807 28518 0

Armstrong H-53 BF & AB SINGLE PHASE (STANDARD CONSTRUCTION IS BRONZE FITTED)

MODEL NUMBER

ITT / B&G 1 PR

ARMSTRONG H-41 BF & AB

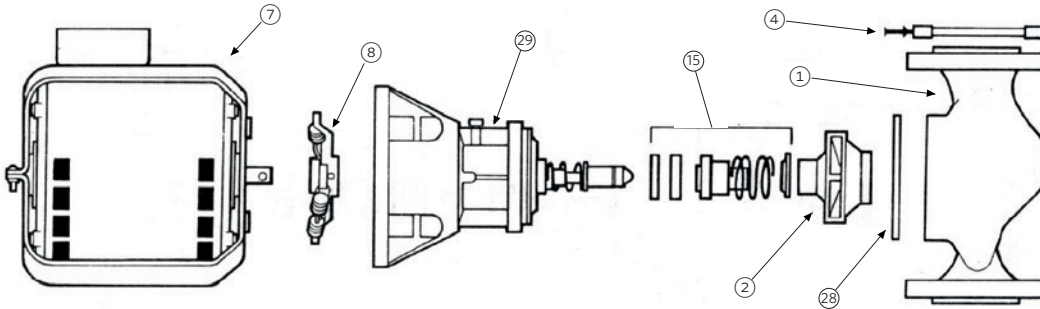

ITEM NO.	PART DESCRIPTION	PART NUMBER		UPC CODE
		ARMSTRONG	B&G	
7	½ HP MOTOR 1PH/60/115/230	811757-001	111044	6 72807 28380 3
7	½ HP MOTOR 3PH/60/208/230/460	831011-083*	111046	6 72807 28744 3
7	½ HP MOTOR 3PH/60/208/230/460	811757-024	111046	N/A
29	SEAL BEARING ASSEMBLY (STD./B.F.)	816032-000	186863	6 72807 28437 4
29	SEAL BEARING ASSEMBLY (A.B.)	816032-000	186864	6 72807 28437 4
2	BRONZE IMPELLER	816303-047	186368	6 72807 28476 3
2	STEEL IMPELLER	816303-017	P61010	6 72807 28472 5
2	NORYL IMPELLER	816303-317	N/A	6 72807 28480 0
8	COUPLER ½" x ⅝"	806137-000	118709	6 72807 28143 4
28	BODY GASKET	106158-000	P57410	6 72807 01167 3

ITEM NO.	PART DESCRIPTION	PART NUMBER		UPC CODE
		ARMSTRONG	B&G	
4	FLANGE GASKET	805176-000	118368	6 72807 28116 8
15	SEAL KIT	816706-021	118681	6 72807 28602 6
1	BRONZE BODY	816337-041	N/A	6 72807 28519 7
1	CAST IRON BODY	816337-011	186386	6 72807 28518 0

Armstrong H-54 BF & AB (STANDARD CONSTRUCTION IS BRONZE FITTED)

MODEL NUMBER	ARMSTRONG H-54 BF & AB (STANDARD CONSTRUCTION IS BRONZE FITTED)
ITT / B&G 60-4 (OLD), 60-14(NEW)	

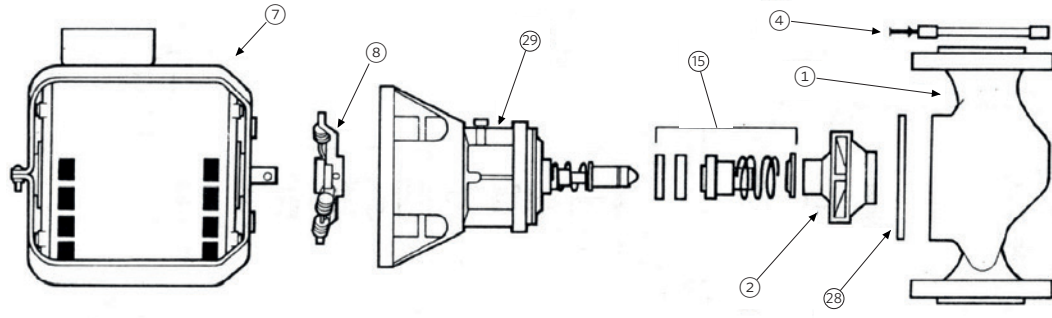

ITEM NO.	PART DESCRIPTION	PART NUMBER		UPC CODE
		ARMSTRONG	B&G	
7	¾ HP MOTOR 1PH/60/115/230	811757-002	111047	6 72807 28381 0
7	¾ HP MOTOR 3PH/60/208/230/460	831012-083*	111049	6 72807 28745 0
7	¾ HP MOTOR 3PH/60/208/230/460	811757-024	111049	N/A
29	SEAL BEARING ASSEMBLY (STD./B.F.)	816032-000	186863	6 72807 28437 4

ITEM NO.	PART DESCRIPTION	PART NUMBER		UPC CODE
		ARMSTRONG	B&G	
29	SEAL BEARING ASSEMBLY (A.B.)	816032-000	186864	6 72807 28437 4
2	BRONZE IMPELLER	816304-047	118626	6 72807 28487 9
2	STEEL IMPELLER	816304-017	118629	6 72807 28484 8
8	NORYL IMPELLER	816304-317	N/A	6 72807 28490 9
8	COUPLER 1/2" x 5/8"	806137-000	118709	6 72807 28143 4
28	BODY GASKET	106158-000	P57410	6 72807 01167 3
4	FLANGE GASKET	816117-000	118378	6 72807 28445 9
15	SEAL KIT	816706-021	118681	6 72807 28602 6
1	BRONZE BODY	816338-041	P57200	6 72807 28521 0
1	CAST IRON BODY	816338-011	186392	6 72807 28520 3

NOTE: *Rigid Mount Ball Bearing Motor can be supplied or the Resilient Mount Motor.

60

CIRCULATOR PARTS

MODEL NUMBER

ITT / B&G PD-39 (MFTD. PRIOR TO 10/77, DATE CODED KU)

ARMSTRONG - NO EQUIVALENT

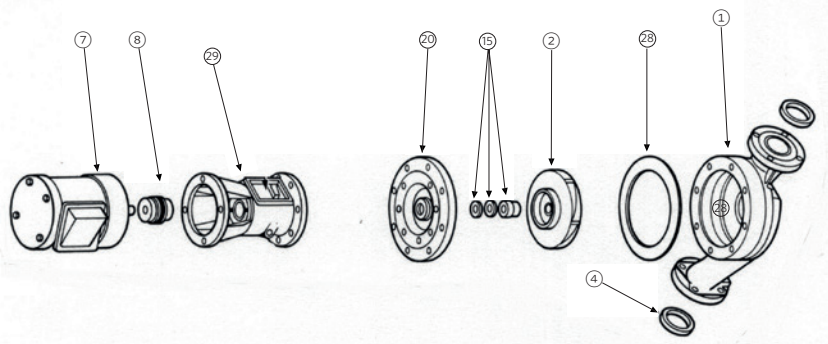

ITEM NO.	PART DESCRIPTION	PART NUMBER		UPC CODE
		ARMSTRONG	B&G	
7	1HP MOTOR 1PH/60/115/230	811757-007	111050	
7	1HP MOTOR 3PH/60/208/230/460	811757-028	111051	N/A
29	SEAL BEARING ASSEMBLY (STD./B.F.)	816133-000**	185232	
29	SEAL BEARING ASSEMBLY (A.B.)	816134-000**	185234	
2	BRONZE IMPELLER	816311-041	118453	
2	STEEL IMPELLER	N/A	N/A	N/A
2	COUPLER 5/8" x 1/2"	812734-000	186410	
8	COUPLER 5/8" x 5/8"	816665-000	118476/P77265	
28	BODY GASKET	106592-000	P57700	



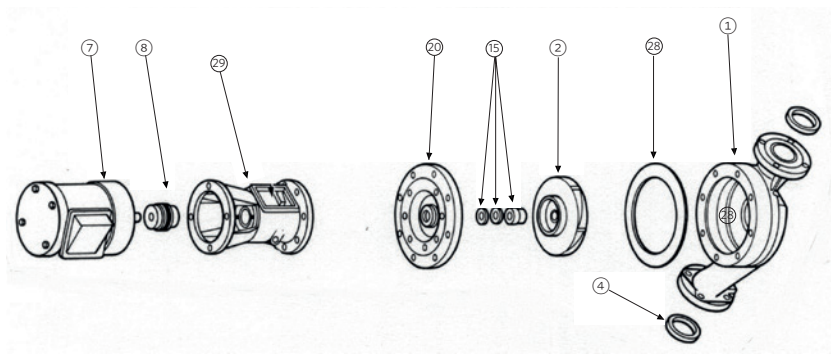

ITEM NO.	PART DESCRIPTION	PART NUMBER		UPC CODE
		ARMSTRONG	B&G	
4	FLANGE GASKET	816117-000	118378	6 72807 28445 9
15	SEAL KIT	816706-021	118681	6 72807 28602 6

CIRCULATOR PARTS

MODEL NUMBER	ARMSTRONG - NO EQUIVALENT (STANDARD CONSTRUCTION IS BRONZE FITTED)
ITT / B&G PD-39 (MFTD. PRIOR TO 10/77 OR AFTER, DATE CODED KU)	



ITEM NO.	PART DESCRIPTION	PART NUMBER		UPC CODE
		ARMSTRONG	B&G	
7	1HP MOTOR 1PH/60/115/230	811757-007	111050	6 72807 28384 1
7	1HP MOTOR 3PH/60/208/230/460	811757-028	111051	N/A
29	SEAL BEARING ASSEMBLY (STD./B.F.)	816133-000**	185260	6 72807 28446 6
29	SEAL BEARING ASSEMBLY (A.B.)	816134-000**	185262	6 72807 28447 3
2	BRONZE IMPELLER	816311-041	118453	6 72807 28511 1

ITEM NO.	PART DESCRIPTION	PART NUMBER		UPC CODE
		ARMSTRONG	B&G	
2	STEEL IMPELLER	N/A	N/A	N/A
2	COUPLER 5/8" x 1/2"	810120-008	186410	 6 72807 28197 7
8	COUPLER 5/8" x 5/8"	816665-000	118476/P77265	 6 72807 28594 4
28	BODY GASKET	106592-000	P57700	 6 72807 01282 3
4	FLANGE GASKET	805201-000	118129	 6 72807 28122 9
15	SEAL KIT	810120-009	186499	 6 72807 28198 4

CIRCULATOR PARTS

MODEL NUMBER

ITT / B&G 60-5 (OLD), 60-15 (NEW)
(MFTD. PRIOR TO 10/77 OR AFTER, DATE CODED KU)

ARMSTRONG - NO EQUIVALENT
(STANDARD CONSTRUCTION IS BRONZE FITTED)

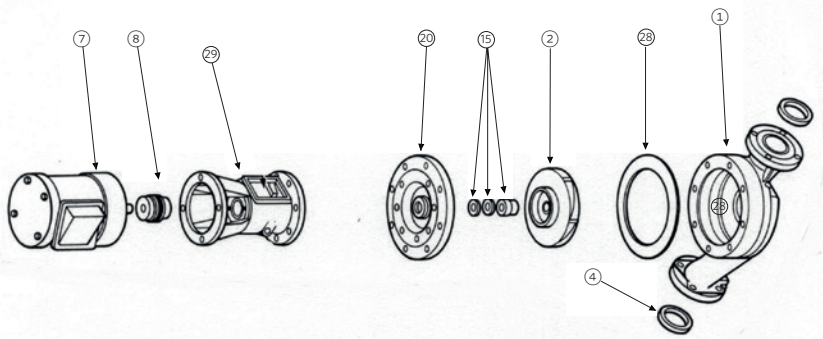

ITEM NO.	PART DESCRIPTION	PART NUMBER		UPC CODE
		ARMSTRONG	B&G	
7	½ HP MOTOR 1PH/60/115/230	811757-001	111044	
7	½ HP MOTOR 3PH/60/208/230/460	811757-020	111046	N/A
29	SEAL BEARING ASSEMBLY (STD./B.F.)	816133-000**	185232	
29	SEAL BEARING ASSEMBLY (A.B.)	816134-000**	185234	
2	BRONZE IMPELLER	816309-041	P57445	
2	STEEL IMPELLER	N/A	N/A	N/A
2	COUPLER ⅝" × ½"	810120-008	186410	
8	COUPLER ⅝" × ⅝"	816665-000	118476/P77265	
28	BODY GASKET	106592-000	P57700	





64

ITEM NO.	PART DESCRIPTION	PART NUMBER		UPC CODE
		ARMSTRONG	B&G	
4	FLANGE GASKET	804034-000	118373	6 72807 28103 8
15	SEAL KIT	810120-009	186499	6 72807 28198 4

CIRCULATOR PARTS

MODEL NUMBER	ARMSTRONG - NO EQUIVALENT (STANDARD CONSTRUCTION IS BRONZE FITTED)
ITT / B&G 60-6 (OLD), 60-16 (NEW) (MFTD. PRIOR TO 10/77, DATE CODED KU)	

ITEM NO.	PART DESCRIPTION	PART NUMBER		UPC CODE
		ARMSTRONG	B&G	
7	3/4 HP MOTOR 1PH/60/115/230	811757-002	111047	6 72807 28381 0
7	3/4 HP MOTOR 3PH/60/208/230/460	811757-024	111049	N/A
29	SEAL BEARING ASSEMBLY (STD./B.F.)	816133-000**	185232	6 72807 28446 6
29	SEAL BEARING ASSEMBLY (A.B.)	816134-000**	185234	6 72807 28447 3
2	BRONZE IMPELLER	816309-041	P57445	6 72807 28509 8

ITEM NO.	PART DESCRIPTION	PART NUMBER		UPC CODE
		ARMSTRONG	B&G	
2	STEEL IMPELLER	N/A	N/A	N/A
2	COUPLER 5/8" x 1/2"	810120-008	186410	 6 72807 28197 7
8	COUPLER 5/8" x 5/8"	816665-000	118476/P77265	 6 72807 28594 4
28	BODY GASKET	106592-000	P57700	 6 72807 01282 3
4	FLANGE GASKET	804034-000	118373	 6 72807 28103 8
15	SEAL KIT	810120-009	186499	 6 72807 28198 4

CIRCULATOR PARTS

MODEL NUMBER

ITT / B&G 60-9 (OLD), 60-19 (NEW)
 (MFTD. PRIOR TO 10/77, DATE CODED KU)

ARMSTRONG - NO EQUIVALENT
 (STANDARD CONSTRUCTION IS BRONZE FITTED)

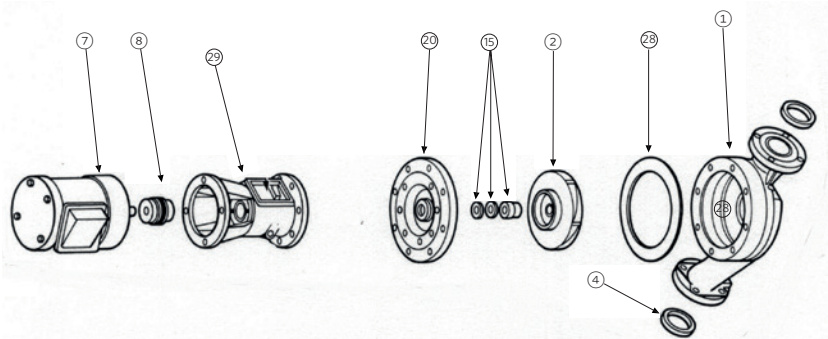

ITEM NO.	PART DESCRIPTION	PART NUMBER		UPC CODE
		ARMSTRONG	B&G	
7	1 HP MOTOR 1PH/60/115/230	811757-007	111050	
7	1 HP MOTOR 3PH/60/208/230/460	811757-028	111051	N/A
29	SEAL BEARING ASSEMBLY (STD./B.F.)	816133-000**	185232	
29	SEAL BEARING ASSEMBLY (A.B.)	816134-000**	185234	
2	BRONZE IMPELLER	816310-041	P57450	
2	STEEL IMPELLER	N/A	N/A	N/A
8	COUPLER 5/8" x 1/2"	810120-008	186410	
8	COUPLER 5/8" x 5/8"	816665-000	118476/P77265	
28	BODY GASKET	106592-000	P57700	

ITEM NO.	PART DESCRIPTION	PART NUMBER		UPC CODE
		ARMSTRONG	B&G	
4	FLANGE GASKET	816117-000	118378	6 72807 28445 9
15	SEAL KIT	810120-009	186499	6 72807 28198 4

CIRCULATOR PARTS

MODEL NUMBER

ITT / B&G 60-7 (OLD), 60-17 (NEW)
(MFTD. PRIOR TO 10/77, DATE CODED KU)

ARMSTRONG - NO EQUIVALENT
(STANDARD CONSTRUCTION IS BRONZE FITTED)

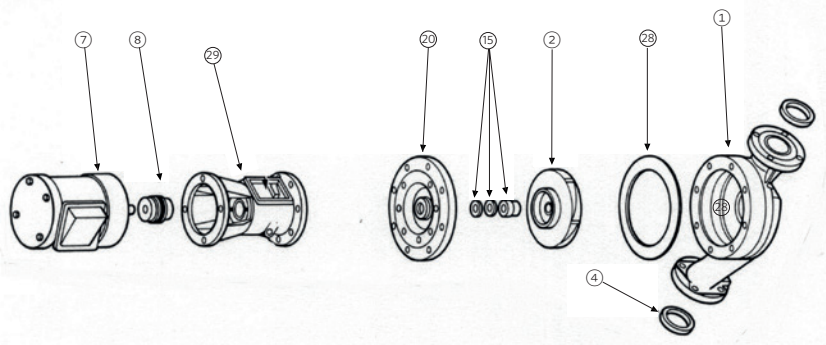

ITEM NO.	PART DESCRIPTION	PART NUMBER		UPC CODE
		ARMSTRONG	B&G	
7	1 HP MOTOR 1PH/60/115/230	811757-007	111050	6 72807 28384 1
7	1 HP MOTOR 3PH/60/208/230/460	811757-028	111051	N/A
29	SEAL BEARING ASSEMBLY (STD./B.F.)	816133-000**	185232	6 72807 28446 6
29	SEAL BEARING ASSEMBLY (A.B.)	816134-000**	185234	6 72807 28447 3
2	BRONZE IMPELLER	816309-041	P57445	6 72807 28509 8
2	STEEL IMPELLER	N/A	N/A	N/A

ITEM NO.	PART DESCRIPTION	PART NUMBER		UPC CODE
		ARMSTRONG	B&G	
8	COUPLER 5/8" x 1/2"	810120-008	186410	6 72807 28197 7
8	COUPLER 5/8" x 5/8"	816665-000	118476/P77265	6 72807 28594 4
28	BODY GASKET	106592-000	P57700	6 72807 01282 3
4	FLANGE GASKET	804034-000	118373	6 72807 28103 8
15	SEAL KIT	810120-009	186499	6 72807 28198 4

CIRCULATOR PARTS

MODEL NUMBER

ITT / B&G 60-10 (OLD), 60-20 (NEW)
 (MFTD. PRIOR TO 10/77, DATE CODED KU)

ARMSTRONG - NO EQUIVALENT
 (STANDARD CONSTRUCTION IS BRONZE FITTED)

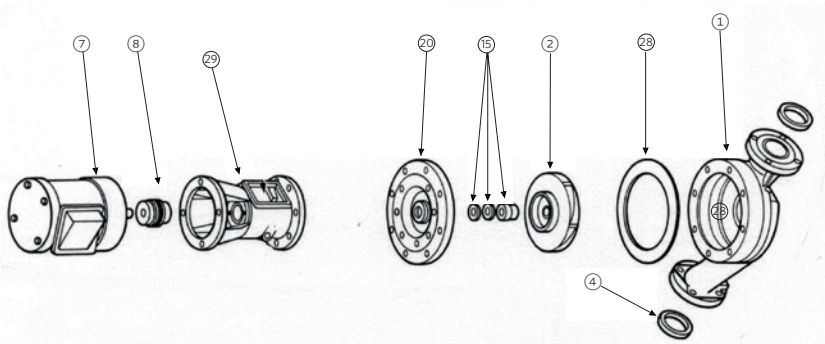

ITEM NO.	PART DESCRIPTION	PART NUMBER		UPC CODE
		ARMSTRONG	B&G	
7	1 1/2 HP MOTOR 1PH/60/115/230	816678-062	169005	6 72807 28597 5
7	1 1/2 HP MOTOR 3PH/60/208/230/460	816678-069	169091/169092	6 72807 28598 2
29	SEAL BEARING ASSEMBLY (STD./B.F.)	816133-000**	185232	6 72807 28446 6

ITEM NO.	PART DESCRIPTION	PART NUMBER		UPC CODE
		ARMSTRONG	B&G	
29	SEAL BEARING ASSEMBLY (A.B.)	816134-000**	185234	 6 72807 28447 3
2	BRONZE IMPELLER	816310-041	P57450	 6 72807 28510 4
2	STEEL IMPELLER	N/A	N/A	N/A
2	COUPLER 5/8" x 1/2"	810120-008	186410	 6 72807 28197 7
8	COUPLER 5/8" x 5/8"	816665-000	118476/P77265	 6 72807 28594 4
28	BODY GASKET	106592-000	P57700	 6 72807 01282 3
4	FLANGE GASKET	804034-000	118373	 6 72807 28103 8
15	SEAL KIT	810120-009	186499	 6 72807 28198 4

70





CIRCULATOR PARTS

MODEL NUMBER

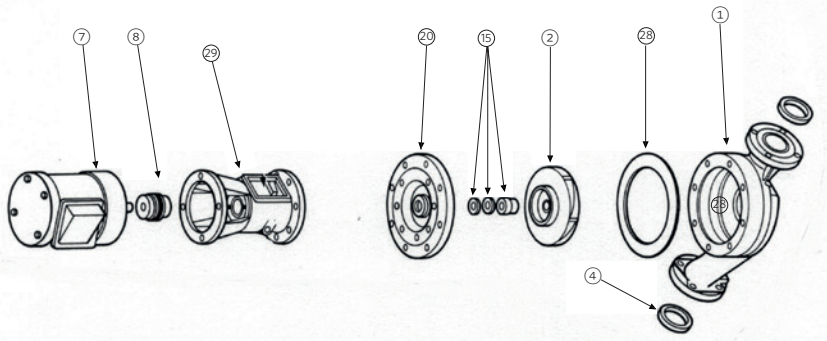
ITT / B&G 60-6 (OLD), 60-16 (NEW)
(MFTD. PRIOR TO 10/77 OR AFTER, DATE CODED KU)

ARMSTRONG - NO EQUIVALENT
(STANDARD CONSTRUCTION IS BRONZE FITTED)



ITEM NO.	PART DESCRIPTION	PART NUMBER		UPC CODE
		ARMSTRONG	B&G	
7	¾ HP MOTOR 1PH/60/115/230	811757-002	111047	 6 72807 28381 0
7	¾ HP MOTOR 3PH/60/208/230/460	811757-024	111049	N/A
29	SEAL BEARING ASSEMBLY (STD./B.F.)	816133-000**	185260	 6 72807 28446 6
29	SEAL BEARING ASSEMBLY (A.B.)	816134-000**	185262	 6 72807 28447 3
2	BRONZE IMPELLER	816309-041	P57445	 6 72807 28509 8
2	STEEL IMPELLER	N/A	N/A	N/A
8	COUPLER ⅝" x ½"	810120-008	186410	 6 72807 28197 7
8	COUPLER ⅝" x ⅝"	816665-000	118476/P77265	 6 72807 28594 4
28	BODY GASKET	106592-000	P57700	 6 72807 01282 3

ITEM NO.	PART DESCRIPTION	PART NUMBER		UPC CODE
		ARMSTRONG	B&G	
4	FLANGE GASKET	804034-000	118373	6 72807 28103 8
15	SEAL KIT	810120-009	186499	6 72807 28198 4

CIRCULATOR PARTS

MODEL NUMBER
ITT / B&G 60-7 (OLD), 60-17 (NEW) (MFTD. PRIOR TO 10/77 OR AFTER, DATE CODED KU)
ARMSTRONG - NO EQUIVALENT (STANDARD CONSTRUCTION IS BRONZE FITTED)

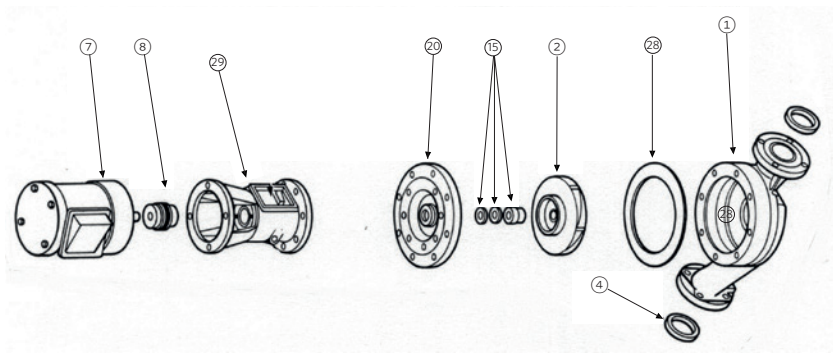

ITEM NO.	PART DESCRIPTION	PART NUMBER		UPC CODE
		ARMSTRONG	B&G	
7	1 HP MOTOR 1PH/60/115/230	811757-007	111050	6 72807 28384 1
7	1 HP MOTOR 3PH/60/208/230/460	811757-028	111051	N/A
29	SEAL BEARING ASSEMBLY (STD./B.F.)	816133-000**	185260	6 72807 28446 6
29	SEAL BEARING ASSEMBLY (A.B.)	816134-000**	185262	6 72807 28447 3
2	BRONZE IMPELLER	816309-041	P57445	6 72807 28509 8
2	STEEL IMPELLER	N/A	N/A	N/A

ITEM NO.	PART DESCRIPTION	PART NUMBER		UPC CODE
		ARMSTRONG	B&G	
8	COUPLER 5/8" x 1/2"	810120-008	186410	6 72807 28197 7
8	COUPLER 5/8" x 5/8"	816665-000	118476/P77265	6 72807 28594 4
28	BODY GASKET	106592-000	P57700	6 72807 01282 3
4	FLANGE GASKET	804034-000	118373	6 72807 28103 8
15	SEAL KIT	810120-009	186499	6 72807 28198 4

CIRCULATOR PARTS





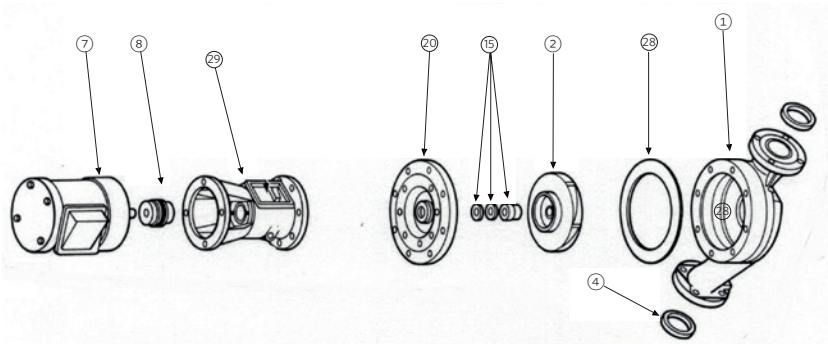

MODEL NUMBER

ITT / B&G 60-9 (OLD), 60-19 (NEW)
 (MFTD. PRIOR TO 10/77 OR AFTER, DATE CODED KU)

ARMSTRONG - NO EQUIVALENT
 (STANDARD CONSTRUCTION IS BRONZE FITTED)



ITEM NO.	PART DESCRIPTION	PART NUMBER		UPC CODE
		ARMSTRONG	B&G	
7	1 HP MOTOR 1PH/60/115/230	811757-007	111050	6 72807 28384 1
7	1 HP MOTOR 3PH/60/208/230/460	811757-028	111051	N/A
29	SEAL BEARING ASSEMBLY (STD./B.F.)	816133-000**	185260	6 72807 28446 6

ITEM NO.	PART DESCRIPTION	PART NUMBER		UPC CODE
		ARMSTRONG	B&G	
29	SEAL BEARING ASSEMBLY (A.B.)	816134-000**	185262	 6 72807 28447 3
2	BRONZE IMPELLER	816310-041	P57450	 6 72807 28510 4
2	STEEL IMPELLER	N/A	N/A	N/A
2	COUPLER 5/8" x 1/2"	810120-008	186410	 6 72807 28197 7
8	COUPLER 5/8" x 5/8"	816665-000	118476/P77265	 6 72807 28594 4
28	BODY GASKET	106592-000	P57700	 6 72807 01282 3
4	FLANGE GASKET	816117-000	118378	 6 72807 28445 9
15	SEAL KIT	810120-009	186499	 6 72807 28198 4

CIRCULATOR PARTS



MODEL NUMBER

ITT / B&G 60-10 (OLD), 60-20 (NEW)
 (MFTD. PRIOR TO 10/77 OR AFTER, DATE CODED KU)

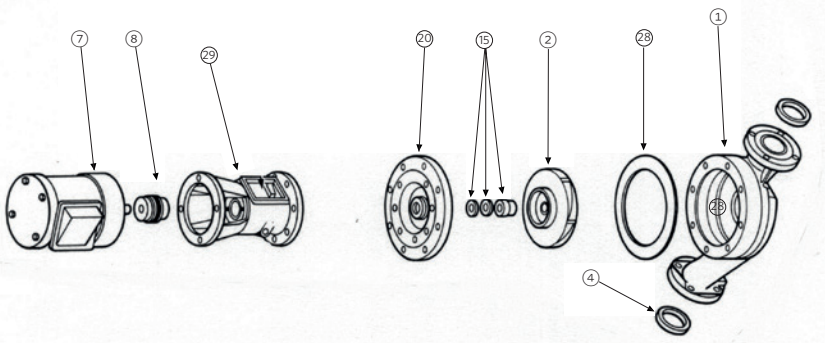



ARMSTRONG - NO EQUIVALENT
 (STANDARD CONSTRUCTION IS BRONZE FITTED)



ITEM NO.	PART DESCRIPTION	PART NUMBER		UPC CODE
		ARMSTRONG	B&G	
7	1 1/2 HP MOTOR 1PH/60/115/230	816678-062	169005	6 72807 28597 5
7	1 1/2 HP MOTOR 3PH/60/208/230/460	816678-069	169091/169092 111052	6 72807 28598 2
29	SEAL BEARING ASSEMBLY (STD./B.F.)	816133-000**	185260	6 72807 28446 6
29	SEAL BEARING ASSEMBLY (A.B.)	816134-000**	185262	6 72807 28447 3
2	BRONZE IMPELLER	816310-041	P57450	6 72807 28510 4
2	STEEL IMPELLER	N/A	N/A	N/A
8	COUPLER 5/8" x 1/2"	810120-008	186410	6 72807 28197 7
8	COUPLER 5/8" x 5/8"	816665-000	118476/P77265	6 72807 28594 4
28	BODY GASKET	106592-000	P57700	6 72807 01282 3

ITEM NO.	PART DESCRIPTION	PART NUMBER		UPC CODE
		ARMSTRONG	B&G	
4	FLANGE GASKET	804034-000	118373	 6 72807 28103 8
15	SEAL KIT	810120-009	186499	 6 72807 28198 4

FOR B&G PUMPS ONLY

DESCRIPTION	PART NUMBER		UPC CODE
	ARMSTRONG	B&G	
2" - SBA	811757-007	111050	 6 72807 28384 1
2" - 1/8 HP MOTOR	811757-028	111051	N/A
SBA FOR PD-39, 60-5, 60-6, 60-7, 60-9 & 60-10 60-15, 60-16, 60-17, 60-19 & 60-20	816133-000**	185232	 6 72807 28446 6
SBA FOR PD-39, 60-5, 60-6, 60-7, 60-9 & 60-10 60-15, 60-16, 60-17, 60-19 & 60-20	816134-000**	185234	 6 72807 28447 3
HD3 - 1/3 HP MOTOR	816309-041	P57445	 6 72807 28509 8

NOTE: **Use the B&G Impeller (with pressure balance holes) with these Bearing Assemblies. These Bearing Assemblies include the following Cover Plates and are supplied with part number 817607-001 Seal Kit and Body Gasket:



#20 FOR STD. & B.F.	816347-011
#20 FOR A.B.	816347-041

***Use the B&G Impeller (with pressure balance holes) with these bearing assemblies. These seal bearing assemblies include the 816366-041 bearing assembly, 816707-001 seal kit, and either the 816347-011 STD./B.F. cover plate of the 816347-041 A.B.

FLANGES

CIRCULATORS

CROSS REFERENCE

DIA. NO.	DIMENSION			MATERIAL	PART NUMBER		UPC CODE	MODEL NUMBER	
	NPT	B	C		D	B&G		ARMSTRONG	B&G
1	3/4"	3 5/32"	-	1/2"	C.I.	P00740	816013-011	N/A	75 S-25 - 3/4"
1	3/4"	3 5/32"	-	1/2"	BRONZE	118347	816013-041	N/A	75 S-25 - 3/4"
1	1"	3 5/32"	-	1/2"	C.I.	P01510	816012-011	N/A	100 S-25 - 1"
1	1"	3 5/32"	-	1/2"	BRONZE	118356	816012-041	N/A	100 S-25 - 1"
1	1 1/4"	3 5/32"	-	1/2"	C.I.	P03250	816011-011	N/A	125 S-25 - 1 1/4"
1	1 1/4"	3 5/32"	-	1/2"	BRONZE	P06640	816011-041	N/A	125 S-25 - 1 1/4"
1	1 1/2"	3 5/32"	-	1/2"	C.I.	P03430	816009-011	N/A	150 S-25 - 1 1/2"
1	1 1/2"	3 5/32"	-	1/2"	BRONZE	P03450	816009-041	N/A	150 S-25 - 1 1/2"
1	1 1/2"	3 7/16"	-	1/2"	C.I.	P03410	804301-011	 6 72807 28110 6	1 1/2 HV S-34, H-32
1	1 1/2"	3 7/16"	-	1/2"	BRONZE	P06690	804301-041	 6 72807 28111 3	1 1/2 HV S-34, H-32
2	2"	3 3/4"	4 7/8"	1/16"	C.I.	N/A	805210-011	N/A	N/A S-35
2	2"	3 3/4"	4 7/8"	1/16"	BRONZE	N/A	805210-041	N/A	N/A S-35
2	2 1/2"	5 1/16"	6"	1/16"	C.I.	P03560	805189-011	N/A	2.5 S-45
2	2 1/2"	5 1/16"	6"	1/16"	BRONZE	P06750	805189-041	N/A	2.5 S-45
2	3"	5 1/16"	6"	1/16"	C.I.	F74000	805188-011	 6 72807 28118 2	3LD, 3HD S-45, S-46
2	3"	5 1/16"	6"	1/16"	BRONZE	F74800	805188-041	 6 72807 28119 9	3LD, 3HD S-45, S-46

DIA. NO.	DIMENSION				MATERIAL	PART NUMBER		UPC CODE	MODEL NUMBER	
	NPT	B	C	D		B&G	ARMSTRONG		B&G	ARMSTRONG
2	3"	5 1/16"	6"	1/16"	C.I.	F74000	805188-011		PD35, PD37	S-55, S-57
2	3"	5 1/16"	6"	1/16"	BRONZE	F74800	805188-041		PD35, PD37	S-55, S-57
1	1"	3 3/16"	-	1/2"	C.I.	P01500	806073-011		1" HV	H-32
1	1"	3 7/16"	-	1/2"	BRONZE	P06620	806073-041		1" HV	H-32
1	1 1/4"	3 7/16"	-	1/2"	C.I.	P03300	804300-011		1 1/4" HV	H-32
1	1 1/4"	3 7/16"	-	1/2"	BRONZE	P06660	804300-041		1 1/4" HV	H-32
2	3"	6"	7 1/2"	3/4"	C.I.	A24600	833615-010		PD39	S-69
2	3"	6"	7 1/2"	3/4"	BRONZE	N/A	806466-041	N/A	N/A	S-69
1	1 1/2"	3 5/32"	-	1/2"	C.I.	P03430	816009-011	N/A	60-13	H-53
1	1 1/2"	3 5/32"	-	1/2"	BRONZE	P03450	816009-041	N/A	60-13	H-53
1	1 1/2"	3 7/16"	-	1/2"	C.I.	P03410	804301-011		60-15 TO 60-17	H-63 TO H-65
1	1 1/2"	3 7/16"	-	1/2"	BRONZE	P06690	804301-041		60-15 TO 60-17	H-63 TO H-65

DIA.	DIMENSION				MATERIAL	PART NUMBER		UPC CODE	MODEL NUMBER	
	NO.	NPT	B	C		D	B&G		ARMSTRONG	B&G
2	2"	3 5/32"	5 1/8"	5/8"	C.I.	118066	806074-011	N/A	60-14, 18 TO 21	H-54, H66 TO H68
2	2"	3 5/32"	5 1/8"	5/8"	BRONZE	118097	806074-041	N/A	60-14, 18 TO 21	H-54, H66 TO H68

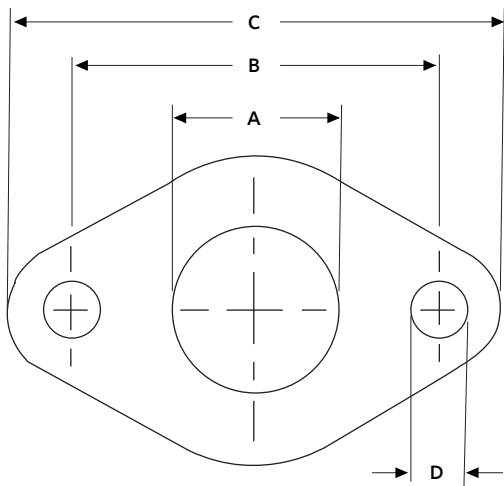

DIAGRAM 1

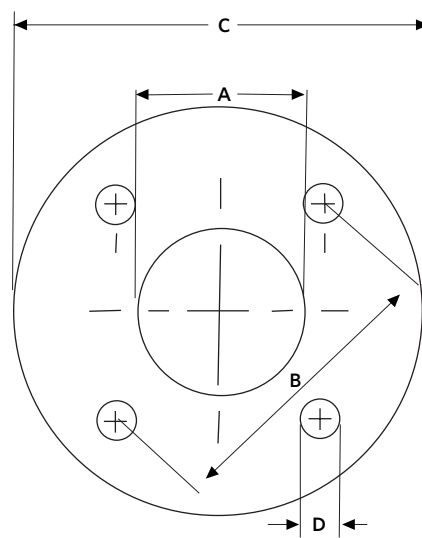

DIAGRAM 2

CROSS REFERENCE Flanges
 Circulators



BASE MOUNTED PUMP PARTS CROSS REFERENCE

Armstrong model 4030 bearing frames, all speeds

MODEL NUMBER	
B&G MODEL 1510	ARMSTRONG MODEL 4030 BEARING FRAMES, ALL SPEEDS

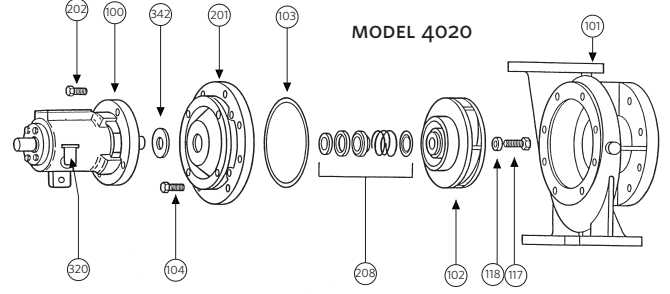
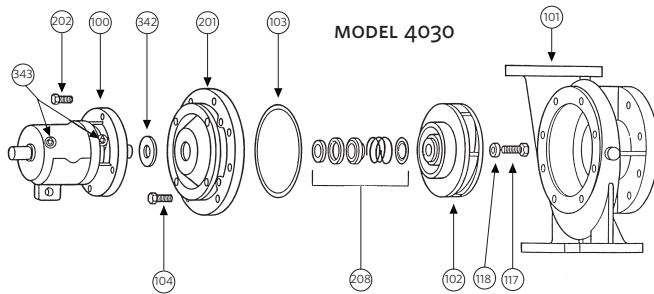

MOTOR HP AND MOTOR SPEED	1200RPM	½	¾	1	1 ½	2	3	5	7 ½	10	-	-	15	20	-	-	25	30	-
	1800RPM	¾	1	1 ½ & 2	3	5	7 ½	10	15	20	-	-	25	30	-	-	40	50	-
	3600RPM	-	-	-	5	7 ½	10	15	20	25	30	40	-	-	50	60	-	-	75
FRAME SIZE	1954 RERATE	56	182	184	213	215	254U	256U	284U	286U	324S	326S	324U	326U	364US	365US	364U	365U	404US
	1964 RERATE	56	143T	145T	182T	184T	213T	215T	254T	256T	284TS	286TS	284T	286T	324TS	326TS	324T	326T	364TS

PUMP SIZE

B&G	ARMSTRONG																		
1 ¼A	1 ¼D	S	S	S	S	S	S	S	-	-	-	-	-	-	-	-	-	-	-
1 ½A	1 ½D	S	S	S	S	S	S	S	M	M	-	-	-	-	-	-	-	-	-
2A	2D	S	S	S	S	S	S	S	M	M	-	-	-	-	-	-	-	-	-
2 ½A	2 ½D	S	S	S	S	S	S	S	M	M	M	M	-	-	-	-	-	-	-
3A	3D	-	S	S	S	S	S	S	M	M	M	M	-	-	-	-	-	-	-
4A	4D	-	S	S	S	S	S	S	M	M	M	M	-	-	-	-	-	-	-
1 ¼BB	1 ¼E	-	S	S	S	S	S	S	M	M	M	M	-	-	-	-	-	-	-
1 ½BB	1 ½E	-	S	S	S	S	S	S	M	M	M	M	-	-	-	-	-	-	-
2BB	2E	-	S	S	S	S	S	S	M	M	M	M	-	-	M	M	-	-	-
2 ½B	2 ½E	-	-	-	S	S	S	S	-	-	-	-	-	-	-	-	-	-	-
3BB	3E	-	-	-	S	S	S	S	M	-	-	-	-	-	-	-	-	-	-
4BB	4E	-	-	-	-	S	S	S	M	M	-	-	-	-	-	-	-	-	-
5BB	5E	-	-	-	-	-	S	S	M	M	-	M	-	-	-	-	-	-	-
6BB	6E	-	-	-	-	-	-	-	M	M	-	M	-	-	-	-	-	-	-
2C	2G	-	-	-	-	M	M	M	-	-	-	-	-	-	-	-	-	-	-
3C	3G	-	-	-	-	-	M	M	M	M	-	-	-	-	-	-	-	-	-
4C	4G	-	-	-	-	-	-	M	M	M	-	-	M	M	-	-	-	-	-
6C	6G	-	-	-	-	-	-	-	-	M	-	-	M	M	-	-	M	M	M

Armstrong model 4020 bearing frames, 1750 RPM

MODEL NUMBER

B&G MODEL UNIVERSAL

ARMSTRONG MODEL 4020 BEARING FRAMES, 1750 RPM

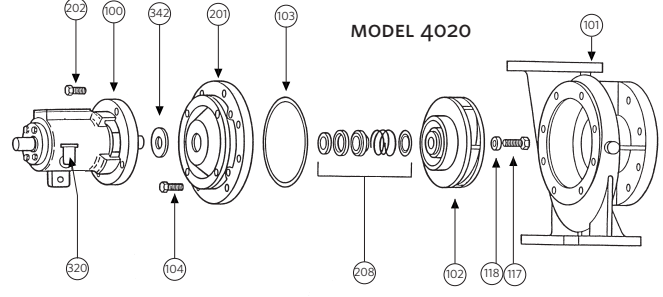
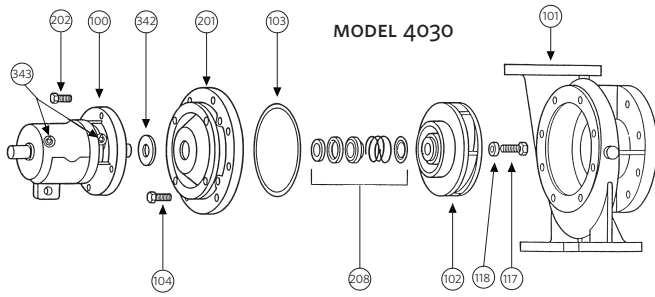

MOTOR HP AND MOTOR SPEED	1750RPM	½ & ¾	1	1 ½ & 2	3	5	7 ½	10	15
FRAME SIZE	1954 RERATE	56	182	184	213	215	254U	256U	284U
	1964 RERATE	56	143T	145T	182T	184T	213T	215T	254T

PUMP SIZE

B&G	ARMSTRONG								
U1 ¼A	1 ¼D	S	S	S	-	-	-	-	-
U1 ½A	1 ½D	S	S	S	-	-	-	-	-
U2A	2D	S	S	S	-	-	-	-	-
U2 ½A	2 ½D	S	S	S	S	-	-	-	-
U3A	3D	-	S	S	S	-	-	-	-
U4A	4D	-	-	S	S	S	-	-	-
U1¼B	1¼E	-	S	S	S	S	-	-	-
U1½B	1½E	-	-	S	S	S	-	-	-
U2B	2E	-	-	S	-	S	S	-	-
U2 ½B	2½E	-	-	-	-	S	S	S	-
U3B	3E	-	-	-	-	S	S	S	-
U4B	4E	-	-	-	-	S	S	S	S
U5B	5E	-	-	-	-	-	S	S	S

NOTE: s" Designation - 7/8" impeller bore, 1 ¼" mechanical seal
 When replacing the bearing frame assemblies on pumps
 Having these motor frame sizes, use the 1510/4030 bearing frame assembly. Part number 819359-002

Item 101 volute

MODEL NUMBER

**B&G MODEL 1510B
B&G UNIVERSAL**

**ARMSTRONG MODEL 4030
ARMSTRONG MODEL 4030**

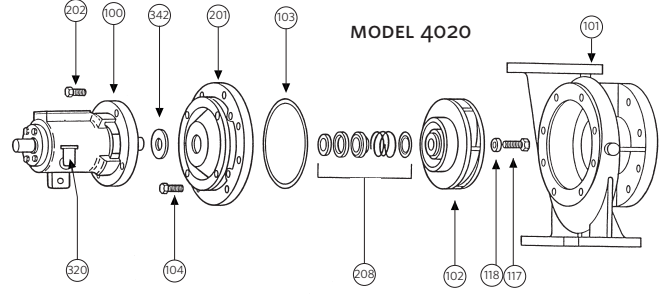
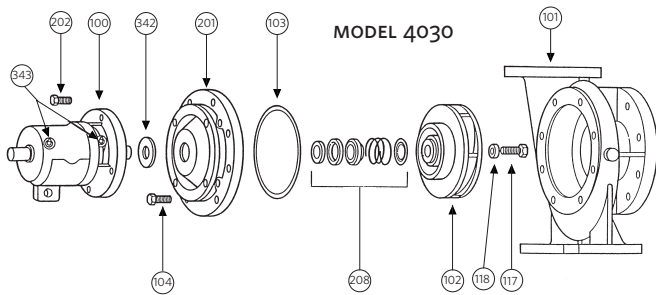

PUMP SIZE		MATERIAL	PART NUMBER		UPC NUMBER
B&G	ARMSTRONG		B&G	ARMSTRONG	
1 ¼AB & U1 ¼A	1 ¼D	CAST IRON	P41240**	415291-011	6 72807 05317 8
1 ¼AB & U1 ¼A	1 ¼D		BRONZE	P41260**	415291-041
1 ½AB & U1 ½A	1 ½D	CAST IRON	P41690	415293-011	6 72807 05325 3
1 ½AB & U1 ½A	1 ½D		BRONZE	P41710	415293-041
2AB & U2A	2D	CAST IRON	P42070**	425141-011	6 72807 05617 9
2AB & U2A	2D		BRONZE	P42090**	425141-041
2 ½A & U2 ½A	2 ½D	CAST IRON	P42360**	425143-011	6 72807 05625 4
3A & U3A***	3D		CAST IRON	PW-121CI**	425145-011
3A & U3A***	3D	BRONZE	PWB-121**	425145-041	N/A

PUMP SIZE		MATERIAL	PART NUMBER		UPC NUMBER
B&G	ARMSTRONG		B&G	ARMSTRONG	
4AB & U4A	4D	CAST IRON	P43250**	415299-011	 6 72807 05342 0
4AB & U4A	4D	BRONZE	P55280**	415299-041	 6 72807 05344 4
U1 ¼B & 1 ¼BB	1 ¼E	CAST IRON	P41410**	416168-011	 6 72807 05374 1
U1 ¼B & 1 ¼BB	1 ¼E	BRONZE	P41430**	416168-041	 6 72807 05376 5
U1 ½B & 1 ½BB	1 ½E	CAST IRON	P41780	425147-011	 6 72807 05644 5
U2B & 2BB	2E	CAST IRON	P14120**	419153-011	 6 72807 05416 8
U2B & 2BB	2E	BRONZE	P42160**	419153-041	N/A
U2 ½B & 2 ½B	2 ½E	CAST IRON	P42480	415297-011	 6 72807 05334 5
U2 ½B & 2 ½B	2 ½E	BRONZE	P55190**	415297-041	 6 72807 05336 9
U3B & 3BB	3E	CAST IRON	P42740	416180-011	 6 72807 05382 6
U3B & 3BB	3E	BRONZE	P42770	416180-041	 6 72807 05384 0
U4B & 4BB	4E	CAST IRON	P43310**	415301-011	 6 72807 05350 5
U4B & 4BB	4E	BRONZE	P55320**	415301-041	N/A
U5B & 5BB	5E	CAST IRON	P43620**	415303-011	 6 72807 05354 3

PUMP SIZE		MATERIAL	PART NUMBER		UPC NUMBER
B&G	ARMSTRONG		B&G	ARMSTRONG	
U5B & 5BB	5E	BRONZE	P55360**	415303-041	 6 72807 05355 0
U6B & 6BB	6E	CAST IRON	P43730**	416188-011	 6 72807 05388 8
2C	2G	CAST IRON	P42865	419544-011	 6 72807 05574 5
2C	2G	BRONZE	-	419544-041	N/A
3C	3G	CAST IRON	P42880	419003-011	 6 72807 05397 0
3C	3G	BRONZE	-	419003-041	N/A
4C	4G	BRONZE	-	419004-041	N/A
6C	6G	CAST IRON	P43810	419542-011	 6 72807 05566 0
6C	6G	BRONZE	-	419542-041	N/A

NOTE: ** These Volutes are no longer available from B&G. "STOCK AT ARMSTRONG"

***For Pumps built prior to 1964 (Serial No. DD) only, use only with Impeller Part numbers 411868-011 & 411868-041 (7/8" Bore) and 419234-011 & 419234-041 (1 1/4" Bore).

Item 201 Impeller 7/8" bore

MODEL NUMBER

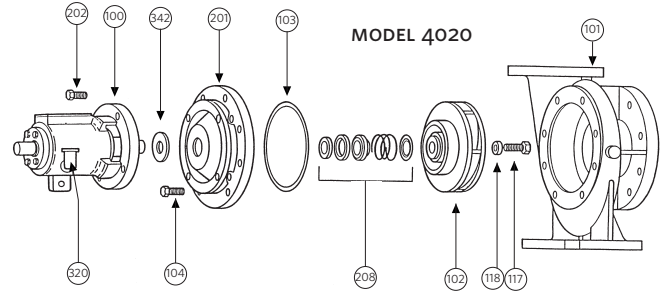
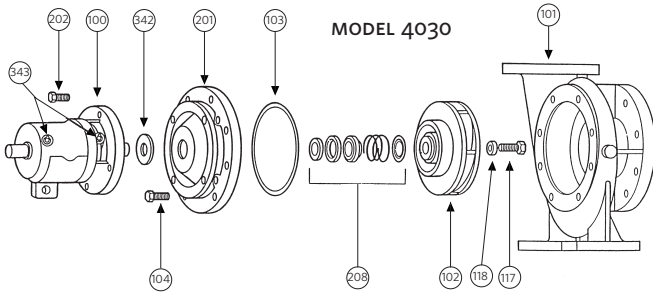

B&G MODEL 1510B

ARMSTRONG MODEL 4030







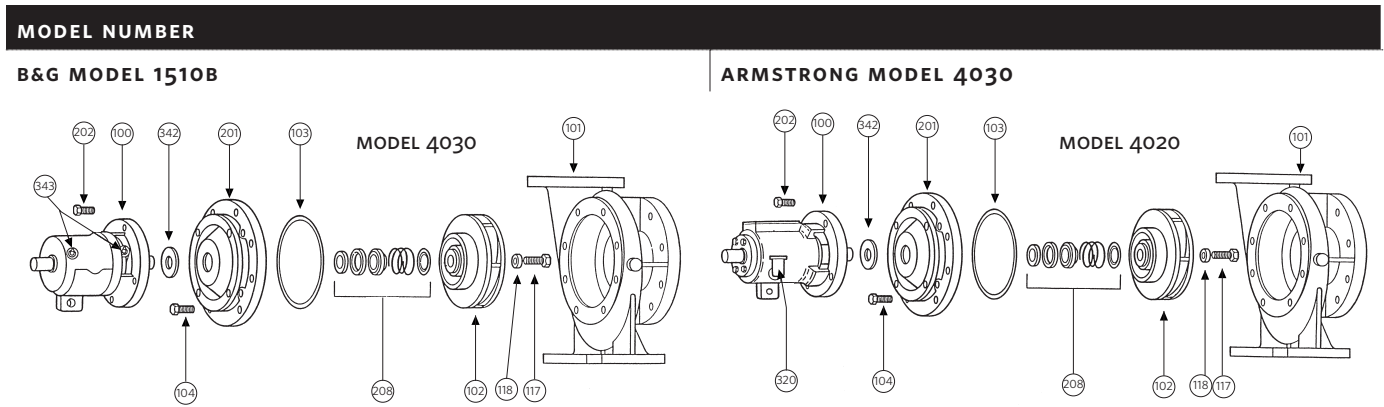

PUMP SIZE		MATERIAL	PART NUMBER		IMPELLER BORE	MAX. DIA.	UPC NUMBER
B&G	ARMSTRONG		B&G	ARMSTRONG			
1 ¼ AB	1 ¼ D	BRONZE	P46630	411852-041	7/8"	7"	6 72807 05243 0
1 ¼ AB	1 ¼ D	CAST IRON	P46510	411852-011	7/8"	7"	6 72807 05241 6
1 ½ AB	1 ½ D	BRONZE	P47950	411860-041	7/8"	7"	6 72807 05247 8
1 ½ AB	1 ½ D	CAST IRON	P47810	411860-011	7/8"	7"	6 72807 05245 4
2 AB	2D	BRONZE	P47950	411860-041	7/8"	7"	6 72807 05247 8
2 AB	2D	CAST IRON	P47810	411860-011	7/8"	7"	6 72807 05245 4
2 ½A	2 ½D	BRONZE	P48770	406642-041	7/8"	7"	6 72807 04745 0
2 ½A	2 ½D	CAST IRON	P49000	406642-011	7/8"	7"	6 72807 04743 6
3A***	3D	BRONZE	P49480	411868-041	7/8"	7"	6 72807 05252 2
3A***	3D	CAST IRON	P49500	411868-011	7/8"	7"	6 72807 05250 8

PUMP SIZE		MATERIAL	PART NUMBER		IMPELLER BORE	MAX. DIA.	UPC NUMBER
B&G	ARMSTRONG		B&G	ARMSTRONG			
4 AB	4D	BRONZE	P56140	411874-041	7/8"	7"	
4 AB	4D	CAST IRON	P50270	411874-041	7/8"	7"	
1 1/4 BB	1 1/4 E	BRONZE	P78523	407922-041	7/8"	9 1/2"	
1 1/4 BB	1 1/4 E	CAST IRON	P78253	407922-011	7/8"	9 1/2"	
1 1/2 BB	1 1/2 E	BRONZE	P78523	407922-041	7/8"	9 1/2"	
1 1/2 BB	1 1/2 E	CAST IRON	P78253	407922-011	7/8"	9 1/2"	
2 BB	2 E	BRONZE	P78525	411881-041	7/8"	9 1/2"	
2 BB	2 E	CAST IRON	P78486	411881-011	7/8"	9 1/2"	
2 1/2 B	2 1/2 E	BRONZE	P78525	411881-041	7/8"	9 1/2"	
2 1/2 B	2 1/2 E	CAST IRON	P78486	411881-011	7/8"	9 1/2"	
3 BB	3 E	BRONZE	P49620	419465-041	7/8"	9 1/2"	
3 BB	3 E	CAST IRON	P49600	419465-011	7/8"	9 1/2"	
4 BB	4 E	BRONZE	P50550	411940-041	7/8"	9 1/2"	
4 BB	4 E	CAST IRON	P50390	411940-011	7/8"	9 1/2"	

PUMP SIZE		MATERIAL	PART NUMBER		IMPELLER BORE	MAX. DIA.	UPC NUMBER
B&G	ARMSTRONG		B&G	ARMSTRONG			
5 BB	5 E	BRONZE	P50930	411941-041	7/8"	9 1/2"	 6 72807 05279 9
5 BB	5 E	CAST IRON	P50910	411941-011	7/8"	9 1/2"	 6 72807 05277 5

Item 201 Impeller 1 1/4" bore



PUMP SIZE		MATERIAL	PART NUMBER		IMPELLER BORE	MAX. DIA.	UPC NUMBER
B&G	ARMSTRONG		B&G	ARMSTRONG			
1 1/2 AB	1 1/2 D	BRONZE	P48070	419229-041	1 1/4"	7"	 6 72807 05445 8
1 1/2 AB	1 1/2 D	CAST IRON	P48050	419229-011	1 1/4"	7"	 6 72807 05443 4
2 AB	2 D	BRONZE	P48070	419229-041	1 1/4"	7"	 6 72807 05445 8
2 AB	2 D	CAST IRON	P48050	419229-011	1 1/4"	7"	 6 72807 05443 4
2 1/2 A	2 1/2 D	BRONZE	P49040	419232-041	1 1/4"	7"	 6 72807 05449 6
2 1/2 A	2 1/2 D	CAST IRON	P48980	419232-011	1 1/4"	7"	 6 72807 05447 2

PUMP SIZE		MATERIAL	PART NUMBER		IMPELLER BORE	MAX. DIA.	UPC NUMBER
B&G	ARMSTRONG		B&G	ARMSTRONG			
3A***	3 D	BRONZE	P49480	419234-041	1 1/4"	7"	 6 72807 05453 3
3A***	3 D	CAST IRON	P49500	419234-011	1 1/4"	7"	 6 72807 05451 9
4 AB	4 D	BRONZE	P50310	419236-041	1 1/4"	7"	 6 72807 05457 1
4 AB	4 D	CAST IRON	P50290	419236-011	1 1/4"	7"	 6 72807 05455 7
1 1/4 BB	1 1/4 E	BRONZE	P78251	419238-041	1 1/4"	9 1/2"	 6 72807 05461 8
1 1/4 BB	1 1/4 E	CAST IRON	P78522	419238-011	1 1/4"	9 1/2"	 6 72807 05459 5
1 1/2 BB	1 1/2 E	BRONZE	P78251	419238-041	1 1/4"	9 1/2"	 6 72807 05461 8
1 1/2 BB	1 1/2 E	CAST IRON	P78522	419238-011	1 1/4"	9 1/2"	 6 72807 05459 5
2 BB	2 E	BRONZE	P78525	419239-041	1 1/4"	9 1/2"	 6 72807 05465 6
2 BB	2 E	CAST IRON	P78257	419239-011	1 1/4"	9 1/2"	 6 72807 05463 2
2 1/2 B	2 1/2 E	BRONZE	P78255	419239-041	1 1/4"	9 1/2"	 6 72807 05465 6
2 1/2 B	2 1/2 E	CAST IRON	P78257	419239-011	1 1/4"	9 1/2"	 6 72807 05463 2
3 BB	3 E	BRONZE	P49640	419241-041	1 1/4"	9 1/2"	 6 72807 05469 4

PUMP SIZE		MATERIAL	PART NUMBER		IMPELLER BORE	MAX. DIA.	UPC NUMBER
B&G	ARMSTRONG		B&G	ARMSTRONG			
3 BB	3 E	CAST IRON	P49660	419241-011	1 ¼"	9 ½"	
4 BB	4 E	BRONZE	P50570	419243-041	1 ¼"	9 ½"	
4 BB	4 E	CAST IRON	P50330	419243-011	1 ¼"	9 ½"	
5 BB	5 E	BRONZE	P50970	419245-041	1 ¼"	9 ½"	
5 BB	5 E	CAST IRON	P50950	419245-011	1 ¼"	9 ½"	
6 BB	6 E	BRONZE	P51290	419247-041	1 ¼"	9 ½"	
6 BB	6 E	CAST IRON	P51270	419247-011	1 ¼"	9 ½"	
2 C	2 G	BRONZE	P77497	419543-041	1 ¼"	12 ½"	
2 C	2 G	CAST IRON	P77499	419543-011	1 ¼"	12 ½"	
3 C	3 G	BRONZE	P49700	419008-041	1 ¼"	12 ½"	
3 C	3 G	CAST IRON	P49680	419008-011	1 ¼"	12 ½"	
4 C	4 G	BRONZE	P50450	419009-041	1 ¼"	12 ½"	
4 C	4 G	CAST IRON	P50430	419009-011	1 ¼"	12 ½"	

PUMP SIZE		MATERIAL	PART NUMBER		IMPELLER BORE	MAX. DIA.	UPC NUMBER
B&G	ARMSTRONG		B&G	ARMSTRONG			
6 C**	6 G	BRONZE	P51370	419541-041	1 ¼"	12 ½"	
6 C**	6 G	CAST IRON	P51350	419541-011	1 ¼"	12 ½"	





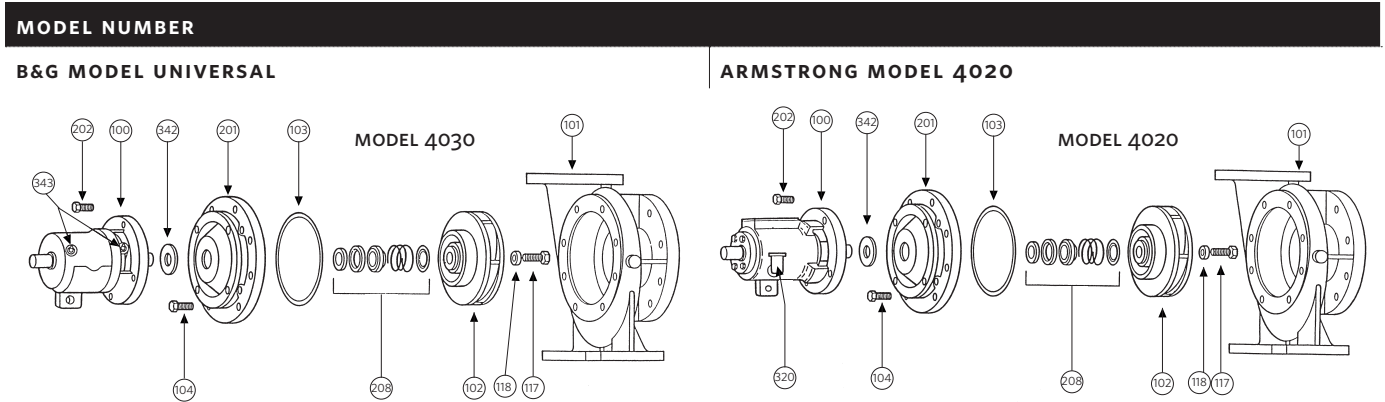



NOTE: ** 6 c & 6G Are mechanically interchangeable, providing both the volute and impeller are of the correct size for the capacity conditions at the same time.
 6 G 4030 has a possible capacity equivalent of a B&G 8 c, depending on the selection of the proper impeller diameter and motor of adequate capacity.
 ***For Pumps built prior to 1964 (Serial No. DD) only, use only with Casing Part Numbers PW-121 for c.i. and PWB-121 for A.B.

Item 201 Impeller 7/8" bore & 1 ¼" bore (Custom sizes)



PUMP SIZE		MATERIAL	PART NUMBER		IMPELLER BORE	MAX. DIA.	UPC NUMBER
B&G	ARMSTRONG		B&G	ARMSTRONG			
U1 ¼ A	1 ¼ D	BRONZE	P46630	411852-041	7/8"	7"	
U1 ¼ A	1 ¼ D	CAST IRON	P46510	411852-011	7/8"	7"	
U1 ½ A	1 ½ D	BRONZE	P47950	411860-041	7/8"	7"	
U1 ½ A	1 ½ D	CAST IRON	P47810	411860-011	7/8"	7"	
U2 A	2 D	BRONZE	P47950	411860-041	7/8"	7"	

PUMP SIZE		MATERIAL	PART NUMBER		IMPELLER BORE	MAX. DIA.	UPC NUMBER
B&G	ARMSTRONG		B&G	ARMSTRONG			
U2 A	2 D	CAST IRON	P47810	411860-011	7/8"	7"	 6 72807 05245 4
U2 1/2 A	2 1/2 D	BRONZE	P48770	406642-041	7/8"	7"	 6 72807 04745 0
U2 1/2 A	2 1/2 D	CAST IRON	P49000	406642-011	7/8"	7"	 6 72807 04743 6
3 A**	3 D	BRONZE	P49480	411868-041	7/8"	7"	 6 72807 05252 2
3 A**	3 D	CAST IRON	P49500	411868-011	7/8"	7"	 6 72807 05250 8
U4 A	4 D	CAST IRON	P50270	411874-041	7/8"	7"	 6 72807 05256 0
U1 1/4 B	1 1/4 E	BRONZE	P78523	407922-041	7/8"	9 1/2"	 6 72807 04793 1
U1 1/4 B	1 1/4 E	CAST IRON	P78253	407922-011	7/8"	9 1/2"	 6 72807 04791 7
U1 1/2 B	1 1/2 E	BRONZE	P78523	407922-041	7/8"	9 1/2"	 6 72807 04793 1
U1 1/2 B	1 1/2 E	CAST IRON	P78253	407922-011	7/8"	9 1/2"	 6 72807 04791 7
U2 B	2 E	BRONZE	P78525	411881-041	7/8"	9 1/2"	 6 72807 05260 7
U2 B	2 E	CAST IRON	P78486	411881-011	7/8"	9 1/2"	 6 72807 05258 4
U2 1/2 B	2 1/2 E	BRONZE	P78525	411881-041	7/8"	9 1/2"	 6 72807 05260 7

PUMP SIZE		MATERIAL	PART NUMBER		IMPELLER BORE	MAX. DIA.	UPC NUMBER
B&G	ARMSTRONG		B&G	ARMSTRONG			
U2 ½ B	2 ½ E	CAST IRON	P78486	411881-011	7/8"	9 ½"	 6 72807 05258 4
U3 B	3 E	BRONZE	P49620	419465-041	7/8"	9 ½"	 6 72807 05550 9
U3 B	3 E	CAST IRON	P49600	419465-011	7/8"	9 ½"	 6 72807 05548 6
U4 B	4 E	BRONZE	P50550	411940-041	7/8"	9 ½"	 6 72807 05275 1
U4 B	4 E	CAST IRON	P50390	411940-011	7/8"	9 ½"	 6 72807 05273 7
U5 B	5 E	BRONZE	P50930	411941-041	7/8"	9 ½"	 6 72807 05279 9
U5 B	5 E	CAST IRON	P50910	411941-011	7/8"	9 ½"	 6 72807 05277 5
U6 B	N/A	BRONZE	P51290	419247-041	1 ¼"	9 ½"	 6 72807 05481 6
U6 B	N/A	CAST IRON	P51270	419247-011	1 ¼"	9 ½"	 6 72807 05479 3

Item 201 Impeller 7/8" bore & 1 1/4" bore (Stock sizes)

MODEL NUMBER



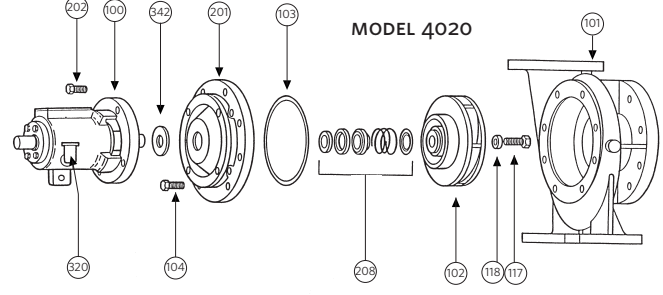
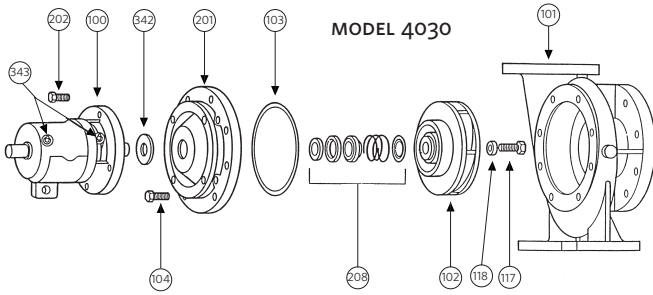

B&G MODEL UNIVERSAL

ARMSTRONG MODEL 4020



PUMP SIZE		MATERIAL	PART NUMBER		IMPELLER BORE	MAX. DIA.	UPC NUMBER
B&G	ARMSTRONG		B&G	ARMSTRONG			
U1T	D 141	BRONZE	P48770	406642-041	7/8"	5 1/4"	6 72807 04745 0
U1T	D 141	CAST IRON	P49000	406642-011	7/8"	5 1/4"	6 72807 04743 6
U2T	D 142	BRONZE	P48770	406642-041	7/8"	6"	6 72807 04745 0
U2T	D 142	CAST IRON	P49000	406642-011	7/8"	6"	6 72807 04743 6
U3T	D 143	BRONZE	P48770	406642-041	7/8"	6 1/2"	6 72807 04745 0
U3T	D 143	CAST IRON	P49000	406642-011	7/8"	6 1/2"	6 72807 04743 6
U4T	D 144	BRONZE	P48770	406642-041	7/8"	6 7/8"	6 72807 04745 0
U4T	D 144	CAST IRON	P49000	406642-011	7/8"	6 7/8"	6 72807 04743 6
U5T	D 145	BRONZE	P78525	411881-041	7/8"	7 1/4"	6 72807 05260 7



PUMP SIZE		MATERIAL	PART NUMBER		IMPELLER BORE	MAX. DIA.	UPC NUMBER
B&G	ARMSTRONG		B&G	ARMSTRONG			
U5T	D 145	CAST IRON	P78486	411881-011	7/8"	7 1/4"	 6 72807 05258 4
U6 T	D 146	BRONZE	P56140	411874-041	7/8"	6 1/2"	 6 72807 05256 0
U6 T	D 146	CAST IRON	P50270	411874-041	7/8"	6 1/2"	 6 72807 05256 0
U7 T	D 147	BRONZE	P78525	411881-041	7/8"	8"	 6 72807 05260 7
U7 T	D 147	CAST IRON	P78486	411881-011	7/8"	8"	 6 72807 05258 4
U8 T	D 148	CAST IRON	P50930	411941-041	7/8"	7 1/4"	 6 72807 05279 9
U8 T	D 148	BRONZE	P50910	411941-011	7/8"	7 1/4"	 6 72807 05277 5
U9 T	1 1/4 D	CAST IRON	P78525	411881-041	7/8"	9"	 6 72807 05260 7
U9 T	1 1/4 D	BRONZE	P78486	411881-011	7/8"	9"	 6 72807 05258 4
U10 T	1 1/2 D	CAST IRON	P50930	411941-041	7/8"	7 1/4"	 6 72807 05279 9
U10 T	1 1/2 D	BRONZE	P50910	411941-011	7/8"	7 1/4"	 6 72807 05277 5
U11 T	2 D	CAST IRON	P50550	411940-041	7/8"	8 3/4"	 6 72807 05275 1
U11 T	2 D	BRONZE	P50390	411940-011	7/8"	8 3/4"	 6 72807 05273 7

PUMP SIZE		MATERIAL	PART NUMBER		IMPELLER BORE	MAX. DIA.	UPC NUMBER
B&G	ARMSTRONG		B&G	ARMSTRONG			
U12 T	2 1/2 D	CAST IRON	P50930	411941-041	7/8"	9 1/2"	 6 72807 05279 9
U12 T	2 1/2 D	CAST IRON	P50910	411941-011	7/8"	9 1/2"	 6 72807 05277 5
U13 OR 14T	N/A	BRONZE	P51290	419247-041	1 1/4"	9 1/2"	 6 72807 05481 6
U13 OR 14T	N/A	CAST IRON	P51270	419247-011	1 1/4"	9 1/2"	 6 72807 05479 3

NOTE: ***For Pumps built prior to 1964 (Serial No. 00) only, use only with Casing Part Numbers PW-121 for c.i. and PWB-121 for A.B.

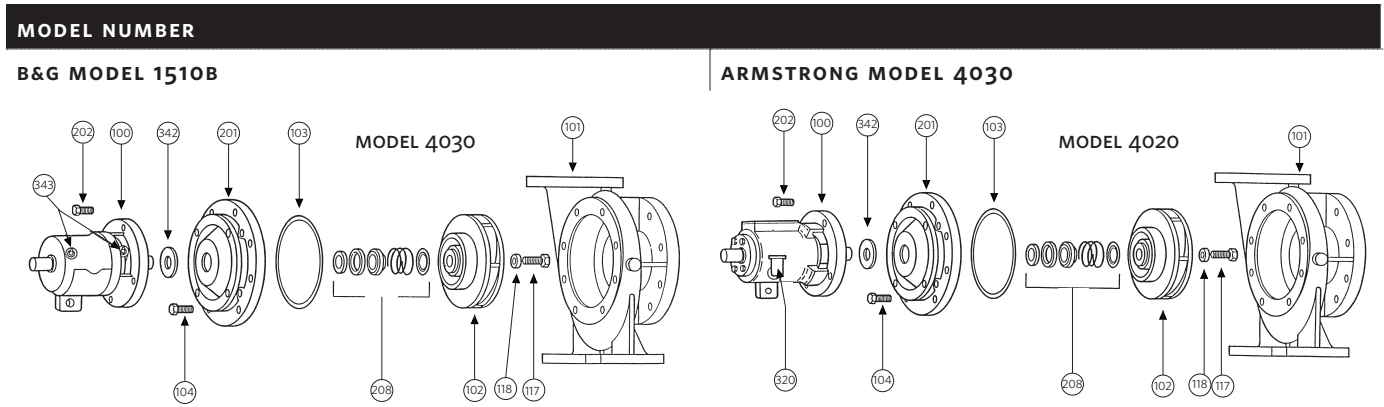
Item 117 Impeller capscrew



PUMP SIZE	PART NUMBER		IMPELLER BORE	CONSTRUCTION	UPC NUMBER
	B&G	ARMSTRONG			
	P52320	911900-108	7/8"	BF-AB	N/A
	P52350	911900-114	7/8"	AB	 6 72807 29208 9
ALL SIZES	P13800	911900-113	1 1/4"	BF-AB	 6 72807 29207 2
	P13800	911900-115	1 1/4"	AB	 6 72807 29209 6

Item 118 Impeller washer

MODEL NUMBER

B&G UNIVERSAL

ARMSTRONG MODEL 4020

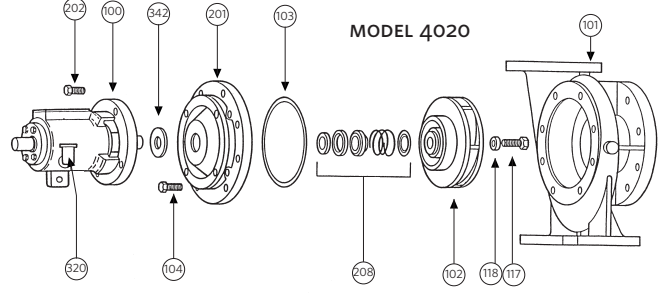
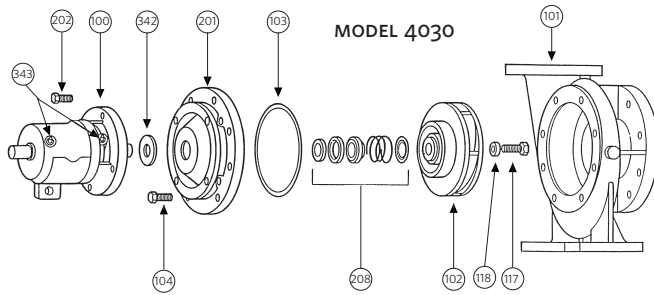

PUMP SIZE	PART NUMBER	IMPELLER BORE	CONSTRUCTION	UPC NUMBER	
	B&G	ARMSTRONG			
	P46390	406614-000	7/8"	BF-A1	N/A
ALL SIZES	P46380	406677-000	7/8"	AB	
	P51250	425742-003	1 1/4"	BF-A1	
	P51230	425742.003	1 1/4"	AB	

Item 100 bearing frame assembly

MODEL NUMBER

B&G MODEL 1510B

ARMSTRONG MODEL 4030

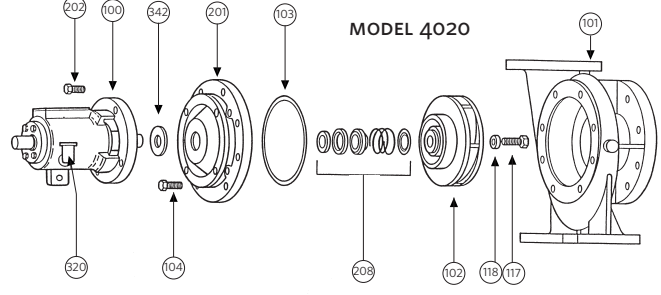
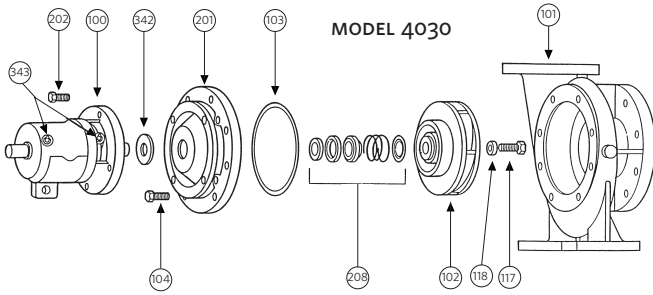

B&G PART NUMBER		ARMSTRONG PART NUMBER	SEAL SIZE	CONSTRUCTION		STYLE	UPC NUMBER
OLD	NEW			B&G	ARMSTRONG		
P77075	185011	819359-002	1 ¼"	BF	BF-AI	BALL BRG.	
P77222	185012	819359-002	1 ¼"	AI	BF-AI	BALL BRG.	
P77226	185013	819360-002	1 ¼"	AB & BFS	AB	BALL BRG.	
P77074	185014	819310-071	1 ⅝"	BF	BF-AI-AB	BALL BRG.	
P77228	185015	819310-071	1 ⅝"	AI	BF-AI-AB	BALL BRG.	





MODEL NUMBER

B&G UNIVERSAL

ARMSTRONG MODEL 4020





B&G PART NUMBER		ARMSTRONG PART NUMBER	SEAL SIZE	CONSTRUCTION		STYLE	UPC NUMBER
OLD	NEW			B&G	ARMSTRONG		
P14770	186660	806617-000	1 ¼"	BF	BF-AI-AB	SLEEVE BRG.	

Item 208 mechanical seal assembly

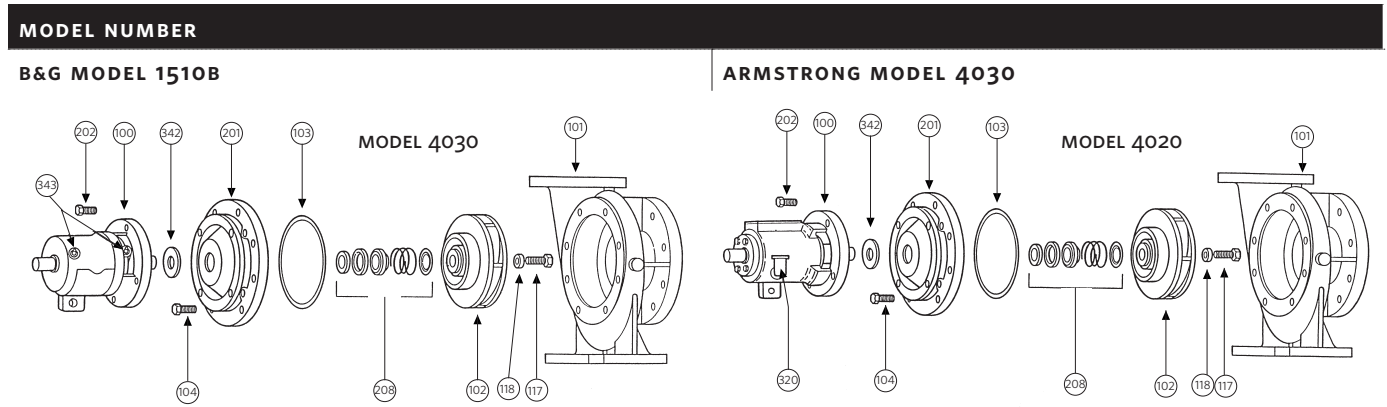



B&G PART NUMBER		ARMSTRONG PART NUMBER	SEAL SIZE	CONSTRUCTION		UPC NUMBER
OLD	NEW			B&G	ARMSTRONG	
#1 KIT	186862	825458-001	1 1/4"	BF-AB	BF-AB-AI	
#4 KIT	186860	825458-001	1 1/4"	AI	BF-AB-AI	
#8 KIT	186543	811339-000	1 5/8"	BF-AB	BF-AB	
#9 KIT	186544	811866-000	1 5/8"	AI	AI	

Item 201 volute coverplate







PUMP SIZE		SEAL SIZE	MATERIAL	PART NUMBER		UPC NUMBER
B&G	ARMSTRONG			B&G	ARMSTRONG	
1 1/4A TO 4AB	1 1/4D TO 4D	1 1/4"	CAST IRON	186482	409564-011	
1 1/4A TO 4AB	1 1/4D TO 4D	1 1/4"	BRONZE	P56779	409564-041	
1 1/4BB TO 5BB	1 1/4E TO 5E	1 1/4"	CAST IRON	186495	409563-011	
1 1/4BB TO 5BB	1 1/4E TO 5E	1 1/4"	BRONZE	P56799	409563-041	

100

PUMP SIZE		SEAL SIZE	MATERIAL	PART NUMBER		UPC NUMBER
B&G	ARMSTRONG			B&G	ARMSTRONG	
3A TO 4AB	2D TO 4D	1 5/8"	CAST IRON	P49940	414498-011	 6 72807 05298 0
3A TO 4AB	2D TO 4D	1 5/8"	BRONZE	P49960	414498-041	 6 72807 05300 0
1 3/4BB TO 6BB	1 3/4E TO 6E	1 5/8"	CAST IRON	P51540	411896-011	 6 72807 05265 2
1 3/4BB TO 6BB	1 3/4E TO 6E	1 5/8"	BRONZE	P51560	411896-041	 6 72807 05269 0
2C TO 8C	2G TO 8G	1 5/8"	CAST IRON	P50670	419467-011	 6 72807 05552 3

Item 103 volute gasket

MODEL NUMBER						
B&G UNIVERSAL				ARMSTRONG MODEL 4020		
PUMP SIZE		SEAL SIZE	CONSTRUCTION	PART NUMBER		UPC NUMBER
B&G	ARMSTRONG			B&G	ARMSTRONG	
1 3/4A TO 4AB	1 3/4D TO 4D	1 3/4"	BF-AI-AB	P57700	106592-000	 6 72807 01282 3
1 3/4BB TO 5BB	1 3/4E TO 5E	AND	BF-AI-AB	P48690	406604-000	 6 72807 04727 6
1 3/4BB TO 6BB	1 3/4E TO 6E		BF-AI-AB	P48690	406604-000	 6 72807 04727 6
2C TO 8C	2G TO 8G	1 5/8"	BF-AI-AB	P57770	419016-000	 6 72807 05410 6

Item 104 volute capscrew

MODEL NUMBER

**B&G MODEL 1510B
B&G UNIVERSAL**

**ARMSTRONG MODEL 4030
ARMSTRONG MODEL 4020**

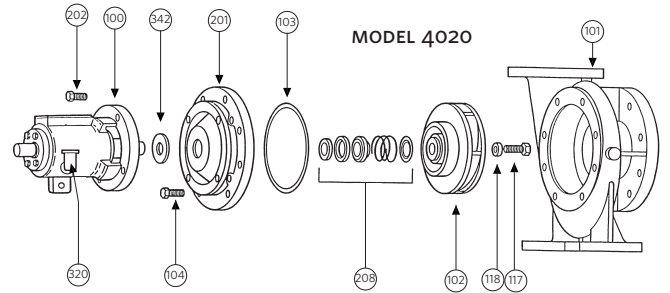
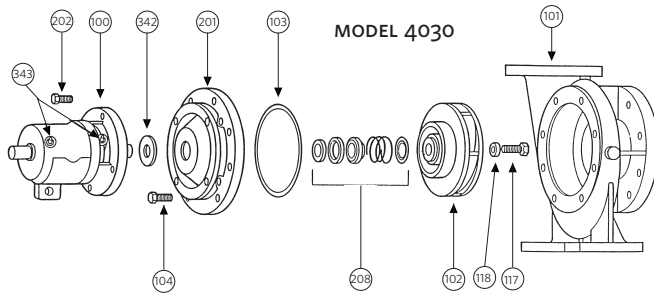

"S" SIZE 7/8" IMPELLER BORE - 1" SHAFT DIAMETER AT COUPLER

PUMP SIZE		CONSTRUCTION	NO. REQ'D SIZE	PART NUMBER		UPC NUMBER
B&G	ARMSTRONG			B&G	ARMSTRONG	
1 1/4AB TO 4AB	1 1/4D TO 4D	ALL	8 REQ'D 3/8-16NCx1"	P40020	911121-108	6 72807 01282 3
1 1/4BB TO 5BB	1 1/4E TO 5E	ALL	12 REQ'D 7/16-14NCx1"	S03980	911123-108	6 72807 04727 6

"M" SIZE 1 1/4" IMPELLER BORE - 1 1/4" SHAFT DIAMETER AT COUPLER

PUMP SIZE		CONSTRUCTION	NO. REQ'D SIZE	PART NUMBER		UPC NUMBER
B&G	ARMSTRONG			B&G	ARMSTRONG	
1 1/4AB TO 4AB	1 1/4D TO 4D	ALL	8 REQ'D 3/8-16x2 5/8"	P44250	911121-120	6 72807 28954 6
1 1/4BB TO 6BB	1 1/4E TO 6E	ALL	12 REQ'D 7/16-14NCx1 1/4"	P03470	911123-110	6 72807 28976 8
2C TO 8C	2G TO 8G	ALL	12 REQ'D 1/2-13NCx1 1/2"	P13780	911125-116	6 72807 29001 6

102

Item 342 water slinger

MODEL NUMBER

B&G MODEL 1510B
B&G UNIVERSAL

ARMSTRONG MODEL 4030
ARMSTRONG MODEL 4020

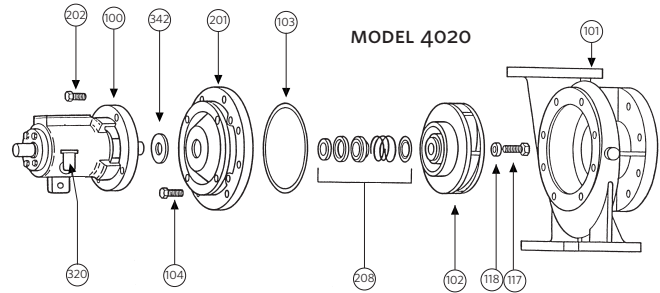
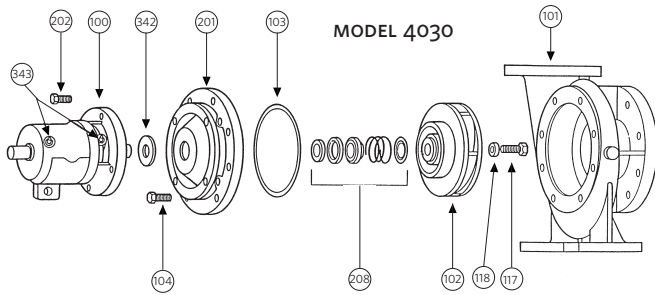

PUMP SHAFT DIAMETER	PART NUMBER		UPC NUMBER
	B&G	ARMSTRONG	
1 1/4"	PW - 6286	406622-000	6 72807 04736 8
1 5/8"	PW - 8286	419315-000	6 72807 05499 1

Item 202 coverplate capscrew

"S" SIZE 7/8" IMPELLER BORE - 1" SHAFT DIAMETER AT COUPLER

PUMP SIZE		CONSTRUCTION	NO. REQ'D SIZE	PART NUMBER		UPC NUMBER
B&G	ARMSTRONG			B&G	ARMSTRONG	
1 1/4AB TO 4AB	1 1/4D TO 4D	ALL	4 REQ'D	P40020	911121-108	6 72807 28948 5
1 1/4BB TO 5BB	1 1/4E TO 5E					

"M" SIZE 1 1/4" IMPELLER BORE - 1 1/4" SHAFT DIAMETER AT COUPLER

PUMP SIZE		CONSTRUCTION	NO. REQ'D SIZE	PART NUMBER		UPC NUMBER
B&G	ARMSTRONG			B&G	ARMSTRONG	
1 1/4AB TO 4AB	1 1/4D TO 4D	ALL	4 REQ'D	P55420	911121-110	6 72807 28949 2
1 1/4BB TO 6BB	1 1/4E TO 6E					
2C TO 8C	2G TO 8G		3/8-16x1 1/4"			

Item 401 coupler selection table (Woods type)

MODEL NUMBER

B&G MODEL 1510B
B&G UNIVERSAL

ARMSTRONG MODEL 4030
ARMSTRONG MODEL 4020

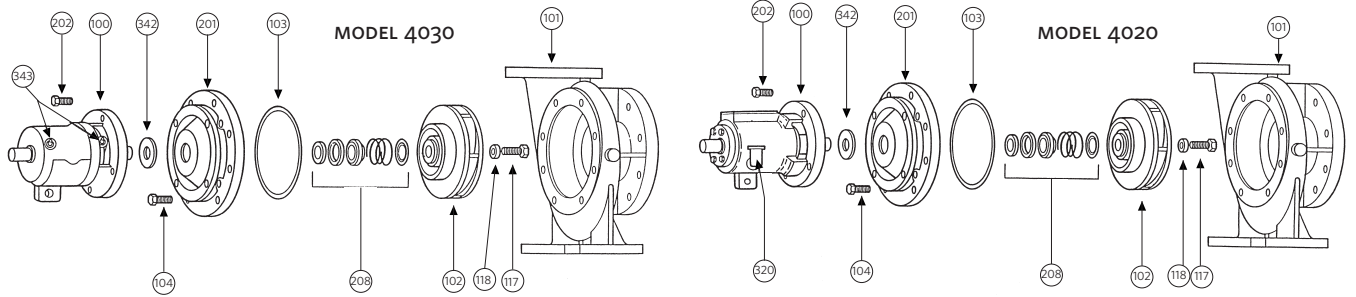

PUMP SHAFT SIZE	MOTOR FRAME SIZE	MOTOR SHAFT SIZE	COUPLER PART NUMBER		WOODS SIZE	UPC NUMBER
			B&G	ARMSTRONG		
1"	56	5/8"	186868	819340-002	4J	6 72807 28641 5
1"	143T - 145T 182 - 184	7/8"	186869	819341-002	4J	6 72807 28642 2
1"	182T - 184T 213 - 215	1 1/8"	186870	819342-002	5J	6 72807 28643 9
1"	213T - 215T 254U - 256U	1 3/8"	186871	819344-002	6J	6 72807 28645 3
1"	254T - 256T 284U	1 5/8"	186873	819347-002	7J	6 72807 28647 7
1 1/4"	254U - 256U 213T - 215T	1 3/8"	186872	819344-012	6J	6 72807 28646 0
1 1/4"	254T - 256T 284U 284T - 286T	1 5/8"	P63239	819348-002	7J	6 72807 28648 4
1 1/4"	324U	1 7/8"	P63242	819349-002	8J	6 72807 28649 1
1 1/4"	324T - 326T	2 1/8"	P63245	819350-002	9E	6 72807 28650 7

104

Item 407 insert selection table (Woods type)

INSERT SIZE "WOODS"	PART NUMBER		UPC NUMBER
	B&G	ARMSTRONG	
4J	P78804	875000-801	 6 72807 28818 1
5J	P78729	875000-802	 6 72807 28819 8
6J	P78791	875000-803	 6 72807 28820 4
7J	P78792	875000-804	 6 72807 28821 1
9J	P78796	875000-807	 6 72807 28823 5

MOTOR MOUNTED PUMP PARTS CROSS REFERENCE-CLOSE COUPLED

Armstrong 4280 old style, tangential, motor mounted pumps

MODEL NUMBER

B&G MODEL 1531

ARMSTRONG 4280 OLD STYLE, TANGENTIAL, MOTOR

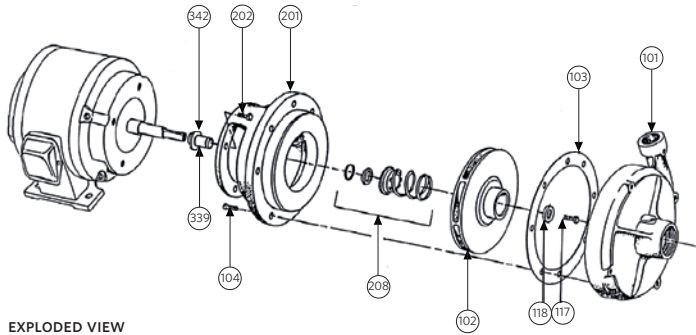

EXPLODED VIEW

ITEM	DESCRIPTION	ITEM	DESCRIPTION	ITEM	DESCRIPTION
101	VOLUTE	117	IMPELLER CAPSCREW	208	MECHANICAL SEAL ASSEMBLIES
102	IMPELLER	118	IMPELLER WASHER	339	SHAFT SLEEVE KIT
103	VOLUTE GASKET	201	MOTOR/PUMP BRACKET	342	WATER SLINGER
104	VOLUTE CAPSCREW	202	M/P BRACKET CAPSCREW		

106

Armstrong model 4280 power frames, all speeds

MODEL NUMBER

B&G MODEL 1531B

ARMSTRONG MODEL 4280 POWER FRAMES, ALL SPEEDS

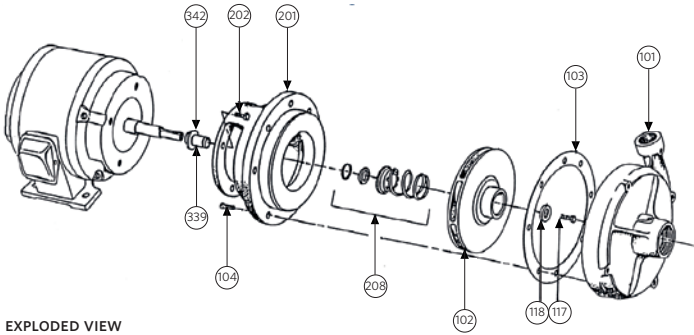

EXPLODED VIEW

MOTOR HP AND MOTOR SPEED	1800RPM	1/2, 3/4 & 1	1 1/2 & 2	3	5	7 1/2	10	15	20	25	30	40	50
	3600RPM	1 1/2	2 & 3	5	7 1/2	10	15	20	25	30	40	50	60
FRAME SIZE	1954 RERATE	182C	184C	213C	215C	254UC	256UC	284UC	286UC	324UC	326SC	-	-
	1964 RERATE	143JM	145JM	182JM	184JM	213JM	215JM	254JM	256JM	284JM	286JM	-	-
	WEST COAST	-	-	-	-	-	-	254TCZ	256TCZ	284TCZ	286TCZ	324TCZ	326TCZ
	1972 RERATE	-	-	-	-	-	-	254JP	256JP	284JP	286JP	324JP	326JP

PUMP SIZE

B&G	ARMSTRONG												
1 1/4 AB	1 1/4 D	S	S	S	S	S	-	-	-	-	-	-	-
1 1/2 AB	1 1/2 D	S	S	S	S	S	S	-	-	-	-	-	-
2 AB	2 D	S	S	S	S	S	S	-	-	-	-	-	-
2 1/2 A	2 1/2 D	S	S	S	S	S	S	M	-	-	-	-	-
3 A	3 D	S	S	S	S	S	S	M	M	-	-	-	-
4 AB	4 D	-	S	S	S	S	S	M	M	M	M	-	-
1 1/4 BB	1 1/4 E	-	S	S	S	S	S	M	M	M	-	-	-
1 1/2 BB	1 1/2 E	-	S	S	S	S	S	M	M	M	M	-	-
2 BB	2 E	-	S	S	S	S	-	M	M	M	M	M	-
2 1/2 BB	2 1/2 E	-	-	S	S	S	-	-	-	-	-	-	-
3 BB	3 E	-	-	-	S	S	-	-	-	-	-	-	-
4 BB	4 E	-	-	-	S	S	S	M	-	-	-	-	-
5 BB	5 E	-	-	-	-	S	S	M	M	-	-	-	-
6 BB	6 E	-	-	-	-	-	-	M	M	M	-	-	-

NOTE: S" Designation - 7/8" impeller bore, 1 1/4" mechanical seal
M" Designation - 1 1/4" impeller bore, 1 5/8" mechanical seal

Item 101 volute

MODEL NUMBER

B&G MODEL 1531B

ARMSTRONG MODEL 4280

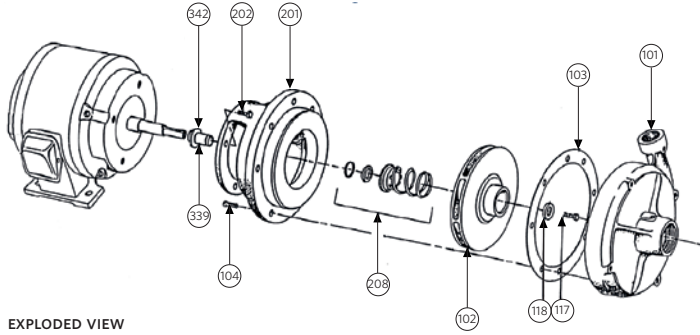

PUMP SIZE		MATERIAL	PART NUMBER		UPC CODE
B&G	ARMSTRONG		B&G	ARMSTRONG	
1 ¼AB	1 ¼D	CAST IRON	P41200**	415290-011	6 72807 05313 0
1 ¼AB	1 ¼D	BRONZE	P41220**	415290-041	6 72807 05315 4
1 ½AB	1 ½D	CAST IRON	P41690	415293-011	6 72807 05325 3
1 ½AB	1 ½D	BRONZE	P41710	415293-041	6 72807 05328 4
2AB	2D	CAST IRON	P42070**	425141-011	6 72807 05617 9
2AB	2D	BRONZE	P42090**	425141-041	6 72807 05619 3
2 ½A	2 ½D	CAST IRON	P42360**	425143-011	6 72807 05625 4
2 ½A	2 ½D	BRONZE	P42360**	425143-011	6 72807 05625 4
3A***	3D	CAST IRON	PW-121C1**	425145-011	6 72807 05631 5

PUMP SIZE		MATERIAL	PART NUMBER		UPC CODE
B&G	ARMSTRONG		B&G	ARMSTRONG	
3A***	3D	BRONZE	PWB-121**	425145-041	N/A
4AB	4D	CAST IRON	P43250**	415299-011	
4AB	4D	BRONZE	P55280**	415299-041	
1 ¼BB	1 ¼E	CAST IRON	P41410**	416168-011	
1 ¼BB	1 ¼E	BRONZE	P41430**	416168-041	
1 ½BB	1 ½E	CAST IRON	P41780	425147-011	
2BB	2E	CAST IRON	P14120**	419153-011	
2BB	2E	BRONZE	P42160**	419153-041	N/A
2 ½B	2 ½E	CAST IRON	P42480	415297-011	
2 ½B	2 ½E	BRONZE	P55190**	415297-041	
3BB	3E	CAST IRON	P42740	416180-011	
3BB	3E	BRONZE	P42770	416180-041	
4BB	4E	CAST IRON	P43310**	415301-011	
4BB	4E	BRONZE	P55320**	415301-041	N/A

PUMP SIZE		MATERIAL	PART NUMBER		UPC CODE
B&G	ARMSTRONG		B&G	ARMSTRONG	
5BB	5E	CAST IRON	P43620**	415303-011	 6 72807 05354 3
5BB	5E	BRONZE	P55360**	415303-041	 6 72807 05355 0
6BB	6E	CAST IRON	P43730**	416188-011	 6 72807 05388 8
2C	2G	CAST IRON	P42865	419544-011	 6 72807 05574 5
2C	2G	BRONZE	-	419544-041	N/A
3C	3G	CAST IRON	P42880	419003-011	 6 72807 05397 0
3C	3G	BRONZE	-	419003-041	N/A
4C	4G	BRONZE	-	419004-041	N/A
6C	6G	CAST IRON	P43810	419542-011	 6 72807 05566 0
6C	6G	BRONZE	-	419542-041	N/A

NOTE: ** These Volute are no longer available from B&G. "STOCK AT ARMSTRONG"

***For Pumps built prior to 1964 (Serial No. 00) only, use only with Impeller Part numbers 411868-011 & 411868-041 (7/8" Bore) and 419234-011 & 419234-041 (1 1/4" Bore).

110

Item 201 Impeller 7/8" bore

MODEL NUMBER



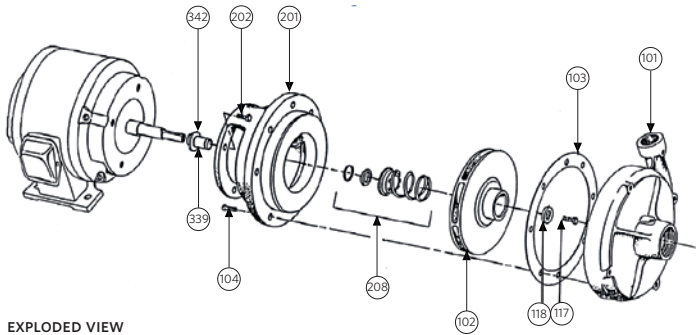

B&G MODEL 1531B

ARMSTRONG MODEL 4280



EXPLODED VIEW

PUMP SIZE		MATERIAL	PART NUMBER		IMPELLER BORE	MAX. DIA.	UPC CODE
B&G	ARMSTRONG		B&G	ARMSTRONG			
1 1/4 AB	1 1/4 D	BRONZE	P46630	411852-041	7/8"	7"	6 72807 05243 0
1 1/4 AB	1 1/4 D	CAST IRON	P46510	411852-011	7/8"	7"	6 72807 05241 6
1 1/2 AB	1 1/2 D	BRONZE	P47950	411860-041	7/8"	7"	6 72807 05247 8
1 1/2 AB	1 1/2 D	CAST IRON	P47810	411860-011	7/8"	7"	6 72807 05245 4
2 AB	2 D	BRONZE	P47950	411860-041	7/8"	7"	6 72807 05247 8
2 AB	2 D	CAST IRON	P47810	411860-011	7/8"	7"	6 72807 05245 4
2 1/2 A	2 1/2 D	BRONZE	P49000	406642-041	7/8"	7"	6 72807 04745 0
2 1/2 A	2 1/2 D	CAST IRON	P48770	406642-011	7/8"	7"	6 72807 04743 6
3 A***	3 D	BRONZE	P49480	411868-041	7/8"	7"	6 72807 05252 2

PUMP SIZE		MATERIAL	PART NUMBER		IMPELLER BORE	MAX. DIA.	UPC CODE
B&G	ARMSTRONG		B&G	ARMSTRONG			
3A***	3D	CAST IRON	P49500	411868-011	7/8"	7"	
4 AB	4D	BRONZE	P56140	411874-041	7/8"	7"	
4 AB	4D	CAST IRON	P50270	411874-041	7/8"	7"	
1 1/4 BB	1 1/4 E	BRONZE	P78523	407922-041	7/8"	9 1/2"	
1 1/4 BB	1 1/4 E	CAST IRON	P78253	407922-011	7/8"	9 1/2"	
1 1/2 BB	1 1/2 E	BRONZE	P78523	407922-041	7/8"	9 1/2"	
1 1/2 BB	1 1/2 E	CAST IRON	P78253	407922-011	7/8"	9 1/2"	
2 BB	2 E	BRONZE	P78525	411881-041	7/8"	9 1/2"	
2 BB	2 E	CAST IRON	P78486	411881-011	7/8"	9 1/2"	
2 1/2 B	2 1/2 E	BRONZE	P78525	411881-041	7/8"	9 1/2"	
2 1/2 B	2 1/2 E	CAST IRON	P78486	411881-011	7/8"	9 1/2"	
3 BB	3 E	BRONZE	P49620	419465-041	7/8"	9 1/2"	
3 BB	3 E	CAST IRON	P49600	419465-011	7/8"	9 1/2"	
4 BB	4 E	BRONZE	P50550	411940-041	7/8"	9 1/2"	

112

PUMP SIZE		MATERIAL	PART NUMBER		IMPELLER BORE	MAX. DIA.	UPC CODE
B&G	ARMSTRONG		B&G	ARMSTRONG			
4 BB	4E	CAST IRON	P50390	411940-011	7/8"	9 1/2"	6 72807 05273 7
5 BB	5 E	BRONZE	P50930	411941-041	7/8"	9 1/2"	6 72807 05279 9
5 BB	5 E	CAST IRON	P50910	411941-011	7/8"	9 1/2"	6 72807 05277 5

NOTE: ***For Pumps built prior to 1964 (Serial No. DD) only, use only with Casing Part numbers PW1-121C1 for C.I. or PW1-121C8 for A.B.

Item 201 Impeller 1 1/4" bore

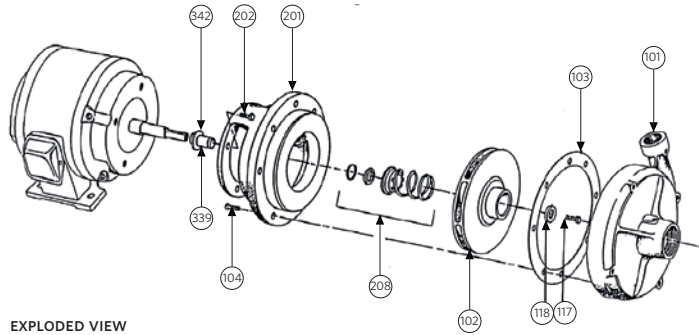

MODEL NUMBER
B&G MODEL 1531B
ARMSTRONG MODEL 4280



PUMP SIZE		MATERIAL	PART NUMBER		IMPELLER BORE	MAX. DIA.	UPC CODE
B&G	ARMSTRONG		B&G	ARMSTRONG			
1 1/2 A	1 1/2 D	BRONZE	P49040	419232-041	1 1/4"	7"	6 72807 05449 6
1 1/2 A	1 1/2 D	CAST IRON	P48980	419232-041	1 1/4"	7"	6 72807 05447 2
3A ***	3 D	BRONZE	P49480	419234-041	1 1/4"	7"	6 72807 05453 3
3A ***	3 D	CAST IRON	P49500	419234-011	1 1/4"	7"	6 72807 05451 9

PUMP SIZE		MATERIAL	PART NUMBER		IMPELLER BORE	MAX. DIA.	UPC CODE
B&G	ARMSTRONG		B&G	ARMSTRONG			
4 AB	4 D	BRONZE	P50310	419236-041	1 ¼"	7"	
4 AB	4 D	CAST IRON	P50290	419236-011	1 ¼"	7"	
1 ¼ BB	1 ¼ E	BRONZE	P78251	419238-041	1 ¼"	9 ½"	
1 ¼ BB	1 ¼ E	CAST IRON	P78522	419238-011	1 ¼"	9 ½"	
1 ½ BB	1 ½ E	BRONZE	P78251	419238-041	1 ¼"	9 ½"	
1 ½ BB	1 ½ E	CAST IRON	P78522	419238-011	1 ¼"	9 ½"	
2 BB	2 E	BRONZE	P78255	419239-041	1 ¼"	9 ½"	
2 BB	2 E	CAST IRON	P78257	419239-011	1 ¼"	9 ½"	
3 BB	3 E	BRONZE	P49640	419241-041	1 ¼"	9 ½"	
3 BB	3 E	CAST IRON	P49660	419241-011	1 ¼"	9 ½"	
4 BB	4 E	BRONZE	P50570	411940-041	1 ¼"	9 ½"	
4 BB	4 E	CAST IRON	P50330	411940-011	1 ¼"	9 ½"	
5 BB	5 E	BRONZE	P50970	419245-041	1 ¼"	9 ½"	

114

PUMP SIZE		MATERIAL	PART NUMBER		IMPELLER BORE	MAX. DIA.	UPC CODE
B&G	ARMSTRONG		B&G	ARMSTRONG			
5 BB	5 E	CAST IRON	P50950	419245-011	1 1/4"	9 1/2"	 6 72807 05475 5
6 BB	6 E	BRONZE	P51290	419247-041	1 1/4"	9 1/2"	 6 72807 05481 6
6 BB	6 E	CAST IRON	P51270	419247-011	1 1/4"	9 1/2"	 6 72807 05479 3

NOTE: **For Pumps built prior to 1964 (Serial No. DD) only, use only with Casing Part numbers PW1-121C1 for c.i. or PW1-121CB for A.B.

Motor / pump brackets



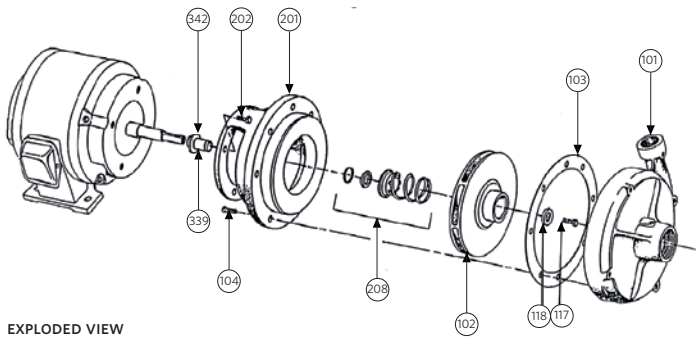

MODEL NUMBER

B&G MODEL 1531B

ARMSTRONG MODEL 4280



EXPLODED VIEW

PUMP SIZE		MOTOR FRAME SIZE	SEAL SIZE	CONSTRUCTION	PART NUMBER		UPC CODE
B&G	ARMSTRONG				B&G	ARMSTRONG	
1 1/4AB TO 4AB	1 1/4D TO 4D	143T-145T 143JM-145JM 182-184 182JM-184JM	1 1/4"	BF-A1	186526	409026-012	 6 72807 04802 0
1 1/4AB TO 4AB	1 1/4D TO 4D	143T-145T 143JM-145JM 182-184 182JM-184JM	1 1/4"	AB	P56929	409026-042	 6 72807 04806 8
1 1/4AB TO 4AB	1 1/4D TO 4D	213-215 182T-184T 254U-256U 213T-215T 213JM-215JM	1 1/4"	BF-A1	186528	406931-012	 6 72807 04763 4
1 1/4AB TO 4AB	1 1/4D TO 4D	213-215 182T-184T 254U-256U 213T-215T 213JM-215JM	1 1/4"	AB	P56939	406931-042	 6 72807 04766 5

PUMP SIZE		MOTOR FRAME SIZE	SEAL SIZE	CONSTRUCTION	PART NUMBER		UPC CODE
B&G	ARMSTRONG				B&G	ARMSTRONG	
1 1/4BB TO 5BB	1 1/4E TO 5E	143T-145T 143JM-145JM 182-184 182JM-184JM	1 1/4"	BF-AI	186533	409023-012	 6 72807 04798 6
1 1/4BB TO 5BB	1 1/4E TO 5E	143JM-145JM 182-184 182JM-184JM	1 1/4"	AB	P56969	409023-042	 6 72807 04800 6
1 1/4BB TO 5BB	1 1/4E TO 5E	213-215 182T-184T 254U-256U 213T-215T 213JM-215JM	1 1/4"	BF-AI	186530	406948-012	 6 72807 04778 8
1 1/4AB TO 4AB	1 1/4D TO 4D	213-215 182T-184T 254U-256U 213T-215T 213JM-215JM	1 1/4"	AB	P56949	406953-042	 6 72807 04783 2
1 1/4AB TO 4AB	1 1/4D TO 4D	254T-256T 254JP-256JP	1 5/8"	BF-AI	P77076	425392-012	 6 72807 05737 4
1 1/4AB TO 4AB	1 1/4D TO 4D	254T-256T 254JP-256JP	1 5/8"	AB	P77073	425392-042	 6 72807 05739 8
1 1/4AB TO 4AB	1 1/4D TO 4D	284U-286U 284T-286T	1 5/8"	BF-AI	P53690	419164-012	 6 72807 05419 9
1 1/4AB TO 4AB	1 1/4D TO 4D	284U-286U 284T-286T	1 5/8"	AB	P53710	419168-042	 6 72807 05428 1
1 1/4AB TO 4AB	1 1/4D TO 4D	284JP-286JP 324U-326U 324T-326T 324JP-326JP 364T-365T 364JP-365JP 404-405	1 5/8"	BF-AI	P53880	419165-012	 6 72807 05422 9
1 1/4AB TO 4AB	1 1/4D TO 4D	284JP-286JP 324U-326U 324T-326T 324JP-326JP 364T-365T 364JP-365JP 404-405	1 5/8"	AB	P53900	419165-042	N/A

PUMP SIZE		MOTOR FRAME SIZE	SEAL SIZE	CONSTRUCTION	PART NUMBER		UPC CODE
B&G	ARMSTRONG				B&G	ARMSTRONG	
1 1/4BB TO 6BB	1 1/4E TO 6E	254T-256T 254JP-256JP	1 5/8"	BF-AI	P77166	425393-012	 6 72807 05740 4
1 1/4BB TO 6BB	1 1/4E TO 6E	254T-256T 254JP-256JP	1 5/8"	AB	P77169	425393-042	 6 72807 05741 1
1 1/4BB TO 6BB	1 1/4E TO 6E	284U-286U 284T-286T	1 5/8"	BF-AI	P53020	419166-012	 6 72807 05425 0
1 1/4BB TO 6BB	1 1/4E TO 6E	284U-286U 284T-286T	1 5/8"	AB	P53040	419170-042	 6 72807 05430 4
1 1/4BB TO 6BB	1 1/4E TO 6E	284JP-286JP 324U-326U 324T-326T 324JP-326JP 364T-365T 364JP-365JP 404-405	1 5/8"	BF-AI	P53500	411883-012	 6 72807 05262 1
1 1/4BB TO 6BB	1 1/4E TO 6E	284JP-286JP 324U-326U 324T-326T 324JP-326JP 364T-365T 364JP-365JP 404-405	1 5/8"	BF-AI	P53540	419171-042	 6 72807 05431 1

Item 117 Impeller CAPSCREWS

MODEL NUMBER

B&G MODEL 1531B

ARMSTRONG MODEL 4280

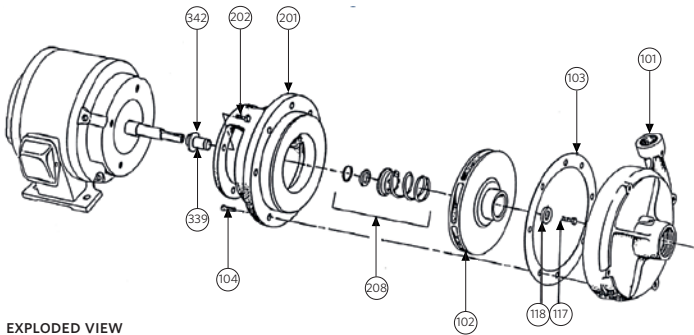

EXPLODED VIEW

MOTOR FRAME SIZE	IMPELLER BORE	CONSTRUCTION	PART NUMBER		UPC CODE
			B&G	ARMSTRONG	
143T TO 215T 143JM TO 215JM 254U TO 256U	7/8"	BF-AI	P52320	911900-108	N/A
143T TO 215T 143JM TO 215JM 254U TO 256U	7/8"	AB	P52350	911900-114	6 72807 29208 9
254T TO 365T 254JP TO 365JP 284U TO 326U	1 1/4"	BF-AI	P13800	911900-113	6 72807 29207 2
254T TO 365T 254JP TO 365JP 284U TO 326U	1 1/4"	AB	P13800	911900-115	6 72807 29209 6

Item 118 Impeller WASHERS

MOTOR FRAME SIZE	IMPELLER BORE	CONSTRUCTION	PART NUMBER		UPC CODE
			B&G	ARMSTRONG	
143T TO 215T 143JM TO 215JM 254U TO 256U	7/8"	BF-AI	P46930	406614-000	N/A
143T TO 215T 143JM TO 215JM 254U TO 256U	7/8"	AB	P46380	406677-000	6 72807 04748 1
254T TO 365T 254JP TO 365JP 284U TO 326U	1 1/4"	BF-AI	P51250	425742-003	6 72807 06125 8
254T TO 365T 254JP TO 365JP 284U TO 326U	1 1/4"	AB	P51230	425742-003	672807061258

118

Item 103 volute gasket

MODEL NUMBER

B&G MODEL 1531B

ARMSTRONG MODEL 4280

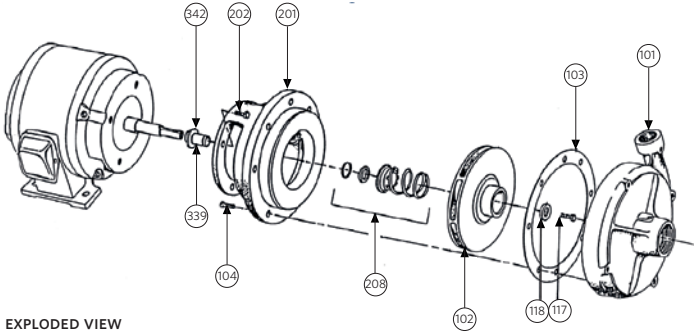





EXPLODED VIEW

PUMP SIZE		SEAL SIZE	CONSTRUCTION	PART NUMBER		UPC CODE
B&G	ARMSTRONG			B&G	ARMSTRONG	
1 ¼AB TO 4AB	1 ¼D TO 4D	1 ¼"	BF-AI-AB	P57700	106592-000	6 72807 01282 3
1 ¼BB TO 5BB	1 ¼E TO 5E	AND	BF-AI-AB	P48690	406604-000	6 72807 04727 6
3A TO 4AB	2D TO 4D		BF-AI-AB	P57700	106592-000	6 72807 01282 3
1 ¼BB TO 6BB	1 ¼E TO 6E	1 ⅝"	BF-AI-AB	P48690	406604-000	6 72807 04727 6

Item 208 mechanical seal assemblies

B&G PART NUMBER		ARMSTRONG PART NUMBER	SEAL SIZE	CONSTRUCTION		UPC CODE
OLD	NEW			B&G	ARMSTRONG	
#1 KIT	186862	825458-001	1 ¼"	BF-AB	BF-AB-AI	6 72807 28676 7
#4 KIT	186860	825458-001	1 ¼"	AI	BF-AB-AI	6 72807 28676 7
#8 KIT	186543	811339-000	1 ⅝"	BF-AB	BF-AB	6 72807 28376 6
#9 KIT	186544	811866-000	1 ⅝"	AI	AI	6 72807 28395 7

Item 339 shaft sleeve and spacer kit

MOTOR FRAME SIZE	B&G KIT PART NUMBER	SEAL SIZE	CONSTRUCTION	ARMSTRONG PART NUMBER	UPC CODE
				B&G	
143T TO 215T 143JM TO 215JM 254U TO 256U	185024	1 ¼"	BF-AB	835085-001	 6 72807 28753 5
143T TO 215T 143JM TO 215JM 254U TO 256U	185025	1 ¼"	AI	835085-002	 6 72807 28754 2
254T TO 365T 254JP TO 365JP 284U TO 326U	185021	1 ⅝"	BF-AB	810150-152	 6 72807 28367 4
254T TO 365T 254JP TO 365JP 284U TO 326U	185022	1 ⅝"	AI	810150-153	 6 72807 28368 1

120

Item 104 volute capscrew

MODEL NUMBER

B&G MODEL 1531B

ARMSTRONG MODEL 4280

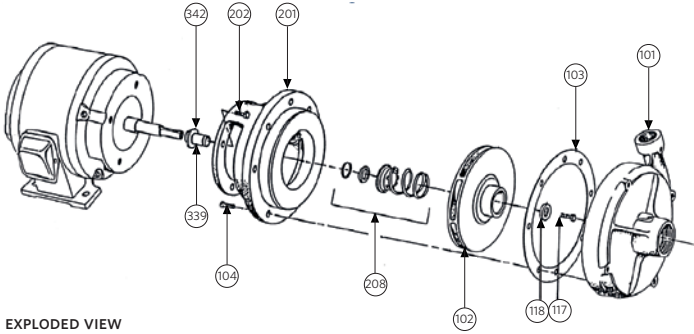



EXPLODED VIEW

PUMP SIZE		CONSTRUCTION	NO. REQ'D SIZE	PART NUMBER		UPC CODE
B&G	ARMSTRONG			B&G	ARMSTRONG	
1 1/4AB TO 4AB	1 1/4D TO 4D	ALL	8 REQ'D 3/8-16NCx1"	P40020	911121-108	6 72807 28948 5
1 1/4BB TO 6BB	1 1/4E TO 6E	ALL	12 REQ'D 7/16-14NCx1"	P03470	911123-108	6 72807 28975 1

Item 207 motor capscrew

MOTOR FRAME SIZE	CONSTRUCTION	NO. REQ'D SIZE	PART NUMBER		UPC CODE
			B&G	ARMSTRONG	
143T-145T 143JM-145JM 182-184 182JM-184JM	ALL	4 REQ'D 3/8-16NCx1 1/4"	P52320	911121-110	6 72807 28949 2
213C-256UC 213T-256T 213JM-215JM 254U-256U 284U-286U 284JP-286JP	ALL	4 REQ'D 1/2-13NCx1 1/4"	K03600	911125-110	6 72807 28998 0
324UC-405UC 324JP-326JP 404-405	ALL	4 REQ'D 5/8-11NCx1 1/4"	P54800	911129-110	6 72807 29042 9

Item 342 water slinger

PUMP SHAFT DIAMETER	PART NUMBER		UPC CODE
	B&G	ARMSTRONG	
1 1/4"	PW - 6286	406622-000	 6 72807 04736 8
1 5/8"	PW - 8286	419315-000	 6 72807 05499 1

CROSS REFERENCE
CLOSE COUPLED

Motor Mounted
Pump Parts

VIL CENTRIFUGAL PUMPS CROSS REFERENCE

Armstrong series 4380 BF

MODEL NUMBER						
TEEL / GRAINGER 4P934, 4P935, 4P936, 4P937, 4P938			ARMSTRONG SERIES 4380 BF			
DESCRIPTION		2X2X8	3X3X8	4X4X8	4X4X10	6X6X8
CASING	PART NUMBER	427027-011	427151-011	427053-011	427063-011	427055-011
	UPC NUMBER	N/A	672807093686	672807087555	672807088590	672807087814
MOTOR		3HP/1750/60 /3/208/230 /460-182JM FRAME	5HP/1750/60 /3/208/230 /460-184JM FRAME	7.5HP/1750 /60/3/208/ 230/460-213JP FRAME	10HP/1750/60 /3/208/230 /460-215JP FRAME	15HP/1750/60 /3/208/230/ 460-254JM FRAME
MOTOR BRACKET/ ADAPTER	PART NUMBER	426749-011	426749-011	426750-011	426754-015	426751-015
	UPC CODE	 6 72807 08174 4		672807081829	672807082277	672807081959
IMPELLER	PART NUMBER	427121-041 8" MAXIMUM OD.	427129-041 8" MAXIMUM OD.	427138-041 8" MAXIMUM OD.	427150-041 10" MAXIMUM OD.	427140-041 8" MAXIMUM OD.
	UPC CODE	672807092474	672807092955	672807093341	672807093648	672807093464
SEAL KIT	PART NUMBER	975000-991	975000-991	975000-993	975000-993	975000-993
	UPC CODE	 6 72807 32661 6		 6 72807 32663 0		
SLEEVE AND SPACER	PART NUMBER	810150-150	810150-150	810150-152	810150-152	810150-154
	UPC CODE	 6 72807 28365 0		 6 72807 28367 4		 6 72807 28369 8
CASING GASKET	PART NUMBER	426401-003	426401-003	426401-003	426401-004	426401-004
	UPC CODE	 6 72807 07143 1			 6 72807 07144 8	
WATER SLINGER	PART NUMBER	406622-000	406622-000	406622-000	406622-000	406622-000
	UPC CODE	 6 72807 04736 8				

DESCRIPTION	2X2X8	3X3X8	4X4X8	4X4X10	6X6X8
PART NUMBER	425742-001	425742-001	425742-003	425742-003	425742-003
IMPELLER WASHER					
UPC CODE	6 72807 06123 4		6 72807 06125 8		
PART NUMBER	911900-114	911900-114	911900-119	911900-119	911900-119
IMPELLER CAPSCREW					
UPC CODE	6 72807 29208 9		6 72807 29212 6		















UPC CODE			
			
			
			

Armstrong "D" series 4360 BF









MODEL NUMBER	
TEEL / GRAINGER 4P930, 4P931, 4P932, 4P933	ARMSTRONG "D" SERIES 4360 BF

DESCRIPTION	1 ½ D		2 D		3 D	
PART NUMBER	116397-011 C.I.	116397-041 BRONZE	116174-011 C.I.	116174-041 BRONZE	116646-011 C.I.	116646-041 BRONZE
CASING						
UPC NUMBER	672807024918	672807024932	672807023898	672807023928	672807028640	672807028664
PART NUMBER	426993-011 STEEL	426993-041 BRONZE	411860-011 STEEL	411860-041 BRONZE	426994-041 BRONZE	
IMPELLER 7/8" BORE						
UPC CODE	672807084714	672807084738	672807052454	672807052478	672807084752	

DESCRIPTION		1 ½ D		2 D		3 D	
FLANGE	PART NUMBER	104301-011 C.I.	104301-041 BRONZE	106074-011 C.I.	106074-041 BRONZE	133615-011 C.I.	133615-041 BRONZE
	UPC CODE	672807010683	672807010706	672807011413	672807011420		
FLANGE GASKETS	PART NUMBER	104034-000		116117-000		125606-106	
	UPC CODE	672807010553		672807023836			

UPC CODE			
 6 72807 02491 8 672807024918	 6 72807 02493 2 672807024932	 6 72807 02389 8 672807023898	 6 72807 02392 8 672807023928
 6 72807 02864 0 672807028640	 6 72807 02866 4 672807028664	 6 72807 08471 4 672807084714	 6 72807 08473 8 672807084738
 6 72807 05245 4 672807052454	 6 72807 05247 8 672807052478	 6 72807 08475 2 672807084752	 6 72807 01068 3 672807010683
 6 72807 01070 6 672807010706	 6 72807 01141 3 672807011413	 6 72807 01142 0 672807011420	 6 72807 01055 3 672807010553
 6 72807 02383 6 672807023836			

Common parts

DESCRIPTION	PART NUMBER	UPC NUMBER
CASING GASKET	106592-000	 6 72807 01282 3
SEAL KIT	825458-001	 6 72807 28676 7
SLEEVE AND SPACER	835085-001	 6 72807 28753 5
WATER SLINGER	406622-000	 6 72807 04736 8
IMPELLER WASHER	425742-001	 6 72807 06123 4
IMPELLER CAPSCREW	911900-114	 6 72807 29208 9
ADAPTER / MOTOR BRACKET	426991-011 (PUMPS BUILT PRIOR TO SERIAL NO. 99808) 426989-011 (PUMPS BUILT AFTER SERIAL NO. 99807)	 6 72807 08463 9
FLUSH LINE	1 EA. 997531-004 3/8" x 12" x .032 WALL COPPER TUBE 2 EA. 939001-114 3/8" x 1/4" NPT ELBOW	 6 72807 33901 2  6 72807 31123 0

SHELL AND TUBE HEAT EXCHANGERS CROSS REFERENCE

HEAT EXCHANGERS PART NUMBER		TUBE BUNDLE PART NUMBER		SHELL GASKET		HEAD GASKET	
GRAINGER	ARMSTRONG	GRAINGER	ARMSTRONG	PART NUMBER	UPC CODE	PART NUMBER	UPC CODE
2P861	WS-0403-2-1	2P862	RTB WS-0403-2-1	691300-001		691301-001	
2P863	WS-0404-2-1	2P864	RTB WS-0404-2-1	691300-001		691301-001	
2P865	WS-0603-2-1	2P866	RTB WS-0603-2-1	691300-002		691301-002	
2P867	WS-0604-2-1	2P868	RTB WS-0604-2-1	691300-002		691301-002	
2P869	WS-0605-2-1	2P870	RTB WS-0605-2-1	691300-002		691301-002	
2P871	WS-0804-2-1	2P872	RTB WS-0804-2-1	691300-003		691301-003	

TORONTO

23 BERTRAND AVENUE
TORONTO, ONTARIO
CANADA
M1L 2P3
+1 416 755 2291

BUFFALO

93 EAST AVENUE
NORTH TONAWANDA
NEW YORK
U.S.A. 14120-6594
+1 716 693 8813

BIRMINGHAM

HEYWOOD WHARF,
MUCKLOW HILL, HALESOWEN
WEST MIDLANDS
B62 8DJ, UNITED KINGDOM
+44 (0) 8444 145 145

MANCHESTER

WENLOCK WAY
MANCHESTER
UNITED KINGDOM
B62 8DJ
+44 (0) 8444 145 145

BANGALORE

#59, FIRST FLOOR, 3RD MAIN
MARGOSA ROAD
MALLESWARAM INDIA
560 003
+91 (80) 4149 2832

SHANGHAI

728, YAN AN XI ROAD
SUITE 6-1
SHANGHAI, 200050
P.R.C.
+021 3756 6696

**MAKING
ENERGY
MAKE
SENSE™**